



The RF MOSFET Line

RF Power Field Effect Transistors

N-Channel Enhancement-Mode Lateral MOSFETs

Designed for broadband commercial and industrial applications with frequencies up to 1.0 GHz. The high gain and broadband performance of these devices make them ideal for large-signal, common source amplifier applications in 26 volt base station equipment.

- Guaranteed Performance @ 880 MHz, 26 Volts
Output Power — 85 Watts PEP
Power Gain — 12 dB
Efficiency — 30%
Intermodulation Distortion — -28 dBc
- 100% Tested for Load Mismatch Stress at all Phase Angles with 5:1 VSWR @ 26 Vdc, 880 MHz, 85 Watts CW
- Excellent Thermal Stability
- Characterized with Series Equivalent Large-Signal Impedance Parameters
- Available in Tape and Reel. R3 Suffix = 250 Units per 56 mm, 13 Inch Reel.

MRF187
MRF187R3
MRF187SR3

1.0 GHz, 85 W, 26 V
LATERAL N-CHANNEL
BROADBAND
RF POWER MOSFETs

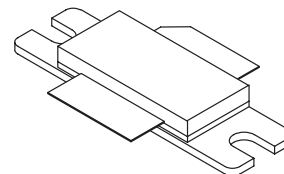

CASE 465-06, STYLE 1
NI-780
MRF187

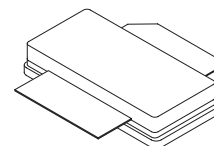

CASE 465A-06, STYLE 1
NI-780S
MRF187SR3

MAXIMUM RATINGS

Rating	Symbol	Value	Unit
Drain-Source Voltage	V_{DSS}	65	Vdc
Drain-Gate Voltage ($R_{GS} = 1 \text{ M}\Omega$)	V_{DGR}	65	Vdc
Gate-Source Voltage	V_{GS}	± 20	Vdc
Drain Current — Continuous	I_D	15	Adc
Total Device Dissipation @ $T_C \geq 25^\circ\text{C}$ Derate above 25°C	P_D	250 1.43	Watts $W/^\circ\text{C}$
Storage Temperature Range	T_{stg}	-65 to +200	$^\circ\text{C}$
Operating Junction Temperature	T_J	200	$^\circ\text{C}$

THERMAL CHARACTERISTICS

Characteristic	Symbol	Max	Unit
Thermal Resistance, Junction to Case	$R_{\theta JC}$	0.70	$^\circ\text{C/W}$

NOTE – **CAUTION** – MOS devices are susceptible to damage from electrostatic charge. Reasonable precautions in handling and packaging MOS devices should be observed.

**ELECTRICAL CHARACTERISTICS** ($T_C = 25^\circ\text{C}$ unless otherwise noted)

Characteristic	Symbol	Min	Typ	Max	Unit
OFF CHARACTERISTICS					
Drain–Source Breakdown Voltage ($V_{GS} = 0\text{ Vdc}$, $I_D = 50\ \mu\text{Adc}$)	$V_{(BR)DSS}$	65	—	—	Vdc
Zero Gate Voltage Drain Leakage Current ($V_{DS} = 26\text{ Vdc}$, $V_{GS} = 0\text{ Vdc}$)	I_{DSS}	—	—	1	μAdc
Gate–Source Leakage Current ($V_{GS} = 20\text{ Vdc}$, $V_{DS} = 0\text{ Vdc}$)	I_{GSS}	—	—	1	μAdc
ON CHARACTERISTICS					
Gate Quiescent Voltage ($V_{DS} = 26\text{ Vdc}$, $I_D = 550\text{ mAdc}$)	$V_{GS(Q)}$	3	—	5	Vdc
Drain–Source On–Voltage ($V_{GS} = 10\text{ Vdc}$, $I_D = 3\text{ Adc}$)	$V_{DS(on)}$	—	0.40	0.55	Vdc
Forward Transconductance ($V_{DS} = 10\text{ Vdc}$, $I_D = 5\text{ Adc}$)	g_{fs}	—	2	—	S
DYNAMIC CHARACTERISTICS					
Input Capacitance (Includes Internal Input MOSCap) ($V_{DS} = 26\text{ Vdc}$, $V_{GS} = 0$, $f = 1\text{ MHz}$)	C_{iss}	—	295	—	pF
Output Capacitance ($V_{DS} = 26\text{ Vdc}$, $V_{GS} = 0$, $f = 1\text{ MHz}$)	C_{oss}	—	85	—	pF
Reverse Transfer Capacitance ($V_{DS} = 26\text{ Vdc}$, $V_{GS} = 0$, $f = 1\text{ MHz}$)	C_{rss}	—	10	—	pF
FUNCTIONAL TESTS (In Motorola Test Fixture, 50 ohm system)					
Two–Tone Common–Source Amplifier Power Gain ($V_{DD} = 26\text{ Vdc}$, $P_{out} = 85\text{ W PEP}$, $I_{DQ} = 550\text{ mA}$, $f_1 = 880.0\text{ MHz}$, $f_2 = 880.1\text{ MHz}$)	G_{ps}	12	13	—	dB
Two–Tone Drain Efficiency ($V_{DD} = 26\text{ Vdc}$, $P_{out} = 85\text{ W PEP}$, $I_{DQ} = 550\text{ mA}$, $f_1 = 880.0\text{ MHz}$, $f_2 = 880.1\text{ MHz}$)	η_D	30	33	—	%
3rd Order Intermodulation Distortion ($V_{DD} = 26\text{ Vdc}$, $P_{out} = 85\text{ W PEP}$, $I_{DQ} = 550\text{ mA}$, $f_1 = 880.0\text{ MHz}$, $f_2 = 880.1\text{ MHz}$)	IMD	—	–31	–28	dBc
Input Return Loss ($V_{DD} = 26\text{ Vdc}$, $P_{out} = 85\text{ W PEP}$, $I_{DQ} = 550\text{ mA}$, $f_1 = 880.0\text{ MHz}$, $f_2 = 880.1\text{ MHz}$)	IRL	9	15	—	dB
Two–Tone Common–Source Amplifier Power Gain ($V_{DD} = 26\text{ Vdc}$, $P_{out} = 85\text{ W PEP}$, $I_{DQ} = 550\text{ mA}$, $f_1 = 865.0\text{ MHz}$, $f_2 = 865.1\text{ MHz}$ and $f_1 = 895.0\text{ MHz}$, $f_2 = 895.1\text{ MHz}$)	G_{ps}	—	13	—	dB
Two–Tone Drain Efficiency ($V_{DD} = 26\text{ Vdc}$, $P_{out} = 85\text{ W PEP}$, $I_{DQ} = 550\text{ mA}$, $f_1 = 865.0\text{ MHz}$, $f_2 = 865.1\text{ MHz}$ and $f_1 = 895.0\text{ MHz}$, $f_2 = 895.1\text{ MHz}$)	η_D	—	33	—	%
3rd Order Intermodulation Distortion ($V_{DD} = 26\text{ Vdc}$, $P_{out} = 85\text{ W PEP}$, $I_{DQ} = 550\text{ mA}$, $f_1 = 865.0\text{ MHz}$, $f_2 = 865.1\text{ MHz}$ and $f_1 = 895.0\text{ MHz}$, $f_2 = 895.1\text{ MHz}$)	IMD	—	–31	—	dBc
Input Return Loss ($V_{DD} = 26\text{ Vdc}$, $P_{out} = 85\text{ W PEP}$, $I_{DQ} = 550\text{ mA}$, $f_1 = 865.0\text{ MHz}$, $f_2 = 865.1\text{ MHz}$ and $f_1 = 895.0\text{ MHz}$, $f_2 = 895.1\text{ MHz}$)	IRL	—	12	—	dB
Output Mismatch Stress ($V_{DD} = 26\text{ Vdc}$, $P_{out} = 85\text{ W CW}$, $I_{DQ} = 550\text{ mA}$, $f = 880\text{ MHz}$, $V_{SWR} = 5:1$, All Phase Angles at Frequency of Tests)	Ψ	No Degradation In Output Power Before and After Test			



ARCHIVED 2005

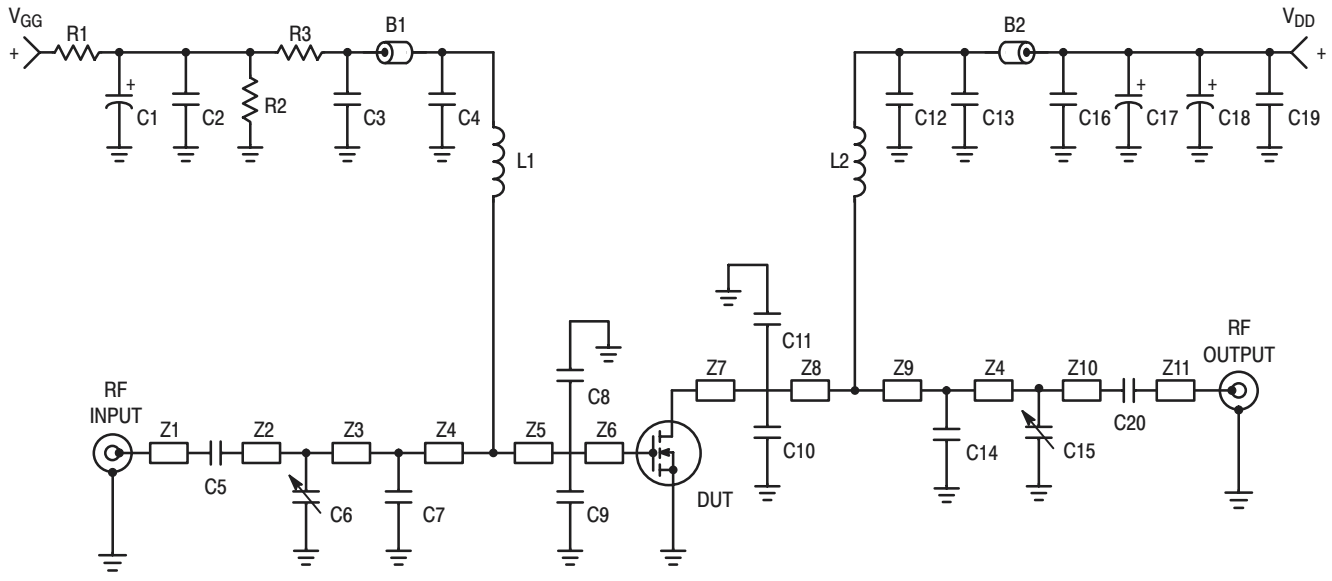

B1 – B2	Ferrite Bead, Fair Rite, 2743019447	L1, L2	5 Turns, #24 AWG, 0.059" OD
C1	10 μ F, 50 V, Electrolytic Capacitor, ECEV1HV100R Panasonic	R1	12 Ω , 1/4 Watt Carbon
C2, C16	0.10 μ F, B Case Chip Capacitors, CDR33BX104AKWS, Kemet	R2	4.7 M Ω , 1/4 Watt Carbon
C3	20000 pF, B Case Chip Capacitor, 200B203MCA50X, ATC	R3	16 k Ω , 1/4 Watt Carbon
C4, C13	100 pF, B Case Chip Capacitors, 100B101JCA500X, ATC	Z1, Z11	0.150" x 0.220" Microstrip
C5, C20	47 pF, B Case Chip Capacitors, 100B470JCA500X, ATC	Z2, Z10	0.410" x 0.220" Microstrip
C6, C15	0.8 – 8.0 pF, Variable Capacitors, Johanson Gigatrim	Z3	0.160" x 0.630" Microstrip
C7	4.7 pF, B Case Chip Capacitor, 100B4R7JCA500X, ATC	Z4	0.160" x 0.630" Microstrip
C8, C9	10 pF, B Case Chip Capacitors, 100B100JCA500X, ATC	Z5	0.098" x 0.630" Microstrip
C10, C11	16 pF, B Case Chip Capacitors, 100B160JCA500X, ATC	Z6	0.098" x 0.630" Microstrip
C12	43 pF, B Case Chip Capacitor, 100B430JCA500X, ATC	Z7	0.210" x 0.220" Microstrip
C14	7.5 pF, B Case Chip Capacitor, 100B7R5JCA500X, ATC	Z8	0.050" x 0.220" Microstrip
C17, C18, C19	10 μ F, 35 V, Electrolytic Capacitors, SMT, Kemet		

Figure 1. MRF187 Schematic

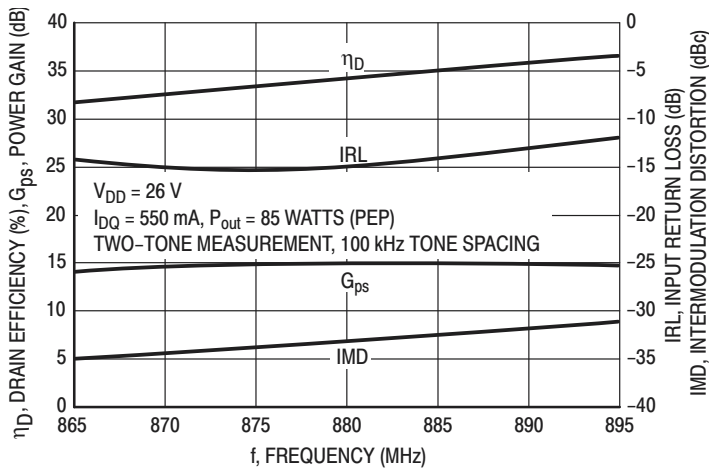
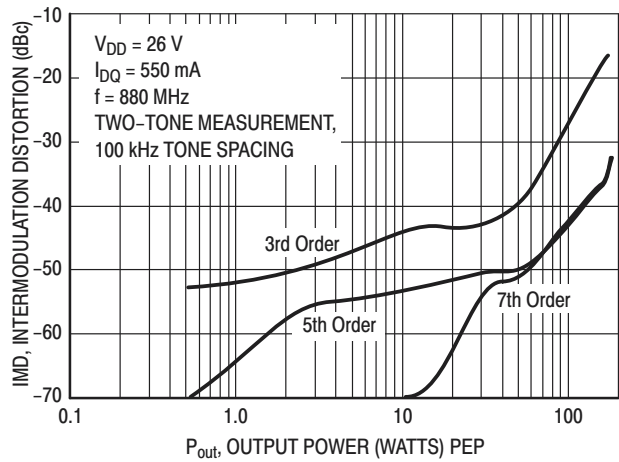
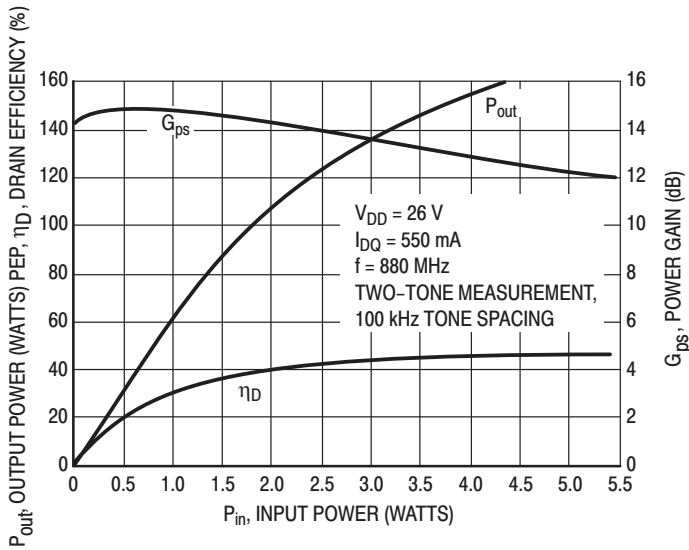
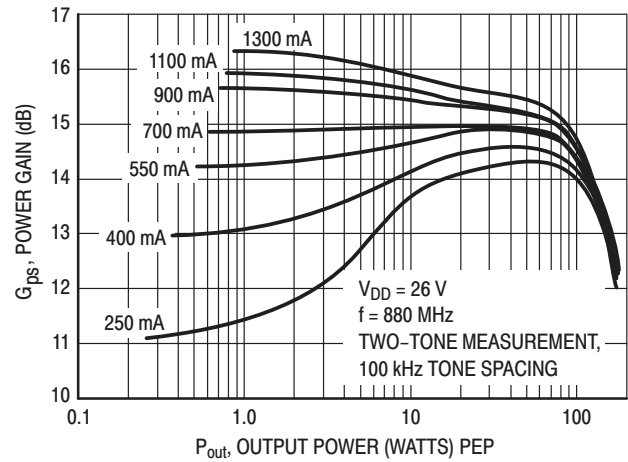
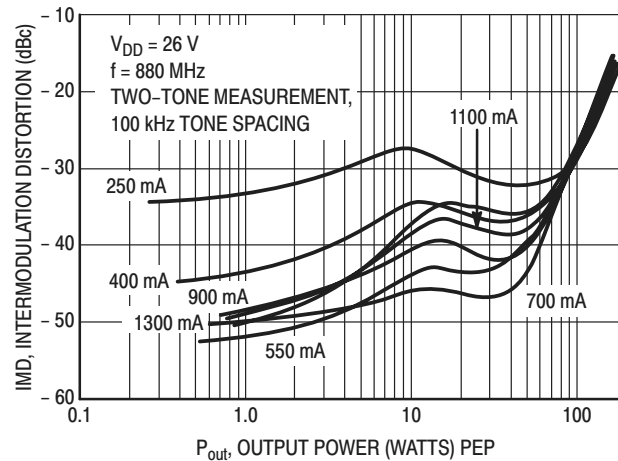
TYPICAL CHARACTERISTICS

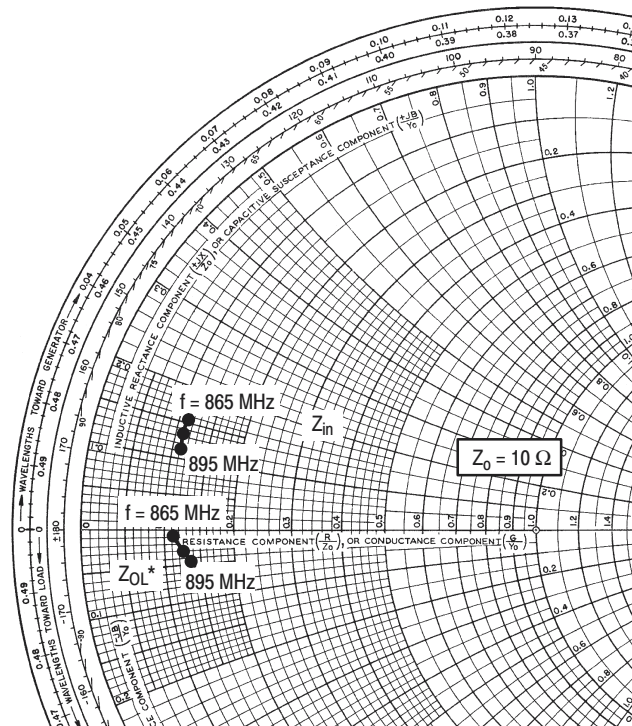
Figure 2. Class AB Broadband Circuit Performance

Figure 3. Intermodulation Distortion Products versus Output Power

Figure 4. Class AB Parameters versus Input Power

Figure 5. Power Gain versus Output Power

Figure 6. Intermodulation Distortion versus Output Power



$$V_{CC} = 26 \text{ V}, I_{DQ} = 550 \text{ mA}, P_{out} = 85 \text{ W PEP}$$

f MHz	Z_{in} Ω	Z_{OL}^* Ω
865	$1.04 + j1.51$	$1.13 - j0.091$
880	$1.03 + j1.39$	$1.20 - j0.176$
895	$1.03 + j1.29$	$1.28 - j0.242$

Z_{in} = Complex conjugate of source impedance.

Z_{OL}^* = Complex conjugate of the optimum load impedance at a given output power, voltage, IMD, bias current and frequency.

Note: Z_{OL}^* was chosen based on tradeoffs between gain, output power, drain efficiency and intermodulation distortion.

Figure 7. Series Equivalent Input and Output Impedance

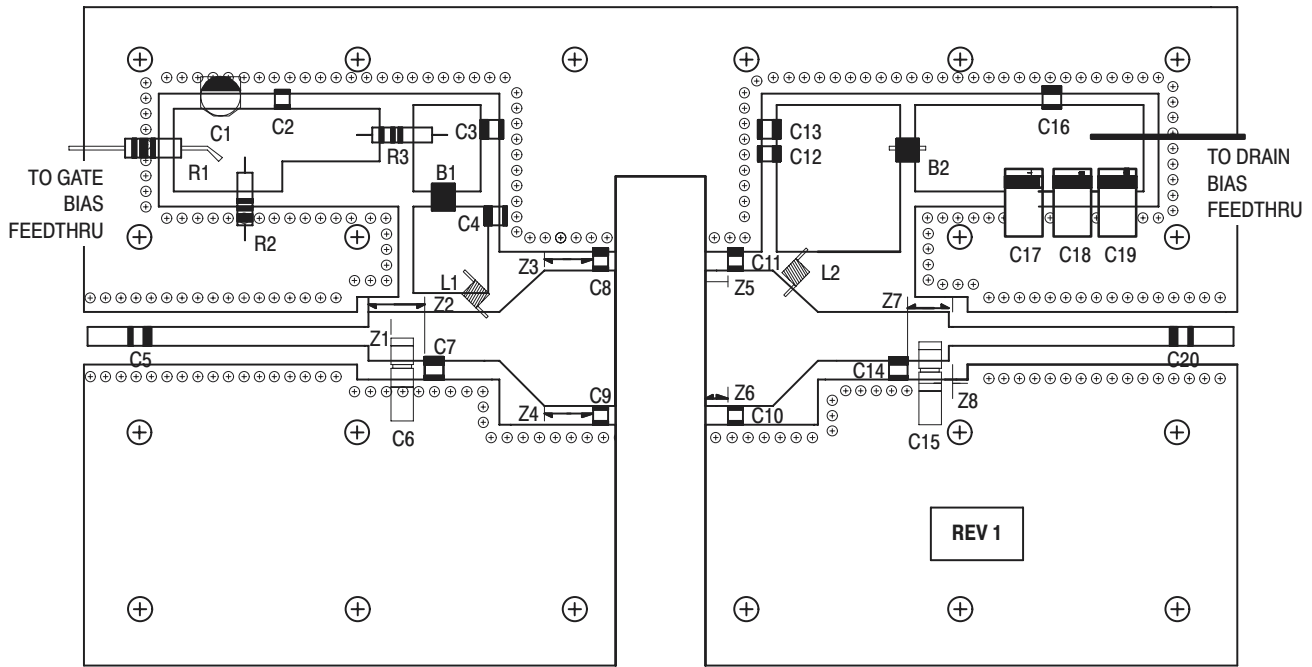

Figure 8. MRF187 Populated PC Board Layout Diagram

ARCHIVED 2005



PACKAGE DIMENSIONS

NOTES:
 1. DIMENSIONING AND TOLERANCING PER ANSI Y14.5M-1994.
 2. CONTROLLING DIMENSION: INCH.
 3. DELETED
 4. DIMENSION H IS MEASURED 0.030 (0.762) AWAY FROM PACKAGE BODY.

DIM	INCHES		MILLIMETERS	
	MIN	MAX	MIN	MAX
A	1.335	1.345	33.91	34.16
B	0.380	0.390	9.65	9.91
C	0.125	0.170	3.18	4.32
D	0.495	0.505	12.57	12.83
E	0.035	0.045	0.89	1.14
F	0.003	0.006	0.08	0.15
G	1.100 BSC		27.94 BSC	
H	0.057	0.067	1.45	1.70
K	0.170	0.210	4.32	5.33
M	0.774	0.786	19.66	19.96
N	0.772	0.788	19.60	20.00
Q	∅.118	∅.138	∅3.00	∅3.51
R	0.365	0.375	9.27	9.53
S	0.365	0.375	9.27	9.52
aaa	0.005 REF		0.127 REF	
bbb	0.010 REF		0.254 REF	
ccc	0.015 REF		0.381 REF	

STYLE 1:
 PIN 1. DRAIN
 2. GATE
 3. SOURCE

**CASE 465-06
 ISSUE F
 NI-780
 MRF187**

ARCHIVED 2005

NOTES:
 1. DIMENSIONING AND TOLERANCING PER ANSI Y14.5M-1994.
 2. CONTROLLING DIMENSION: INCH.
 3. DELETED
 4. DIMENSION H IS MEASURED 0.030 (0.762) AWAY FROM PACKAGE BODY.

DIM	INCHES		MILLIMETERS	
	MIN	MAX	MIN	MAX
A	0.805	0.815	20.45	20.70
B	0.380	0.390	9.65	9.91
C	0.125	0.170	3.18	4.32
D	0.495	0.505	12.57	12.83
E	0.035	0.045	0.89	1.14
F	0.003	0.006	0.08	0.15
H	0.057	0.067	1.45	1.70
K	0.170	0.210	4.32	5.33
M	0.774	0.786	19.61	20.02
N	0.772	0.788	19.61	20.02
R	0.365	0.375	9.27	9.53
S	0.365	0.375	9.27	9.52
U	---	0.040	---	1.02
Z	---	0.030	---	0.76
aaa	0.005 REF		0.127 REF	
bbb	0.010 REF		0.254 REF	
ccc	0.015 REF		0.381 REF	

STYLE 1:
 PIN 1. DRAIN
 2. GATE
 5. SOURCE

**CASE 465A-06
 ISSUE F
 NI-780S
 MRF187SR3**



ARCHIVED 2005

Motorola reserves the right to make changes without further notice to any products herein. Motorola makes no warranty, representation, or guarantee regarding the suitability of its products for any particular purpose, nor does Motorola assume any liability arising out of the application or use of any product or circuit, and specifically disclaims any and all liability, including without limitation consequential or incidental damages. "Typical" parameters can and do vary in different applications and actual performance may vary over time. All operating parameters, including "Typicals", must be validated for each customer application by customer's technical experts. Motorola does not convey any license under its patent rights nor the rights of others. Motorola products are not designed, intended, or authorized for use as components in systems intended for surgical implant into the body, or other applications intended to support or sustain life, or for any other application in which the failure of the Motorola product could create a situation where personal injury or death may occur. Should Buyer purchase or use Motorola products for any such unintended or unauthorized application, Buyer shall indemnify and hold Motorola and its officers, employees, subsidiaries, affiliates, and distributors harmless against all claims, costs, damages, and expenses, and reasonable attorney fees arising out of, directly or indirectly, any claim of personal injury or death associated with such unintended or unauthorized use, even if such claim alleges that Motorola was negligent regarding the design or manufacture of the part. Motorola and the Stylized M Logo are registered in the US Patent & Trademark Office. All other product or service names are the property of their respective owners. Motorola, Inc. is an Equal Opportunity/Affirmative Action Employer.

© Motorola, Inc. 2002.

How to reach us:

USA/EUROPE/Locations Not Listed: Motorola Literature Distribution; P.O. Box 5405, Denver, Colorado 80217. 1-303-675-2140 or 1-800-441-2447

JAPAN: Motorola Japan Ltd.; SPS, Technical Information Center, 3-20-1, Minami-Azabu. Minato-ku, Tokyo 106-8573 Japan. 81-3-3440-3569

ASIA/PACIFIC: Motorola Semiconductors H.K. Ltd.; Silicon Harbour Centre, 2 Dai King Street, Tai Po Industrial Estate, Tai Po, N.T. Hong Kong. 852-26668334

Technical Information Center: 1-800-521-6274

HOME PAGE: <http://www.motorola.com/semiconductors/>



MOTOROLA



MRF187/D

Archived 2005