



Advance Information

Dual-Band/Dual-Mode pHEMT GaAs IPA

The MRFIC1856 is designed for dual-band subscriber equipment applications at 3.6 V in the cellular (800 MHz) and PCS (1900 MHz) bands. The device incorporates two pHEMT GaAs amplifier chains in one package, allowing the most flexibility and highest performance while reducing board space. Target applications include dual-band/dual-mode handsets for TDMA/AMPS and PCS TDMA cellular phones.

- Designed to Operate in Frequency Ranges of:
 - 824 to 849 MHz TDMA/AMPS
 - 1850 to 1910 MHz PCS TDMA
- 3.6 V Operation
- 30 dBm Output Power PCS TDMA
- 31 dBm Output Power TDMA Cellular
- 31 dBm Output Power AMPS

MRFIC1856

DUAL-BAND/DUAL-MODE GaAs INTEGRATED POWER AMPLIFIER

SEMICONDUCTOR TECHNICAL DATA

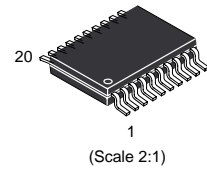

PLASTIC PACKAGE
CASE 948M
(TSSOP-20EP, Tape & Reel Only)

PIN CONNECTIONS

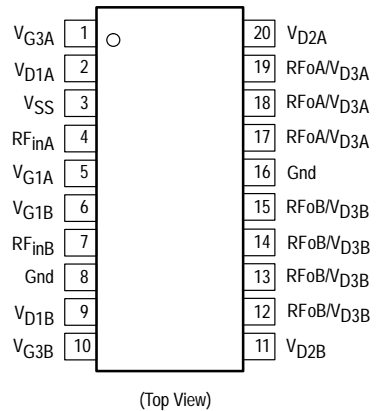

Simplified Block Diagram

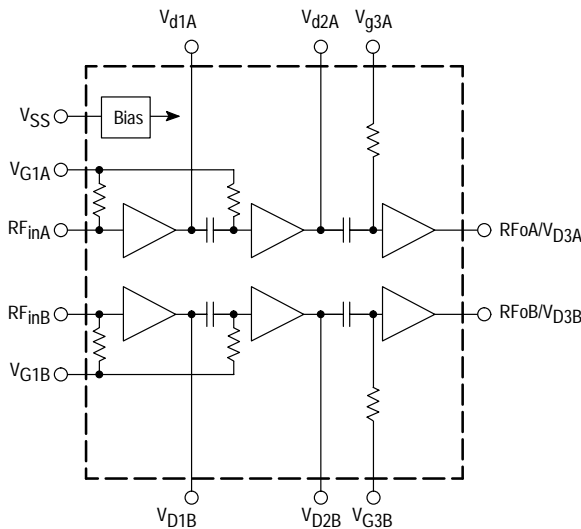

This device contains 8 active transistors.

ORDERING INFORMATION

Device	Operating Temp Range	Package
MRFIC1856R2	T _C = -35 to 85°C	TSSOP-20EP

Freescale Semiconductor, Inc. DEVICE ON LIFETIME BUY

LAST ORDER 19SEP02 LAST SHIP 19MAR03

MAXIMUM RATINGS

Rating	Symbol	Value	Unit
Supply Voltage	V _D	4.8	Vdc
RF Input Power	P _{in}	15	dBm
Gate Voltage	V _g	-6 to -0.3	Vdc
Storage Temperature Range	T _{stg}	-65 to 150	°C
Operating Case Temperature	T _C	-35 to 85	°C
Thermal Resistance, Junction to Case	R _{θJC}	15	°C/W

NOTES: 1. Maximum Ratings are those values beyond which damage to the device may occur. Functional operation should be restricted to the limits in the Electrical Characteristics tables.
 2. ESD (electrostatic discharge) immunity meets Human Body Model (HBM) ≤100 V and Machine Model (MM) <50 V. Additional ESD data available upon request.

RECOMMENDED OPERATING CONDITIONS

Characteristics	Symbol	Limit	Unit
Frequency Range – TDMA/AMPS	f _{RF}	824 to 849	MHz
Frequency Range – PCS TDMA	f _{RF}	1850 to 1910	MHz
Supply Voltage Range	V _{D1,2,3A} , V _{D1,2,3B}	3.0 to 4.8	Vdc
Negative Supply Voltage	V _G	-4.5 to -2.5	Vdc

ELECTRICAL CHARACTERISTICS (V_{D1,2,3A} = 3.6 V, T_A = 25°C, unless otherwise noted)

Characteristic	Symbol	Min	Typ	Max	Unit
----------------	--------	-----	-----	-----	------

TDMA CELLULAR PERFORMANCE (P_{out} = 31 dBm, f = 840 MHz)

Quiescent Supply Current	I _{DQ}	-	-	300	mA
Negative Supply Current	I _{SS}	-	-	3.0	mA
Efficiency	PAE	40	45	-	%
Gain	G _P	29	-	-	
Adj Channel Power (±30 kHz)	ACP	-	-	-29	dBc
Alt Channel Power (±60 kHz)	ALT	-	-	-48	dBc
Rx Band Noise (30 kHz BW)	-	-	-92	-	dBm
Harmonic Output Power	-	-	-	-	dBc
2f _o		-	-	-34	
3f _o		-	-	-40	
Spurious Output, 10:1 VSWR, all angles on output	-	-	-	-60	dBc

AMPS PERFORMANCE (P_{out} = 31 dBm, f = 840 MHz)

Quiescent Supply Current	I _{DQ}	-	-	300	mA
Negative Supply Current	I _{SS}	-	-	3.0	mA
Efficiency (P _{out} = 31 dBm)	PAE	-	48	-	%
Gain	G _P	30	-	-	
Harmonic Output Power	-	-	-	-	dBc
2f _o		-	-	-34	
3f _o		-	-	-40	
Rx Band Noise (30 kHz BW)	-	-	-92	-	dBm
Spurious Output, 10:1 VSWR, all angles on output	-	-	-	-60	dBc

PCS TDMA PERFORMANCE (P_{out} = 30 dBm, f = 1.88 GHz)

Quiescent Supply Current	-	-	-	300	mA
Negative Supply Current	-	-	-	3.0	mA
Efficiency	-	30	35	-	%
Gain	-	28	-	-	

Freescale Semiconductor, Inc. DEVICE ON LIFETIME BUY

LAST ORDER 19SEP02 LAST SHIP 19MAR03

ELECTRICAL CHARACTERISTICS (continued) ($V_{D1,2,3A} = 3.6\text{ V}$, $T_A = 25^\circ\text{C}$, unless otherwise noted)

Characteristic	Symbol	Min	Typ	Max	Unit
PCS TDMA PERFORMANCE (continued) ($P_{\text{out}} = 30\text{ dBm}$, $f = 1.88\text{ GHz}$)					
Adj Channel Power ($\pm 30\text{ kHz}$)	-	-	-	-29	dBc
Alt Channel Power ($\pm 60\text{ kHz}$)	-	-	-	-48	dBc
Rx Band Noise (30 kHz BW)	-	-	-94	-	dBm
Harmonic Output Power	-	-	-	-	dBc
$2f_o$	-	-	-	-40	
$3f_o$	-	-	-	-40	
Spurious Output, 10:1 VSWR, all angles on output	-	-	-	-60	dBc

Figure 1. 3.6 V Applications Circuit

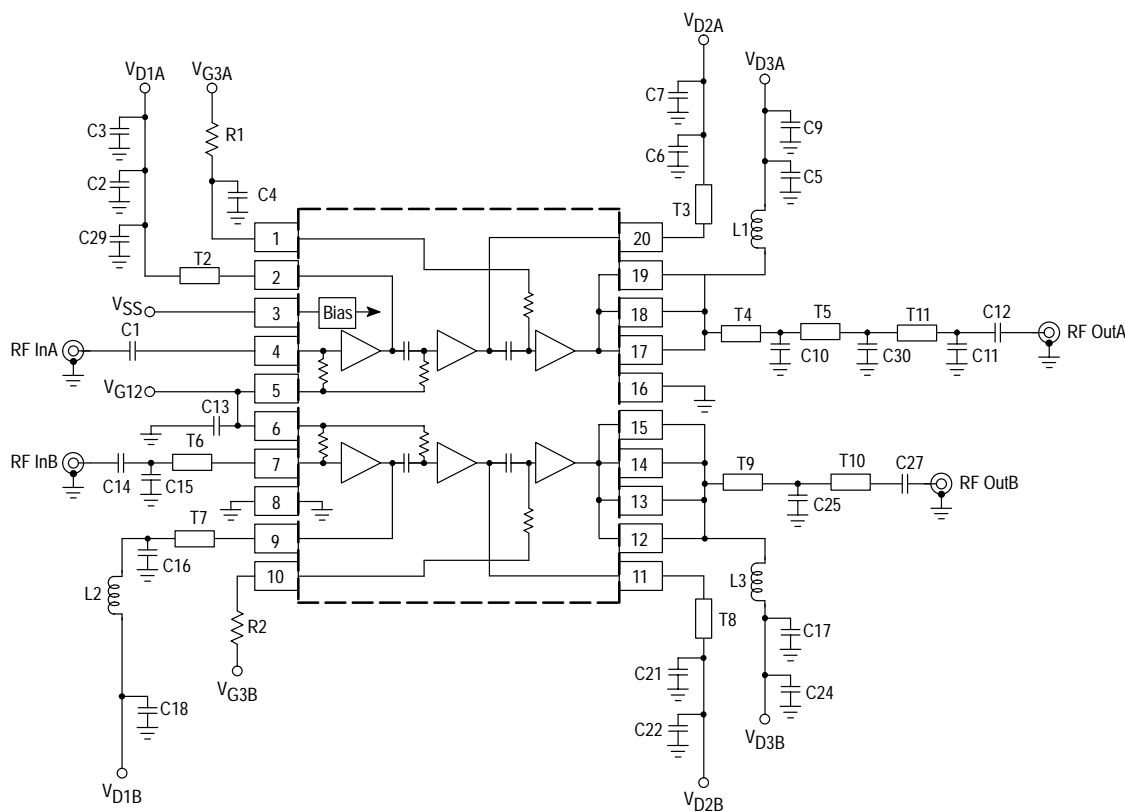

C1,C2,C5,C12,C17, 100 pF	C16 6.2 pF	T2 50 Ω , Microstrip, L = 128 mils
C28 3.9 nF	C25 4.7 pF	T3 50 Ω , Microstrip, L = 50 mils
C3,C4,C6,C13,C21 1000 pF	C27 10 pF	T4 50 Ω , Microstrip, L = 60 mils
C7,C18 10 μF	C29 3.9 pF	T5 90 Ω , Microstrip, L = 88 mils
C9,C22,C24 20 μF	L1,L2,L3 15 nH	T6 90 Ω , Microstrip, L = 600 mils
C10 12 pF	R1 50 Ω	T7 63 Ω , Microstrip, L = 133 mils
C11 5.1 pF	R2 100 Ω	T8 50 Ω , Microstrip, L = 133 mils
C14 22 pF		T9 50 Ω , Microstrip, L = 10 mils
C15,C30 1.3 pF		T10 50 Ω , Microstrip, L = 330 mils
		T11 50 Ω , Microstrip, L = 145 mils

NOTE: C29 added for 2nd harm trap.

Freescale Semiconductor, Inc. DEVICE ON LIFETIME BUY

LAST ORDER 19SEP02 LAST SHIP 19MAR03



Figure 2. 4.8 V Applications Circuit

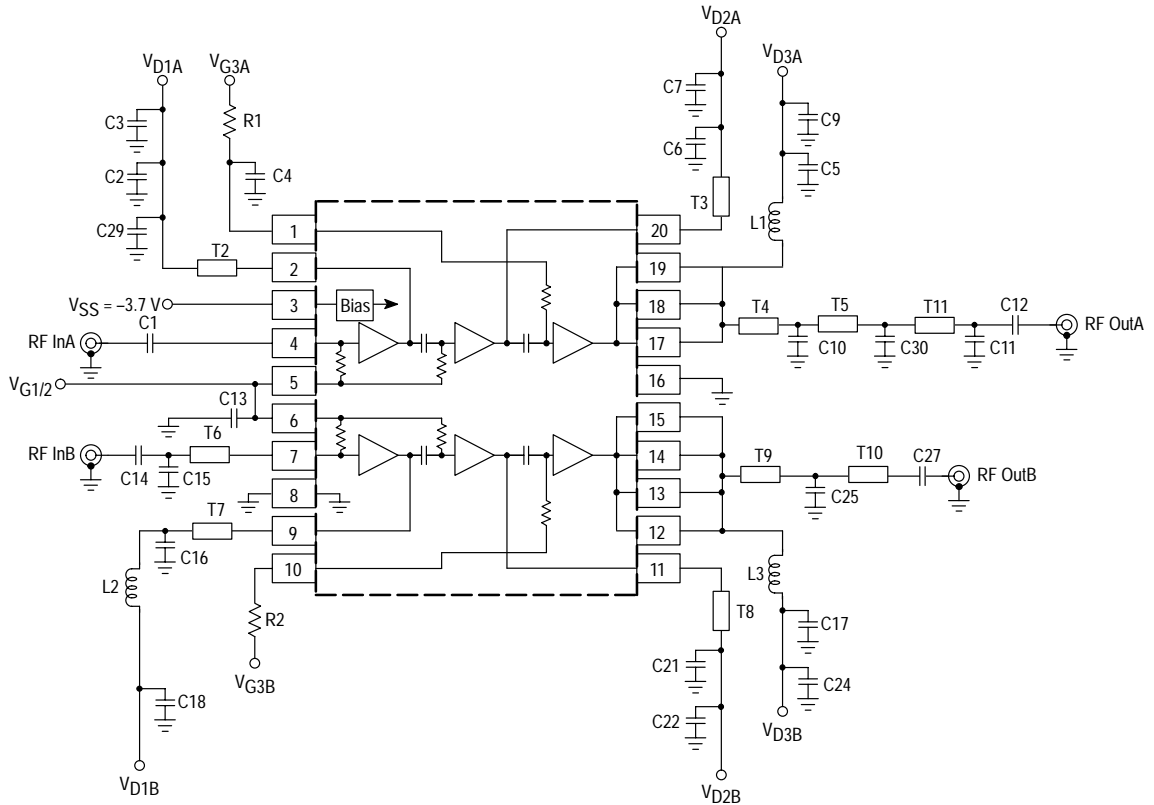

C1,C2,C5,C12,C17, 100 pF	C16	6.8 pF	T2	50 Ω, Microstrip, L = 128 mils
C28 3.9 nF	C25	4.3 pF	T3	50 Ω, Microstrip, L = 50 mils
C3,C4,C6,C13,C21 1000 pF	C27	10 pF	T4	50 Ω, Microstrip, L = 60 mils
C7,C18 10 μF	C29	3.9 pF	T5	90 Ω, Microstrip, L = 88 mils
C9,C22,C24 20 μF	L1,L2,L3	15 nH	T6	90 Ω, Microstrip, L = 600 mils
C10 12 pF	R1	50 Ω	T7	63 Ω, Microstrip, L = 133 mils
C11 5.1 pF	R2	100 Ω	T8	50 Ω, Microstrip, L = 133 mils
C14 22 pF			T9	50 Ω, Microstrip, L = 10 mils
C15,C30 1.3 pF			T10	50 Ω, Microstrip, L = 330 mils
			T11	50 Ω, Microstrip, L = 145 mils

Freescale Semiconductor, Inc.
DEVICE ON LIFETIME BUY

LAST ORDER 19SEP02 LAST SHIP 19MAR03



TDMA PERFORMANCE

Figure 3. Gain versus Frequency

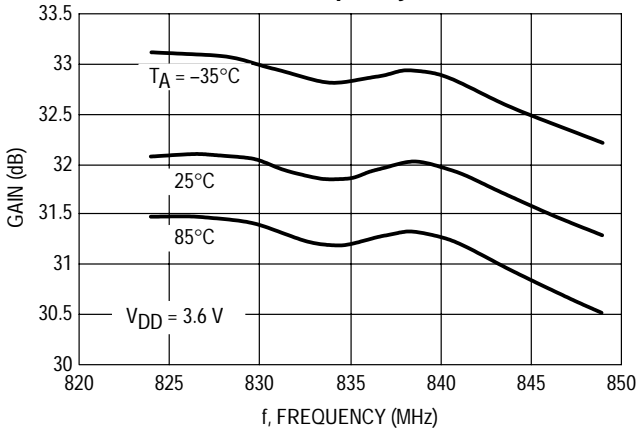

Figure 4. Gain versus Frequency

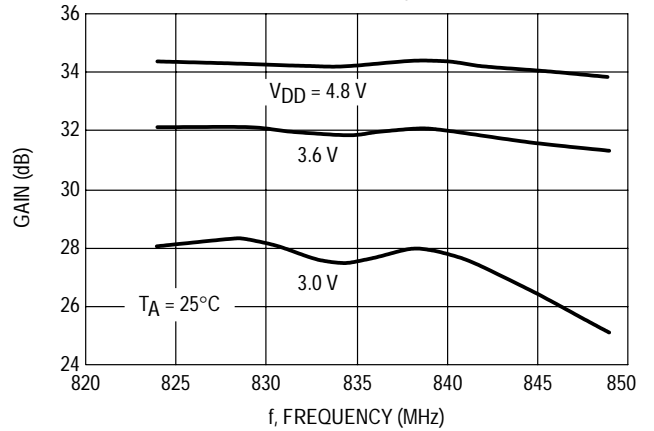

Figure 5. Output Power versus Input Power

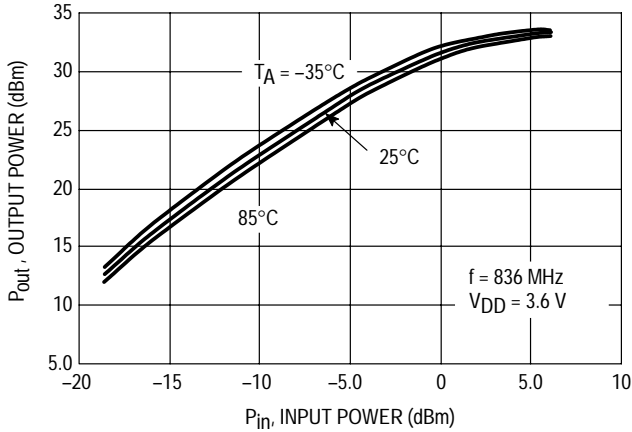

Figure 6. Output Power versus Input Power

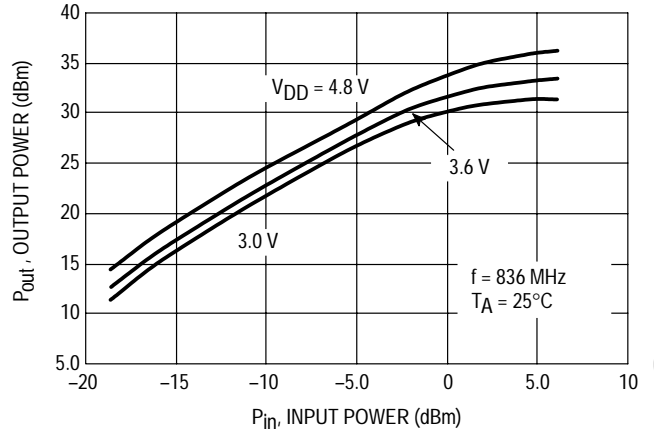

Figure 7. Adjacent Channel Power versus Output Power

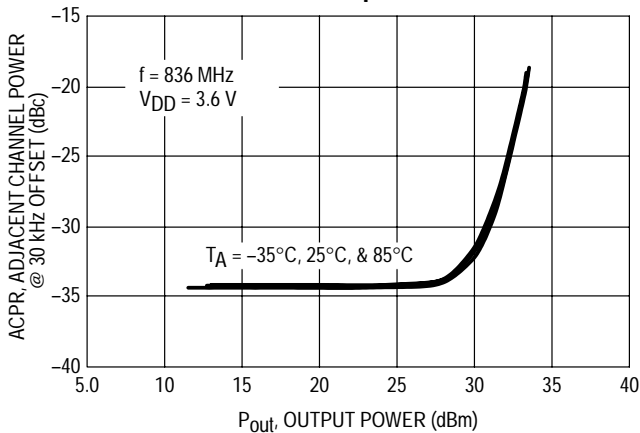
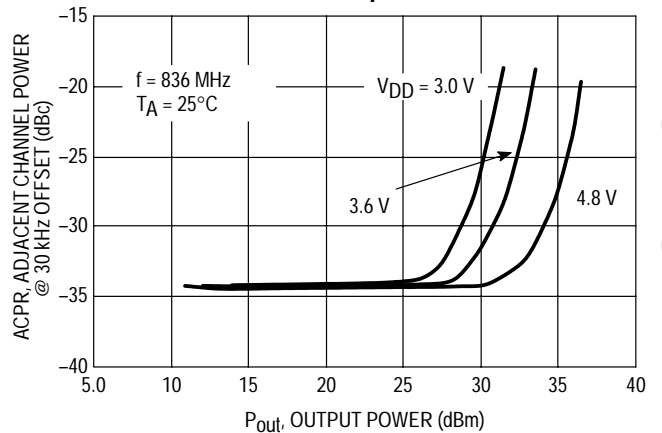

Figure 8. Adjacent Channel Power versus Output Power



Freescale Semiconductor, Inc. DEVICE ON LIFETIME BUY

LAST ORDER 19SEP02 LAST SHIP 19MAR03



TDMA PERFORMANCE

Figure 9. Alternate Channel Power versus Output Power

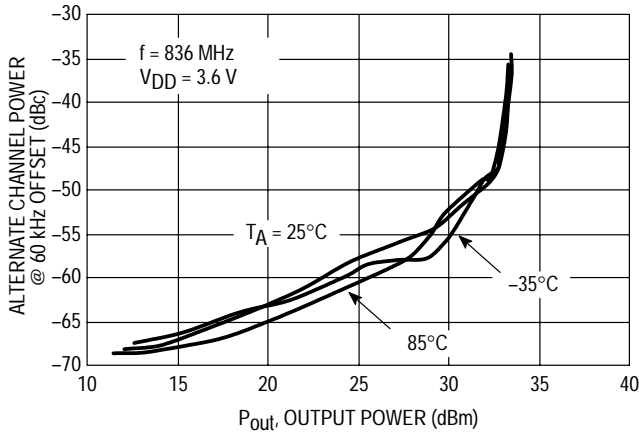

Figure 10. Alternate Channel Power versus Output Power

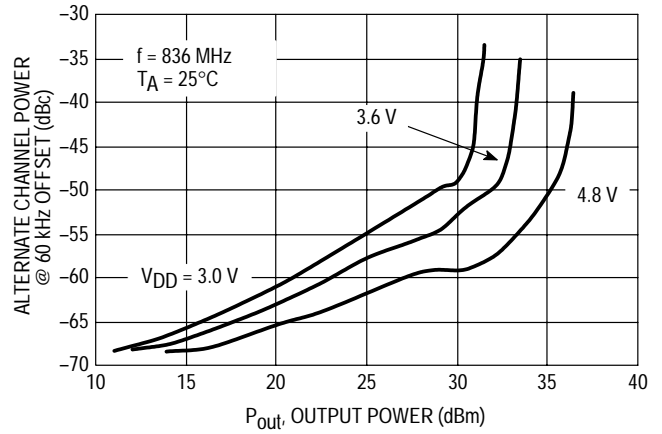

Figure 11. Gain versus Frequency

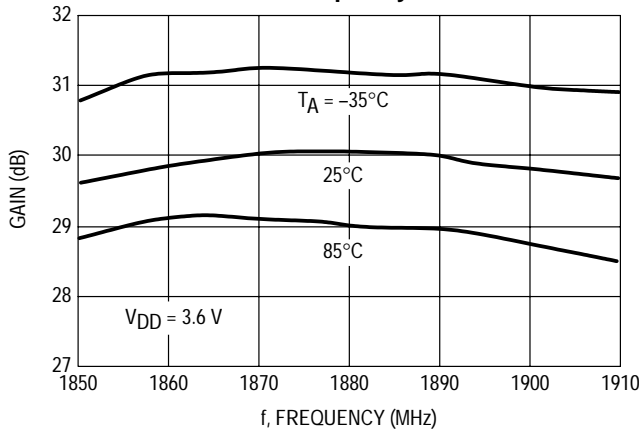

Figure 12. Gain versus Frequency

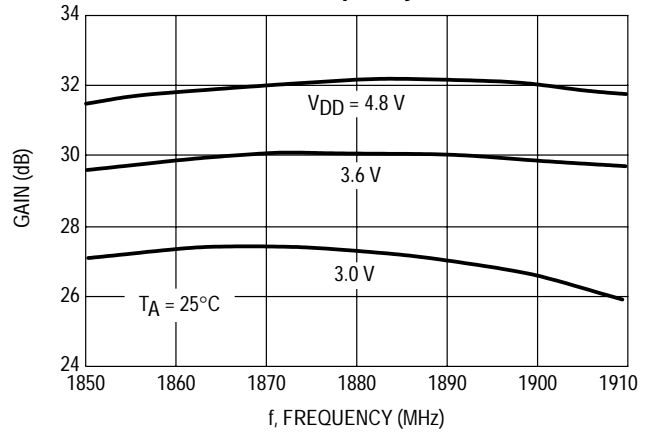

Figure 13. Output Power versus Input Power

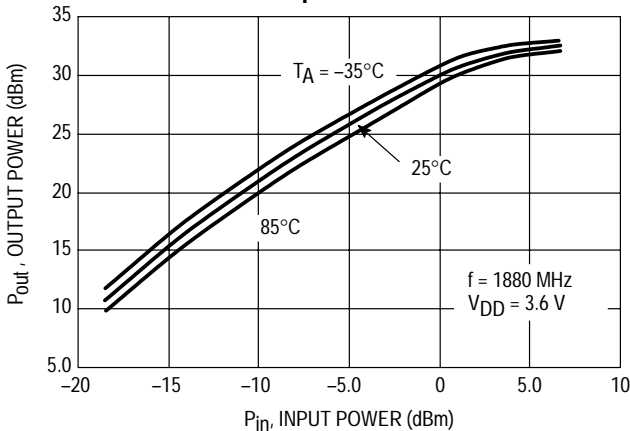
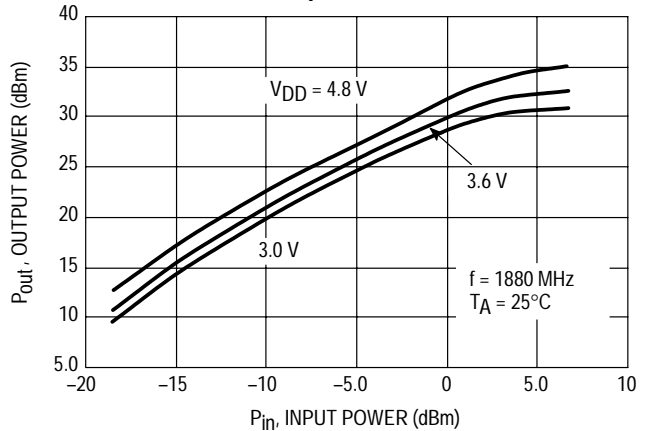

Figure 14. Output Power versus Input Power



Freescale Semiconductor, Inc. DEVICE ON LIFETIME BUY

LAST ORDER 19SEP02 LAST SHIP 19MAR03



TDMA PERFORMANCE

Figure 15. Adjacent Channel Power versus Output Power

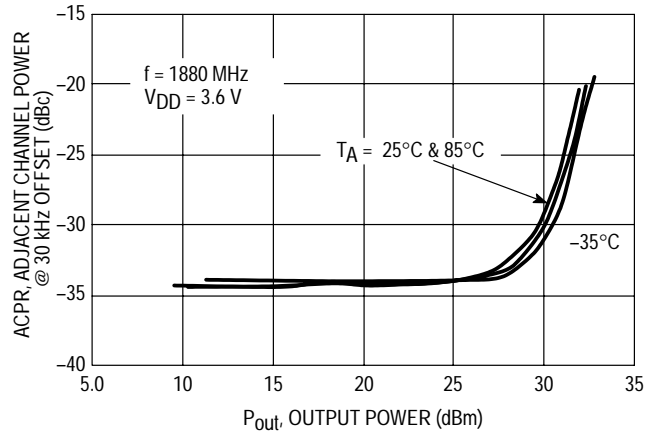

Figure 16. Adjacent Channel Power versus Output Power

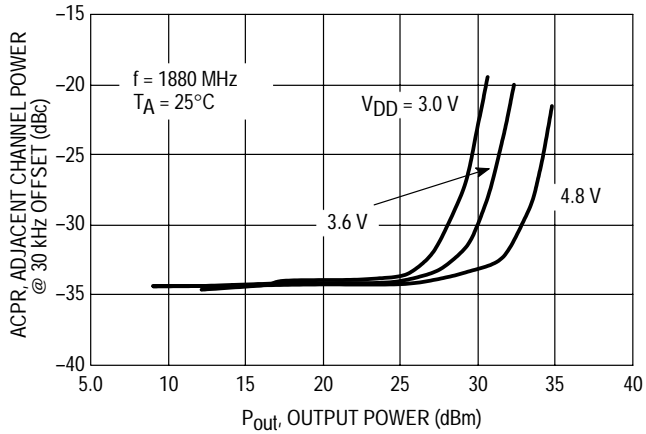

Figure 17. Alternate Channel Power versus Output Power

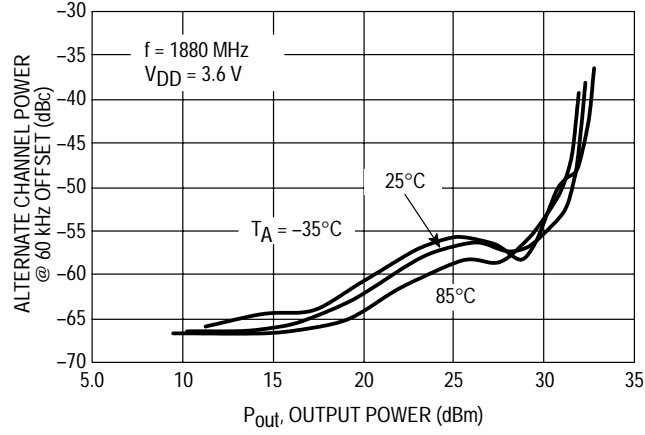
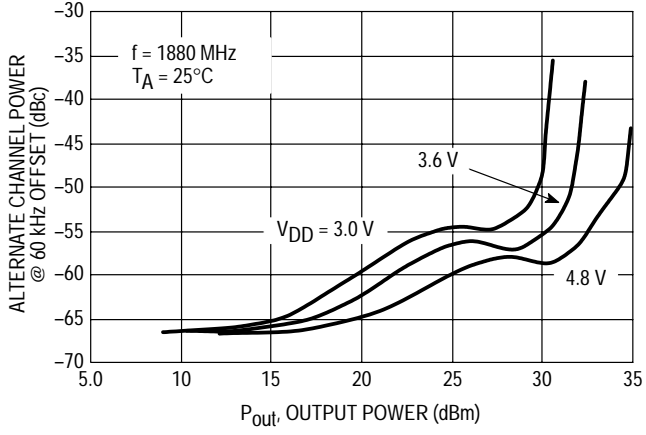

Figure 18. Alternate Channel Power versus Output Power



Freescale Semiconductor, Inc. DEVICE ON LIFETIME BUY

LAST ORDER 19SEP02 LAST SHIP 19MAR03

OUTLINE DIMENSIONS

PLASTIC PACKAGE
CASE 948M-01
(TSSOP-20EP)
ISSUE O

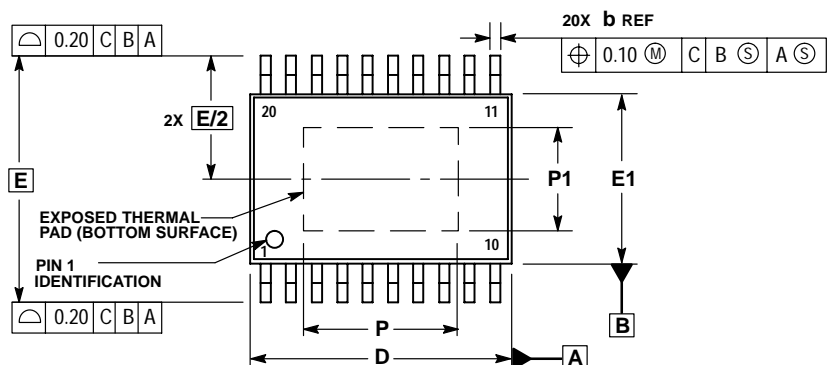

- NOTES:
- 1 DIMENSIONS ARE IN MILLIMETERS.
 - 2 INTERPRET DIMENSIONS AND TOLERANCES PER ASME Y14.5M, 1994.
 - 3 DIMENSION D DOES NOT INCLUDE MOLD FLASH, PROTRUSIONS OR GATE BURRS. MOLD FLASH OR GATE BURRS SHALL NOT EXCEED 0.15 PER SIDE.
 - 4 DIMENSION E1 DOES NOT INCLUDE INTERLEAD FLASH OR PROTRUSION. INTERLEAD FLASH OR PROTRUSION SHALL NOT EXCEED 0.25 PER SIDE.
 - 5 DIMENSION b DOES NOT INCLUDE DAMBAR PROTRUSION. ALLOWABLE DAMBAR PROTRUSION SHALL BE 0.08 TOTAL IN EXCESS OF THE b DIMENSION AT MAXIMUM MATERIAL CONDITION.
 - 6 TERMINAL NUMBERS ARE SHOWN FOR REFERENCE ONLY.
 - 7 DIMENSIONS D AND E1 ARE TO BE DETERMINED AT DATUM PLANE H.

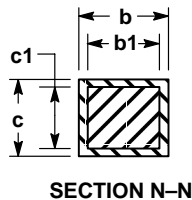
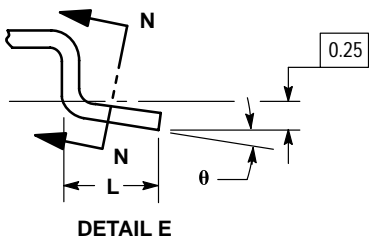
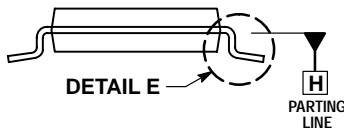
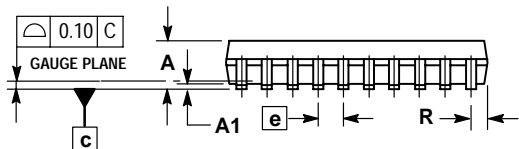

DIM	MILLIMETERS	
	MIN	MAX
A	---	1.20
A1	0.00	0.10
b	0.19	0.30
b1	0.19	0.25
c	0.09	0.20
c1	0.09	0.16
D	6.40	6.60
E	6.40 BSC	
E1	4.30	4.50
e	0.65 BSC	
L	0.50	0.75
P	---	4.80
P1	---	3.00
R	0.27	0.37
theta	0° 8°	

Freescale Semiconductor, Inc. DEVICE ON LIFETIME BUY

LAST ORDER 19SEP02 LAST SHIP 19MAR03

Motorola reserves the right to make changes without further notice to any products herein. Motorola makes no warranty, representation or guarantee regarding the suitability of its products for any particular purpose, nor does Motorola assume any liability arising out of the application or use of any product or circuit, and specifically disclaims any and all liability, including without limitation consequential or incidental damages. "Typical" parameters which may be provided in Motorola data sheets and/or specifications can and do vary in different applications and actual performance may vary over time. All operating parameters, including "Typicals" must be validated for each customer application by customer's technical experts. Motorola does not convey any license under its patent rights nor the rights of others. Motorola products are not designed, intended, or authorized for use as components in systems intended for surgical implant into the body, or other applications intended to support or sustain life, or for any other application in which the failure of the Motorola product could create a situation where personal injury or death may occur. Should Buyer purchase or use Motorola products for any such unintended or unauthorized application, Buyer shall indemnify and hold Motorola and its officers, employees, subsidiaries, affiliates, and distributors harmless against all claims, costs, damages, and expenses, and reasonable attorney fees arising out of, directly or indirectly, any claim of personal injury or death associated with such unintended or unauthorized use, even if such claim alleges that Motorola was negligent regarding the design or manufacture of the part. Motorola and are registered trademarks of Motorola, Inc. Motorola, Inc. is an Equal Opportunity/Affirmative Action Employer.

How to reach us:

USA/EUROPE/Locations Not Listed: Motorola Literature Distribution; P.O. Box 5405, Denver, Colorado 80217. 1-303-675-2140 or 1-800-441-2447

JAPAN: Motorola Japan Ltd.; SPS, Technical Information Center, 3-20-1, Minami-Azabu, Minato-ku, Tokyo, 106-8573 Japan. 81-3-3440-3569

Customer Focus Center: 1-800-521-6274

ASIA/PACIFIC: Motorola Semiconductors H.K. Ltd.; Silicon Harbour Centre, 2, Dai King Street, Tai Po Industrial Estate, Tai Po, N.T., Hong Kong. 852-26668334

HOME PAGE: <http://www.motorola.com/semiconductors>



For More Information On This Product, Go to: www.freescale.com

MRFIC1856/D