

High Speed, High Gain Bipolar NPN Power Transistor with Integrated Collector-Emitter Diode and Built-in Efficient Antisaturation Network

The BUD44D2 is state-of-art High Speed High gain BIPolar transistor (H2BIP). High dynamic characteristics and lot to lot minimum spread (± 150 ns on storage time) make it ideally suitable for light ballast applications. Therefore, there is no need to guarantee an h_{FE} window.

Main features:

- Low Base Drive Requirement
- High Peak DC Current Gain (55 Typical) @ $I_C = 100$ mA
- **Extremely Low Storage Time Min/Max Guarantees Due to the H2BIP Structure which Minimizes the Spread**
- Integrated Collector-Emitter Free Wheeling Diode
- Fully Characterized and Guaranteed Dynamic $V_{CE(sat)}$
- Six Sigma Process Providing Tight and Reproducible Parameter Spreads
- It's characteristics make it also suitable for PFC application.

MAXIMUM RATINGS

Rating	Symbol	Value	Unit
Collector-Emitter Sustaining Voltage	V_{CEO}	400	Vdc
Collector-Base Breakdown Voltage	V_{CBO}	700	Vdc
Collector-Emitter Breakdown Voltage	V_{CES}	700	Vdc
Emitter-Base Voltage	V_{EBO}	12	Vdc
Collector Current — Continuous	I_C	2	Adc
— Peak (1)	I_{CM}	5	
Base Current — Continuous	I_B	1	Adc
— Peak (1)	I_{BM}	2	
*Total Device Dissipation @ $T_C = 25^\circ\text{C}$	P_D	25	Watt
*Derate above 25°C		0.2	W/ $^\circ\text{C}$
Operating and Storage Temperature	T_J, T_{stg}	-65 to 150	$^\circ\text{C}$

THERMAL CHARACTERISTICS

Thermal Resistance			$^\circ\text{C/W}$
— Junction to Case	$R_{\theta JC}$	5	
— Junction to Ambient	$R_{\theta JA}$	71.4	
Maximum Lead Temperature for Soldering Purposes: 1/8" from case for 5 seconds	T_L	260	$^\circ\text{C}$

(1) Pulse Test: Pulse Width = 5 ms, Duty Cycle $\leq 10\%$.

BUD44D2

POWER TRANSISTORS
2 AMPERES
700 VOLTS
25 WATTS

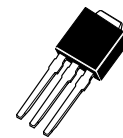
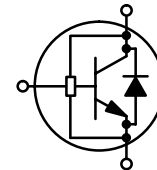

CASE 369-07



CASE 369A-13

MINIMUM PAD SIZES RECOMMENDED FOR SURFACE MOUNTED APPLICATIONS

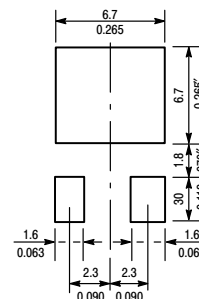

BUD44D2

ELECTRICAL CHARACTERISTICS ($T_C = 25^\circ\text{C}$ unless otherwise noted)

Characteristic	Symbol	Min	Typ	Max	Unit
OFF CHARACTERISTICS					
Collector–Emitter Sustaining Voltage ($I_C = 100\text{ mA}$, $L = 25\text{ mH}$)	$V_{CE(sus)}$	400	470		Vdc
Collector–Base Breakdown Voltage ($I_{CBO} = 1\text{ mA}$)	V_{CBO}	700	920		Vdc
Emitter–Base Breakdown Voltage ($I_{EBO} = 1\text{ mA}$)	V_{EBO}	12	14.5		Vdc
Collector Cutoff Current ($V_{CE} = \text{Rated } V_{CEO}$, $I_B = 0$)	@ $T_C = 25^\circ\text{C}$ @ $T_C = 125^\circ\text{C}$ I_{CEO}			50 500	μAdc
Collector Cutoff Current ($V_{CE} = \text{Rated } V_{CES}$, $V_{EB} = 0$) ($V_{CE} = 500\text{ V}$, $V_{EB} = 0$)	@ $T_C = 25^\circ\text{C}$ @ $T_C = 125^\circ\text{C}$ @ $T_C = 125^\circ\text{C}$ I_{CES}			50 500 100	μAdc
Emitter–Cutoff Current ($V_{EB} = 10\text{ Vdc}$, $I_C = 0$)	I_{EBO}			100	μAdc

ON CHARACTERISTICS

Base–Emitter Saturation Voltage ($I_C = 0.4\text{ Adc}$, $I_B = 40\text{ mAdc}$) ($I_C = 1\text{ Adc}$, $I_B = 0.2\text{ Adc}$)	@ $T_C = 25^\circ\text{C}$ @ $T_C = 125^\circ\text{C}$	$V_{BE(sat)}$		0.78 0.65	0.9 0.8	Vdc
	@ $T_C = 25^\circ\text{C}$ @ $T_C = 125^\circ\text{C}$			0.87 0.76	1 0.9	
Collector–Emitter Saturation Voltage ($I_C = 0.4\text{ Adc}$, $I_B = 20\text{ mAdc}$) ($I_C = 0.4\text{ Adc}$, $I_B = 40\text{ mAdc}$) ($I_C = 1\text{ Adc}$, $I_B = 0.2\text{ Adc}$)	@ $T_C = 25^\circ\text{C}$ @ $T_C = 125^\circ\text{C}$	$V_{CE(sat)}$		0.45 0.67	0.65 1	Vdc
	@ $T_C = 25^\circ\text{C}$ @ $T_C = 125^\circ\text{C}$			0.25 0.27	0.4 0.5	
	@ $T_C = 25^\circ\text{C}$ @ $T_C = 125^\circ\text{C}$			0.28 0.35	0.5 0.6	
DC Current Gain ($I_C = 0.4\text{ Adc}$, $V_{CE} = 1\text{ Vdc}$) ($I_C = 1\text{ Adc}$, $V_{CE} = 1\text{ Vdc}$) ($I_C = 2\text{ Adc}$, $V_{CE} = 5\text{ Vdc}$)	@ $T_C = 25^\circ\text{C}$ @ $T_C = 125^\circ\text{C}$	h_{FE}	20 18	32 26		—
	@ $T_C = 25^\circ\text{C}$ @ $T_C = 125^\circ\text{C}$		10 7	14 9.5		
	@ $T_C = 25^\circ\text{C}$		8	11		

DIODE CHARACTERISTICS

Forward Diode Voltage ($I_{EC} = 0.2\text{ Adc}$) ($I_{EC} = 0.2\text{ Adc}$) ($I_{EC} = 0.4\text{ Adc}$) ($I_{EC} = 1\text{ Adc}$)	@ $T_C = 25^\circ\text{C}$	V_{EC}		0.8	1	V
	@ $T_C = 125^\circ\text{C}$			0.6		
	@ $T_C = 25^\circ\text{C}$			0.9	1.2	
	@ $T_C = 25^\circ\text{C}$			1.1	1.5	
Forward Recovery Time (see Figure 22 bis) ($I_F = 0.2\text{ Adc}$, $di/dt = 10\text{ A}/\mu\text{s}$) ($I_F = 0.4\text{ Adc}$, $di/dt = 10\text{ A}/\mu\text{s}$) ($I_F = 1\text{ Adc}$, $di/dt = 10\text{ A}/\mu\text{s}$)	@ $T_C = 25^\circ\text{C}$	T_{fr}		415		ns
	@ $T_C = 25^\circ\text{C}$			390		
	@ $T_C = 25^\circ\text{C}$			340		

BUD44D2

ELECTRICAL CHARACTERISTICS ($T_C = 25^\circ\text{C}$ unless otherwise noted)

Characteristic	Symbol	Min	Typ	Max	Unit
----------------	--------	-----	-----	-----	------

DYNAMIC SATURATION VOLTAGE

Dynamic Saturation Voltage: Determined 1 μs and 3 μs respectively after rising I_{B1} reaches 90% of final I_{B1}	$I_C = 0.4\text{ A}$ $I_{B1} = 40\text{ mA}$ $V_{CC} = 300\text{ V}$	@ 1 μs	@ $T_C = 25^\circ\text{C}$ @ $T_C = 125^\circ\text{C}$	$V_{CE(dsat)}$		3.3 6.8		V
		@ 3 μs	@ $T_C = 25^\circ\text{C}$ @ $T_C = 125^\circ\text{C}$			0.5 1.3		
	$I_C = 1\text{ A}$ $I_{B1} = 0.2\text{ A}$ $V_{CC} = 300\text{ V}$	@ 1 μs	@ $T_C = 25^\circ\text{C}$ @ $T_C = 125^\circ\text{C}$			4.4 12.8		
		@ 3 μs	@ $T_C = 25^\circ\text{C}$ @ $T_C = 125^\circ\text{C}$			0.5 1.8		

DYNAMIC CHARACTERISTICS

Current Gain Bandwidth ($I_C = 0.5\text{ Adc}$, $V_{CE} = 10\text{ Vdc}$, $f = 1\text{ MHz}$)	f_T		13		MHz
Output Capacitance ($V_{CB} = 10\text{ Vdc}$, $I_E = 0$, $f = 1\text{ MHz}$)	C_{ob}		50	75	pF
Input Capacitance ($V_{EB} = 8\text{ Vdc}$)	C_{ib}		240	500	pF

SWITCHING CHARACTERISTICS: Resistive Load ($D.C. \leq 10\%$, Pulse Width = 40 μs)

Turn-on Time	$I_C = 1\text{ Adc}$, $I_{B1} = 0.2\text{ Adc}$ $I_{B2} = 0.5\text{ Adc}$ $V_{CC} = 300\text{ Vdc}$	@ $T_C = 25^\circ\text{C}$ @ $T_C = 125^\circ\text{C}$	t_{on}		90 105	150	ns
Turn-off Time		@ $T_C = 25^\circ\text{C}$ @ $T_C = 125^\circ\text{C}$	t_{off}		1.1 1.5	1.25	μs
Turn-on Time	$I_C = 0.5\text{ Adc}$, $I_{B1} = 50\text{ mAdc}$ $I_{B2} = 250\text{ mAdc}$ $V_{CC} = 300\text{ Vdc}$	@ $T_C = 25^\circ\text{C}$ @ $T_C = 125^\circ\text{C}$	t_{on}	400	600	600	ns
Turn-off Time		@ $T_C = 25^\circ\text{C}$ @ $T_C = 125^\circ\text{C}$	t_{off}	750	1300	1000	ns

BUD44D2

Characteristic	Symbol	Min	Typ	Max	Unit
SWITCHING CHARACTERISTICS: Inductive Load ($V_{clamp} = 300\text{ V}$, $V_{CC} = 15\text{ V}$, $L = 200\text{ }\mu\text{H}$)					
Fall Time	$I_C = 0.4\text{ Adc}$ $I_{B1} = 40\text{ mAdc}$ $I_{B2} = 0.2\text{ Adc}$	@ $T_C = 25^\circ\text{C}$ @ $T_C = 125^\circ\text{C}$	t_f	110 105	150 ns
Storage Time		@ $T_C = 25^\circ\text{C}$ @ $T_C = 125^\circ\text{C}$	t_s	0.55 0.7	0.75 μs
Crossover Time		@ $T_C = 25^\circ\text{C}$ @ $T_C = 125^\circ\text{C}$	t_c	85 80	150 ns
Fall Time	$I_C = 1\text{ Adc}$ $I_{B1} = 0.2\text{ Adc}$ $I_{B2} = 0.5\text{ Adc}$	@ $T_C = 25^\circ\text{C}$ @ $T_C = 125^\circ\text{C}$	t_f	100 90	150 ns
Storage Time		@ $T_C = 25^\circ\text{C}$ @ $T_C = 125^\circ\text{C}$	t_s	1.05 1.45	1.5 μs
Crossover Time		@ $T_C = 25^\circ\text{C}$ @ $T_C = 125^\circ\text{C}$	t_c	100 100	175 ns
Fall Time	$I_C = 0.8\text{ Adc}$ $I_{B1} = 160\text{ mAdc}$ $I_{B2} = 160\text{ mAdc}$	@ $T_C = 25^\circ\text{C}$ @ $T_C = 125^\circ\text{C}$	t_f	110 180	150 ns
Storage Time		@ $T_C = 25^\circ\text{C}$ @ $T_C = 125^\circ\text{C}$	t_s	2.05 2.8	2.35 μs
Crossover Time		@ $T_C = 25^\circ\text{C}$ @ $T_C = 125^\circ\text{C}$	t_c	180 400	300 ns
Fall Time	$I_C = 0.4\text{ Adc}$ $I_{B1} = 40\text{ mAdc}$ $I_{B2} = 40\text{ mAdc}$	@ $T_C = 25^\circ\text{C}$ @ $T_C = 125^\circ\text{C}$	t_f	150 175	225 ns
Storage Time		@ $T_C = 25^\circ\text{C}$ @ $T_C = 125^\circ\text{C}$	t_s	1.65 2.2	1.95 μs
Crossover Time		@ $T_C = 25^\circ\text{C}$ @ $T_C = 125^\circ\text{C}$	t_c	150 330	250 ns

TYPICAL STATIC CHARACTERISTICS

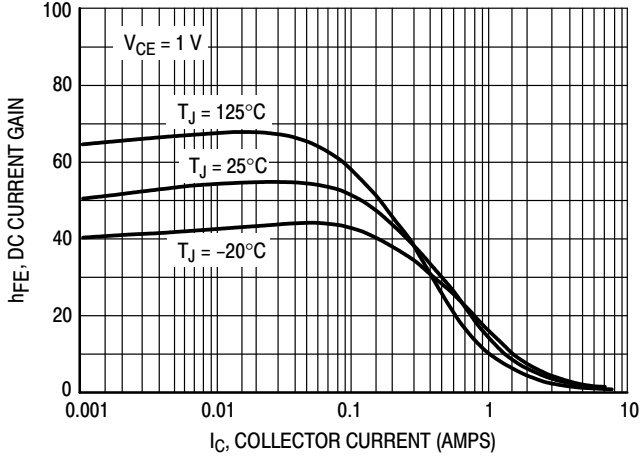

Figure 1. DC Current Gain @ 1 Volt

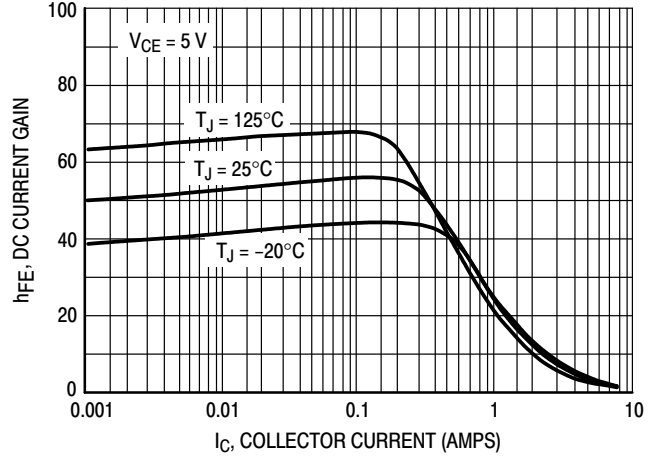

Figure 2. DC Current Gain @ 5 Volt

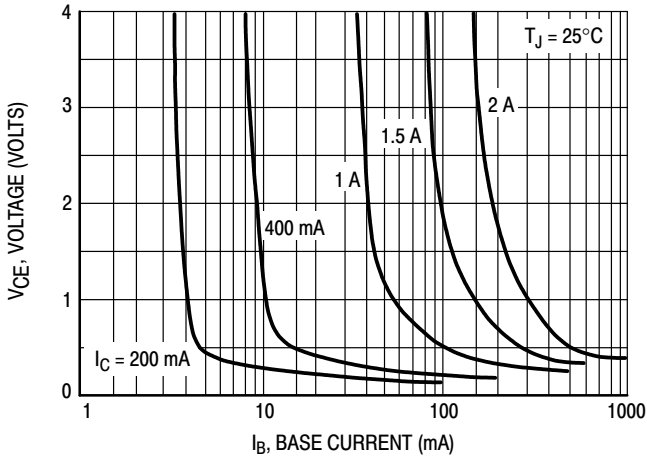

Figure 3. Collector Saturation Region

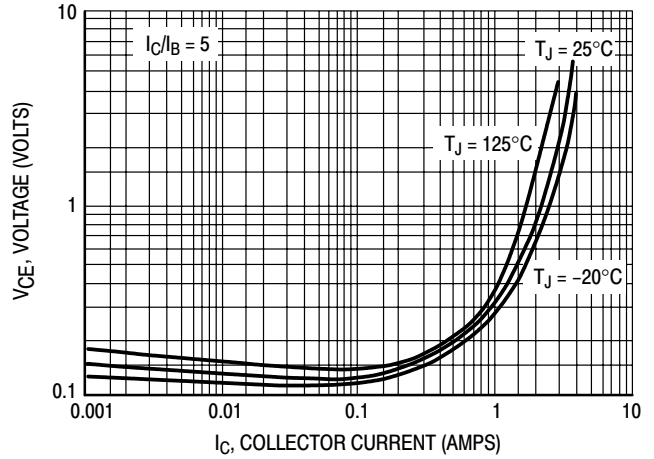

Figure 4. Collector-Emitter Saturation Voltage

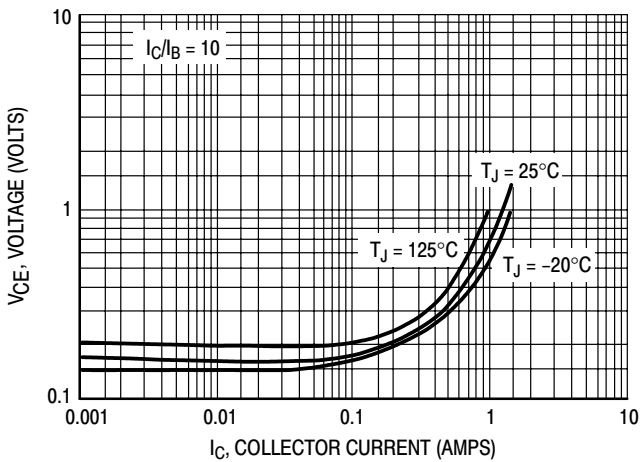

Figure 5. Collector-Emitter Saturation Voltage

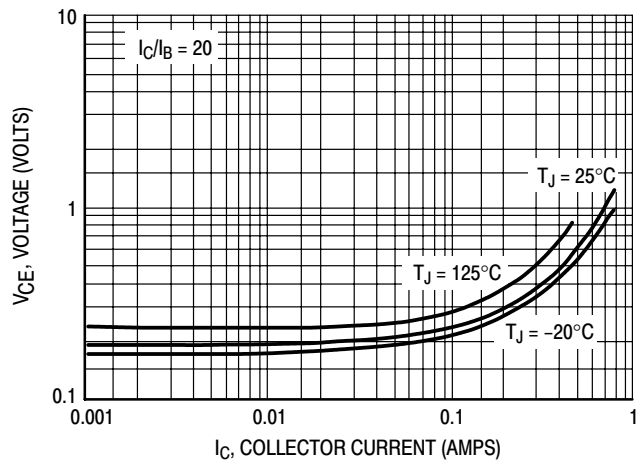

Figure 6. Collector-Emitter Saturation Voltage

BUD44D2

TYPICAL STATIC CHARACTERISTICS

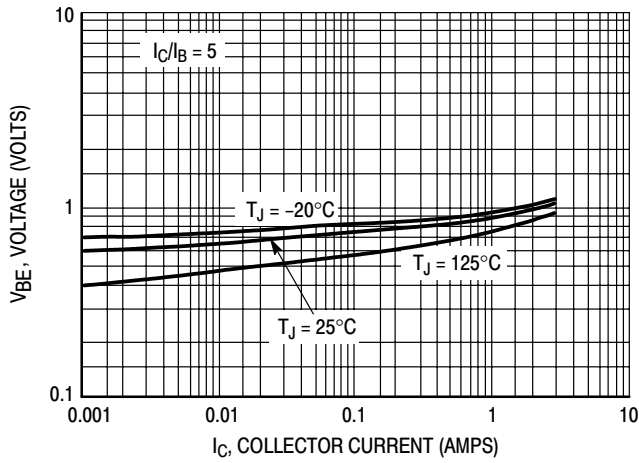

Figure 7A. Base-Emitter Saturation Region

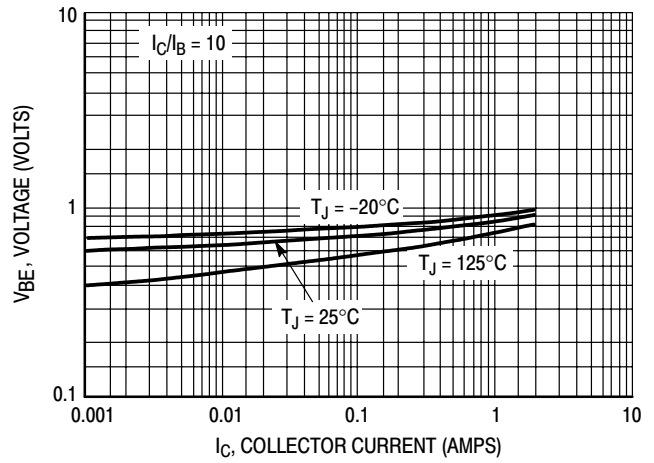

Figure 7B. Base-Emitter Saturation Region

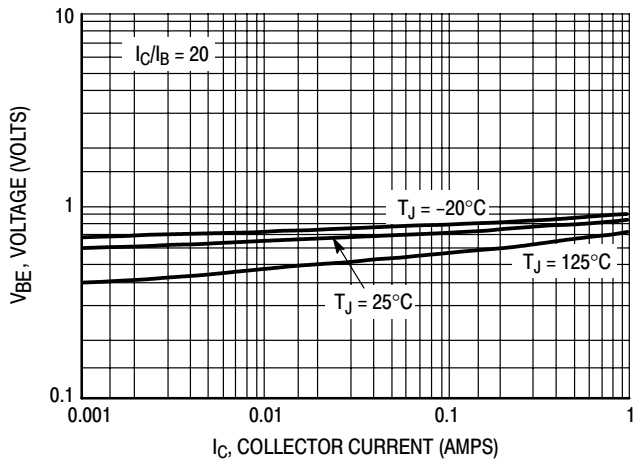

Figure 7C. Base-Emitter Saturation Region

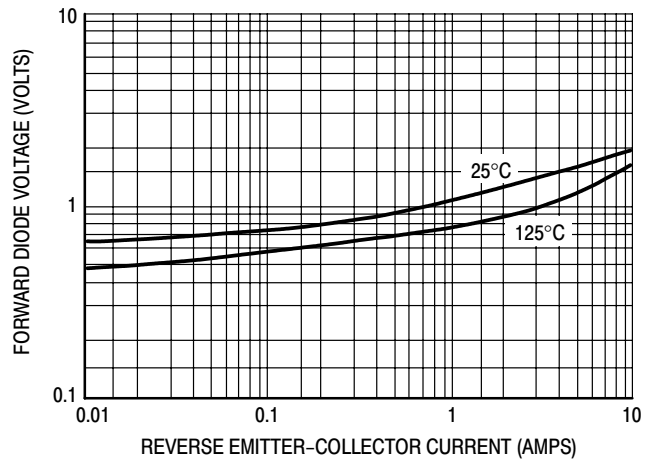

Figure 8. Forward Diode Voltage

TYPICAL SWITCHING CHARACTERISTICS

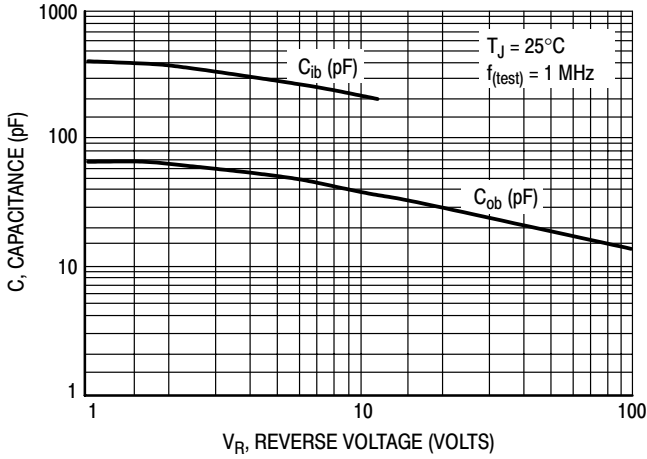

Figure 9. Capacitance

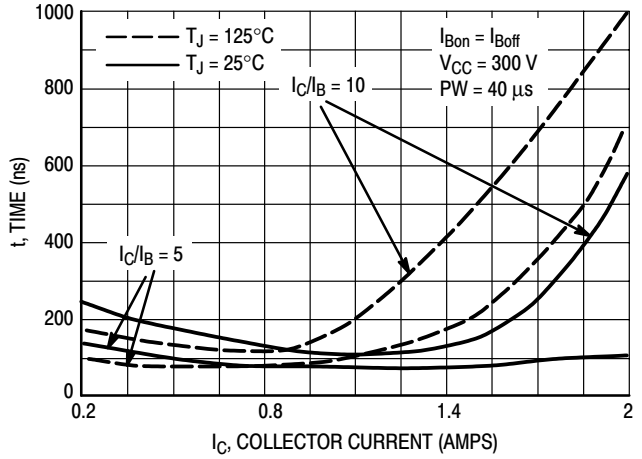

Figure 10. Resistive Switch Time, t_{on}

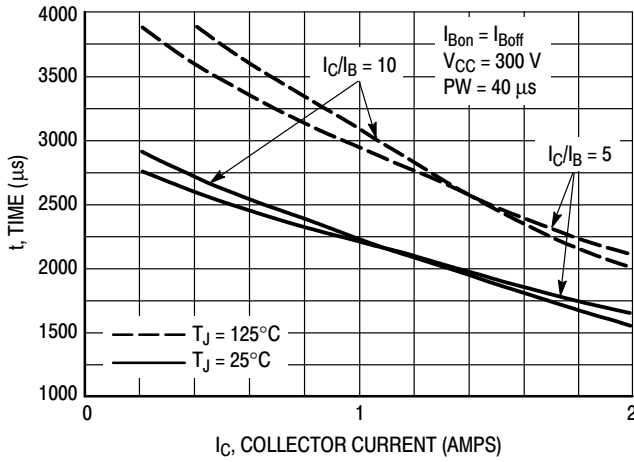

Figure 11. Resistive Switch Time, t_{off}

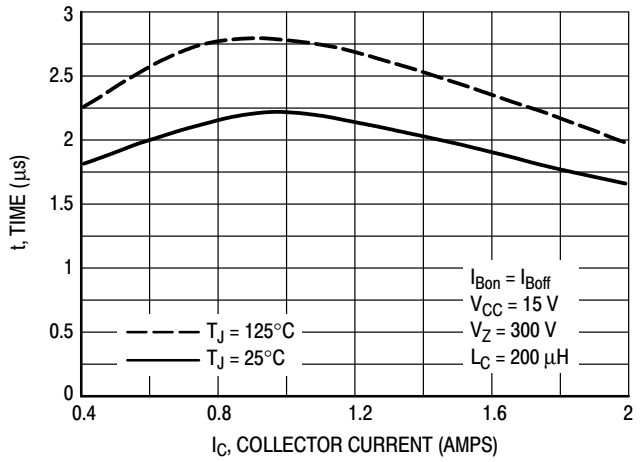

Figure 12. Inductive Storage Time, t_{si} @ $I_C/I_B = 5$

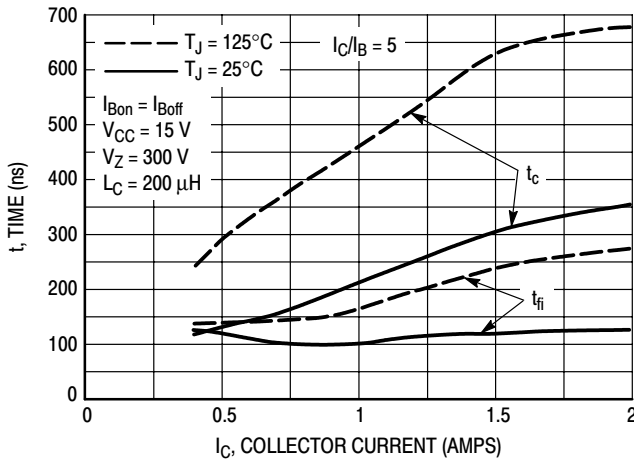

Figure 13. Inductive Switching, t_c & t_{rf} @ $I_C/I_B = 5$

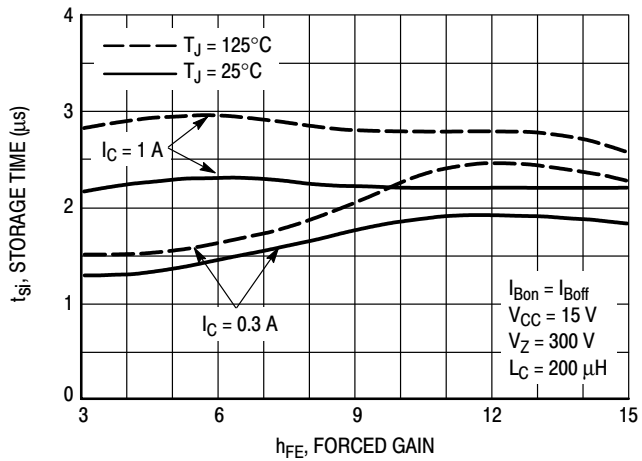

Figure 14. Inductive Storage Time

TYPICAL SWITCHING CHARACTERISTICS

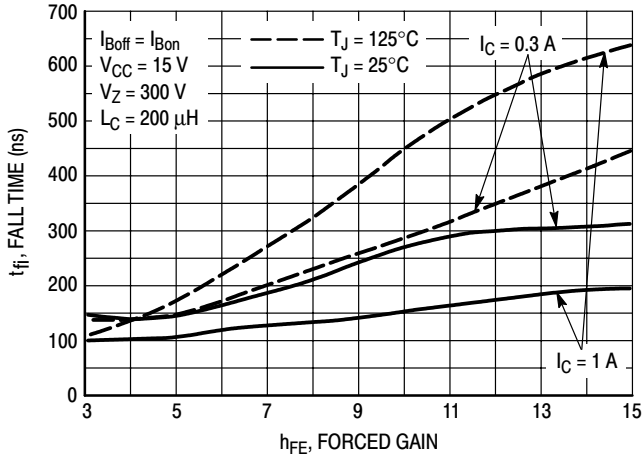

Figure 15. Inductive Fall Time

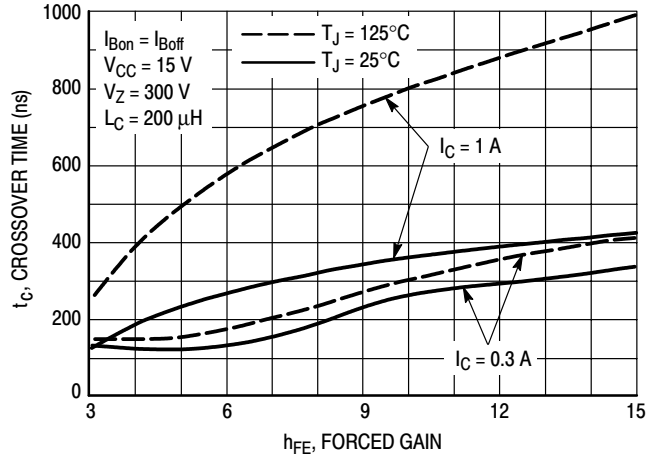

Figure 16. Inductive Crossover Time

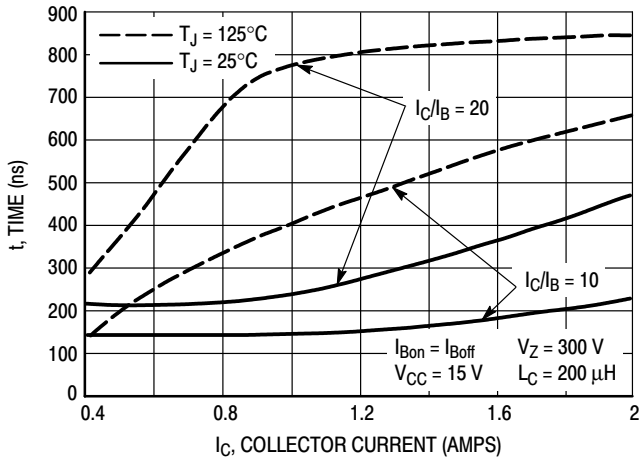

Figure 17. Inductive Switching, t_{fi}

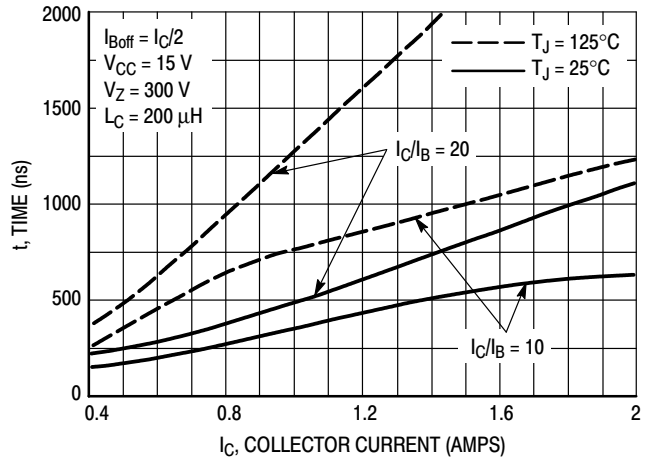

Figure 18. Inductive Switching, t_c

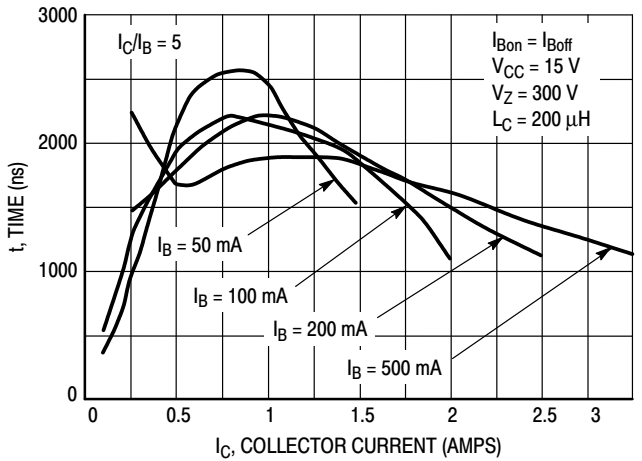

Figure 19. Inductive Storage Time, t_{si}

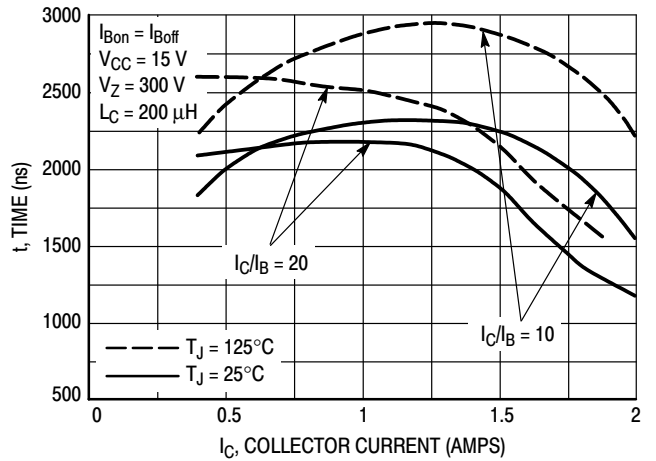

Figure 20. Inductive Storage Time, t_{si}

BUD44D2

TYPICAL SWITCHING CHARACTERISTICS

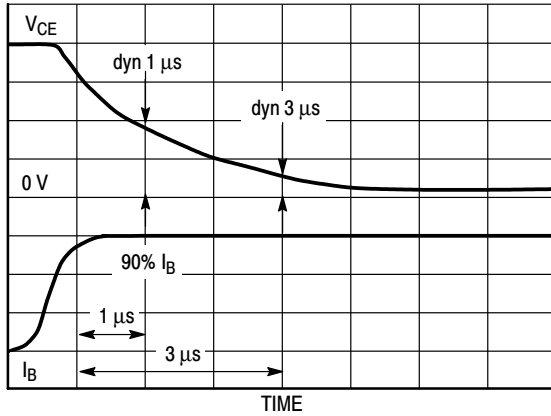

Figure 21. Dynamic Saturation Voltage Measurements

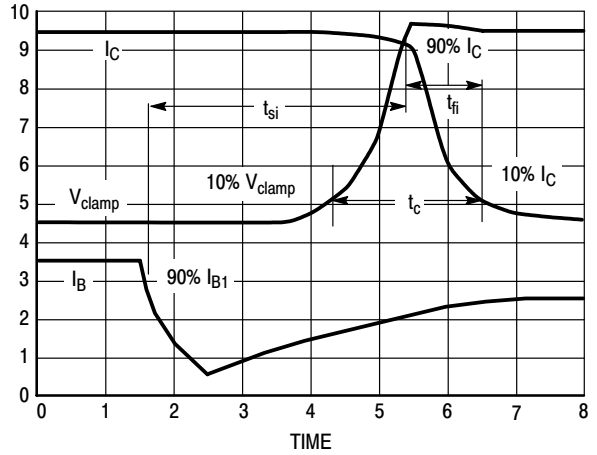

Figure 22. Inductive Switching Measurements

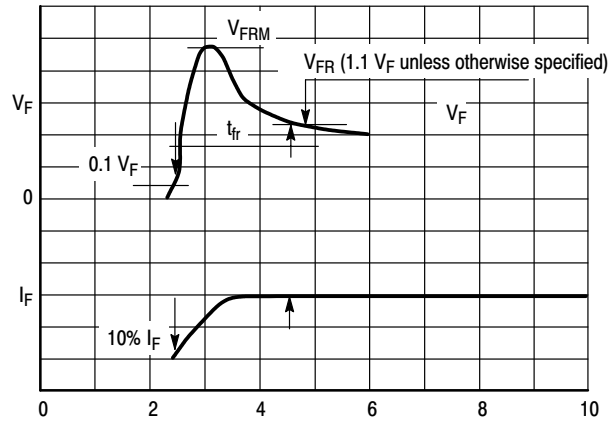
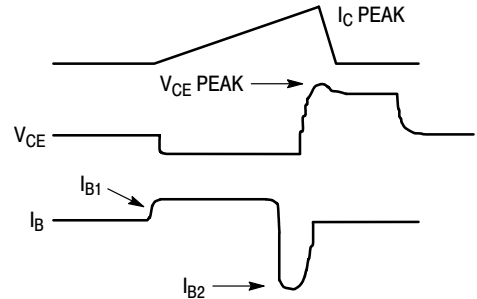
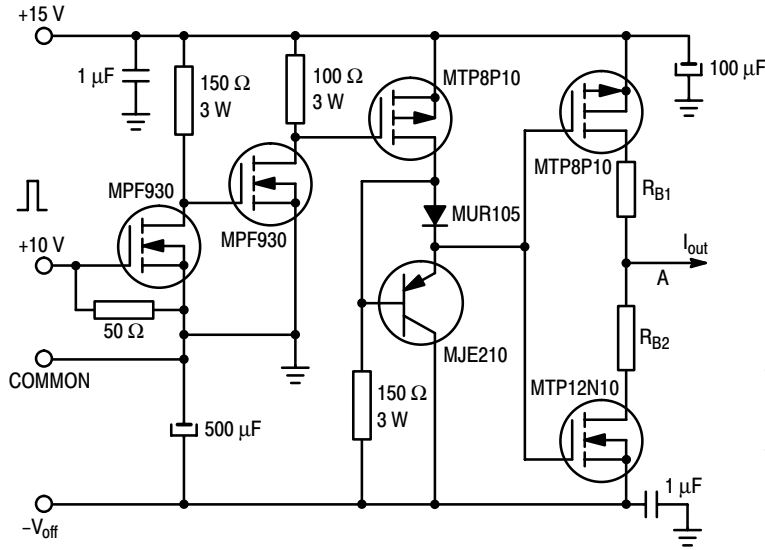

Figure 22 bis. t_{fr} Measurements

BUD44D2

TYPICAL SWITCHING CHARACTERISTICS

Table 1. Inductive Load Switching Drive Circuit



$V_{(BR)CEO(sus)}$
 $L = 10 \text{ mH}$
 $R_{B2} = \infty$
 $V_{CC} = 20 \text{ Volts}$
 $I_{C(pk)} = 100 \text{ mA}$

Inductive Switching
 $L = 200 \mu\text{H}$
 $R_{B2} = 0$
 $V_{CC} = 15 \text{ Volts}$
 R_{B1} selected for
 desired I_{B1}

RBSOA
 $L = 500 \mu\text{H}$
 $R_{B2} = 0$
 $V_{CC} = 15 \text{ Volts}$
 R_{B1} selected for
 desired I_{B1}

TYPICAL STATIC CHARACTERISTICS

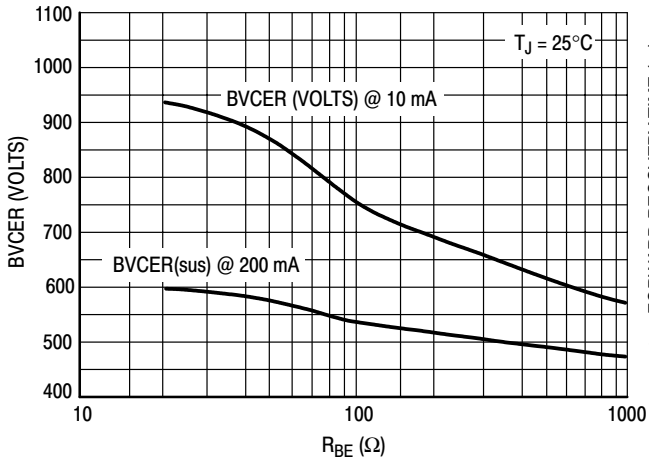

Figure 23. BVCEr

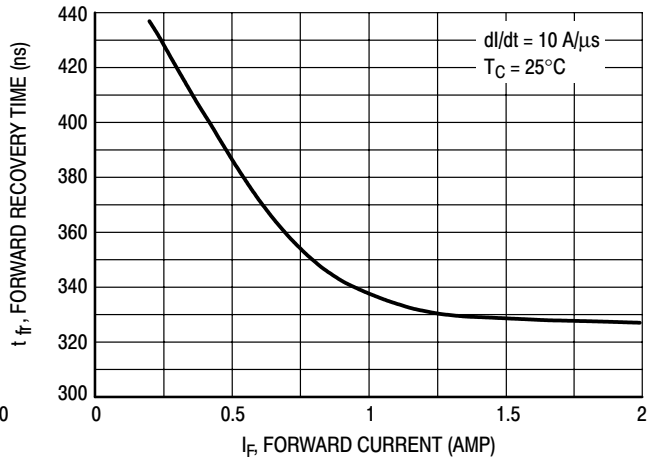
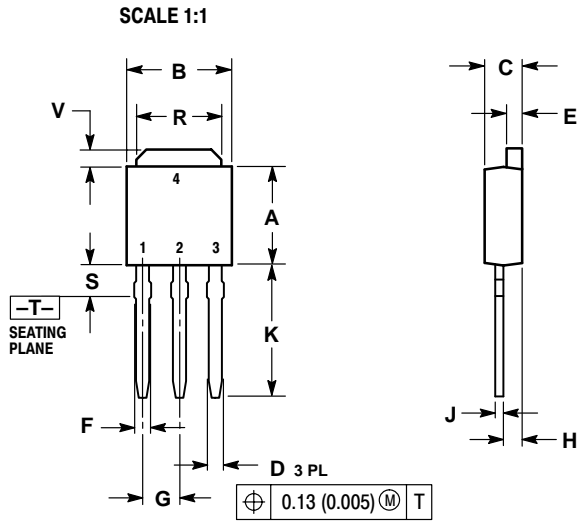

Figure 24. Forward Recovery Time t_{fr}

BUD44D2

PACKAGE DIMENSIONS DPAK CASE 369-07 ISSUE M



- NOTES:
1. DIMENSIONING AND TOLERANCING PER ANSI Y14.5M, 1982.
2. CONTROLLING DIMENSION: INCH.

INCHES		MILLIMETERS		
DIM	MIN	MAX	MIN	MAX
A	0.235	0.250	5.97	6.35
B	0.250	0.265	6.35	6.73
C	0.086	0.094	2.19	2.38
D	0.027	0.035	0.69	0.88
E	0.033	0.040	0.84	1.01
F	0.037	0.047	0.94	1.19
G	0.090 BSC		2.29 BSC	
H	0.034	0.040	0.87	1.01
J	0.018	0.023	0.46	0.58
K	0.350	0.380	8.89	9.65
R	0.175	0.215	4.45	5.46
S	0.050	0.090	1.27	2.28
V	0.030	0.050	0.77	1.27

DPAK CASE 369A-13 ISSUE AA

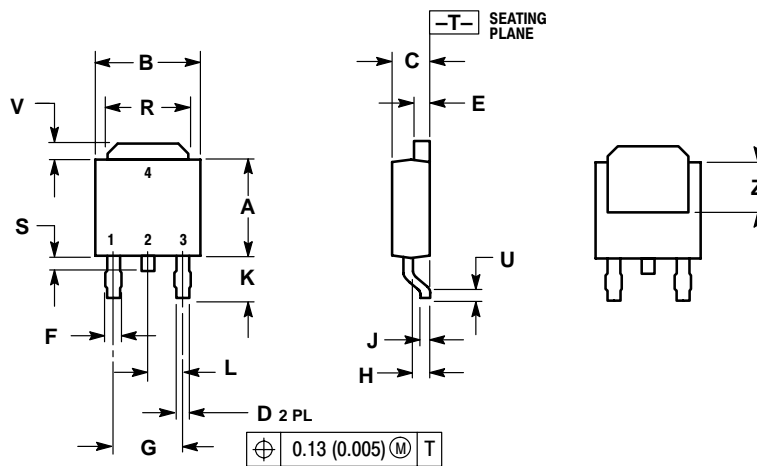

- NOTES:
1. DIMENSIONING AND TOLERANCING PER ANSI Y14.5M, 1982.
2. CONTROLLING DIMENSION: INCH.

INCHES		MILLIMETERS		
DIM	MIN	MAX	MIN	MAX
A	0.235	0.250	5.97	6.35
B	0.250	0.265	6.35	6.73
C	0.086	0.094	2.19	2.38
D	0.027	0.035	0.69	0.88
E	0.033	0.040	0.84	1.01
F	0.037	0.047	0.94	1.19
G	0.180 BSC		4.58 BSC	
H	0.034	0.040	0.87	1.01
J	0.018	0.023	0.46	0.58
K	0.102	0.114	2.60	2.89
L	0.090 BSC		2.29 BSC	
R	0.175	0.215	4.45	5.46
S	0.020	0.050	0.51	1.27
U	0.020	---	0.51	---
V	0.030	0.050	0.77	1.27
Z	0.138	---	3.51	---

ON Semiconductor and  are trademarks of Semiconductor Components Industries, LLC (SCILLC). SCILLC reserves the right to make changes without further notice to any products herein. SCILLC makes no warranty, representation or guarantee regarding the suitability of its products for any particular purpose, nor does SCILLC assume any liability arising out of the application or use of any product or circuit, and specifically disclaims any and all liability, including without limitation special, consequential or incidental damages. "Typical" parameters which may be provided in SCILLC data sheets and/or specifications can and do vary in different applications and actual performance may vary over time. All operating parameters, including "Typicals" must be validated for each customer application by customer's technical experts. SCILLC does not convey any license under its patent rights nor the rights of others. SCILLC products are not designed, intended, or authorized for use as components in systems intended for surgical implant into the body, or other applications intended to support or sustain life, or for any other application in which the failure of the SCILLC product could create a situation where personal injury or death may occur. Should Buyer purchase or use SCILLC products for any such unintended or unauthorized application, Buyer shall indemnify and hold SCILLC and its officers, employees, subsidiaries, affiliates, and distributors harmless against all claims, costs, damages, and expenses, and reasonable attorney fees arising out of, directly or indirectly, any claim of personal injury or death associated with such unintended or unauthorized use, even if such claim alleges that SCILLC was negligent regarding the design or manufacture of the part. SCILLC is an Equal Opportunity/Affirmative Action Employer.

PUBLICATION ORDERING INFORMATION

NORTH AMERICA Literature Fulfillment:

Literature Distribution Center for ON Semiconductor
P.O. Box 5163, Denver, Colorado 80217 USA
Phone: 303-675-2175 or 800-344-3860 Toll Free USA/Canada
Fax: 303-675-2176 or 800-344-3867 Toll Free USA/Canada
Email: ONlit@hibbertco.com
Fax Response Line: 303-675-2167 or 800-344-3810 Toll Free USA/Canada

N. American Technical Support: 800-282-9855 Toll Free USA/Canada

EUROPE: LDC for ON Semiconductor – European Support

German Phone: (+1) 303-308-7140 (Mon-Fri 2:30pm to 7:00pm CET)
Email: ONlit-german@hibbertco.com
French Phone: (+1) 303-308-7141 (Mon-Fri 2:00pm to 7:00pm CET)
Email: ONlit-french@hibbertco.com
English Phone: (+1) 303-308-7142 (Mon-Fri 12:00pm to 5:00pm GMT)
Email: ONlit@hibbertco.com

EUROPEAN TOLL-FREE ACCESS*: 00-800-4422-3781

*Available from Germany, France, Italy, UK, Ireland

CENTRAL/SOUTH AMERICA:

Spanish Phone: 303-308-7143 (Mon-Fri 8:00am to 5:00pm MST)
Email: ONlit-spanish@hibbertco.com
Toll-Free from Mexico: Dial 01-800-288-2872 for Access –
then Dial 866-297-9322

ASIA/PACIFIC: LDC for ON Semiconductor – Asia Support

Phone: 1-303-675-2121 (Tue-Fri 9:00am to 1:00pm, Hong Kong Time)
Toll Free from Hong Kong & Singapore:
001-800-4422-3781

Email: ONlit-asia@hibbertco.com

JAPAN: ON Semiconductor, Japan Customer Focus Center

4-32-1 Nishi-Gotanda, Shinagawa-ku, Tokyo, Japan 141-0031
Phone: 81-3-5740-2700
Email: r14525@onsemi.com

ON Semiconductor Website: <http://onsemi.com>

For additional information, please contact your local Sales Representative.