

CM1436-04DE

4-Channel EMI Filter Arrays with ESD Protection

Product Description

The CM1436 is an EMI filter array with ESD protection, which integrates four pi filters (C-R-C). Each CM1436 filter has component values of 15 pF – 200 Ω – 15 pF. These parts include ESD protection diodes on every pin, providing a very high level of protection for sensitive electronic components that may be subjected to electrostatic discharge (ESD). The ESD diodes connected to the filter ports safely dissipate ESD strikes of ±15 kV contact discharge, twice the specification requirement of the IEC 61000-4-2, Level 4 international standard. Using the MIL-STD-883 (Method 3015) specification for Human Body Model (HBM) ESD, the pins are protected for contact discharges at greater than ±30 kV.

This device is particularly well-suited for portable electronics (e.g. mobile handsets, PDAs, notebook computers) because of its small package and easy-to-use pin assignments. In particular, the CM1436 is ideal for EMI filtering and protecting data lines from ESD in wireless handsets.

The CM1436 is available in space-saving, low-profile, 8-lead 0.4 mm pitch WDFN packages. It is fabricated with the *Centurion*™ process and available with lead-free finishing.

Features

- Four Channels of EMI Filtering with ESD Protection
- Greater than 30 dB of Attenuation from 800 MHz to 3 GHz
- ±15 kV ESD Protection (IEC 61000-4-2, Contact Discharge)
- ±30 kV ESD Protection (HBM)
- Fabricated with *Centurion*™ Advanced Low Capacitance Zener Process Technology
- Space Saving, Low-Profile 8-Lead 0.4 mm Pitch WDFN Packages
- These Devices are Pb-Free and are RoHS Compliant

Applications

- I/O Port Protection for Mobile Handsets, Notebook Computers, PDAs, etc.
- EMI Filtering for Data Ports in Cell Phones, PDAs or Notebook Computers
- EMI Filtering for LCD, Camera and Chip-to-Chip Data Lines



ON Semiconductor®

<http://onsemi.com>



WDFN8
DE SUFFIX
CASE 511BF

ELECTRICAL SCHEMATIC

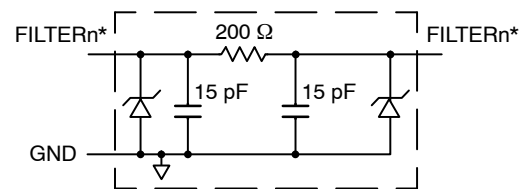

1 of 4 EMI Filtering + ESD Channels

* See Package/Pinout Diagrams for expanded pin information.

MARKING DIAGRAM

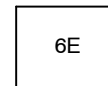

6E = CM1436-04DE

ORDERING INFORMATION

Device	Package	Shipping†
CM1436-04DE	WDFN-8 (Pb-Free)	3000/Tape & Reel

† For information on tape and reel specifications, including part orientation and tape sizes, please refer to our Tape and Reel Packaging Specification Brochure, BRD8011/D.

CM1436-04DE

Table 1. PIN DESCRIPTIONS

Pins	Name	Description
1	FILTER1	Filter Channel 1
2	FILTER2	Filter Channel 2
3	FILTER3	Filter Channel 3
4	FILTER4	Filter Channel 4
5	FILTER4	Filter Channel 4
6	FILTER3	Filter Channel 3
7	FILTER2	Filter Channel 2
8	FILTER1	Filter Channel 1
GND PAD	GND	Device Ground

PACKAGE / PINOUT DIAGRAMS

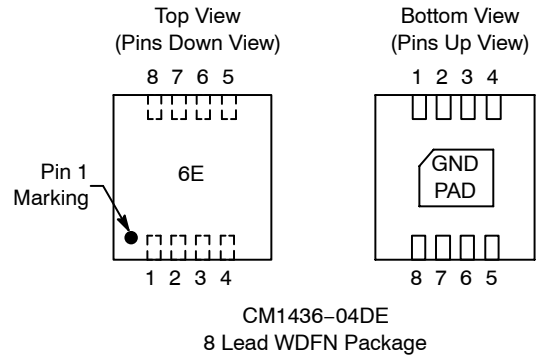

SPECIFICATIONS

Table 2. ABSOLUTE MAXIMUM RATINGS

Parameter	Rating	Units
Storage Temperature Range	-65 to +150	°C
DC Power per Resistor	100	mW
Package DC Power Rating	300	mW

Stresses exceeding Maximum Ratings may damage the device. Maximum Ratings are stress ratings only. Functional operation above the Recommended Operating Conditions is not implied. Extended exposure to stresses above the Recommended Operating Conditions may affect device reliability.

Table 3. STANDARD OPERATING CONDITIONS

Parameter	Rating	Units
Operating Temperature Range	-40 to +85	°C

Table 4. ELECTRICAL OPERATING CHARACTERISTICS (Note 1)

Symbol	Parameter	Conditions	Min	Typ	Max	Units
R	Resistance		160	200	240	Ω
C _{TOTAL}	Total Channel Capacitance	At 2.5 V DC, 1 MHz, 30 mV AC	24	30	36	pF
C	Capacitance C	At 2.5 V DC, 1 MHz, 30 mV AC	12	15	18	pF
I _{LEAK}	Diode Leakage Current (Reverse Bias)	V _{DIODE} = 3.3 V		0.1	1.0	μA
V _{SIG}	Signal Voltage Positive Clamp Negative Clamp	I _{LOAD} = 10 mA I _{LOAD} = -10 mA	5.6 -0.4	6.8 -0.8		V
V _{ESD}	In-system ESD Withstand Voltage a) Human Body Model, MIL-STD-883, Method 3015 b) Contact Discharge per IEC 61000-4-2 Level 4	(Note 2)	±30 ±15			kV

1. T_A = 25°C unless otherwise specified.
2. ESD applied to input and output pins with respect to GND, one at a time.

CM1436-04DE

PERFORMANCE INFORMATION

Typical Filter Performance (nominal conditions unless specified otherwise, 0 V DC Bias, 50 Ω Environment)

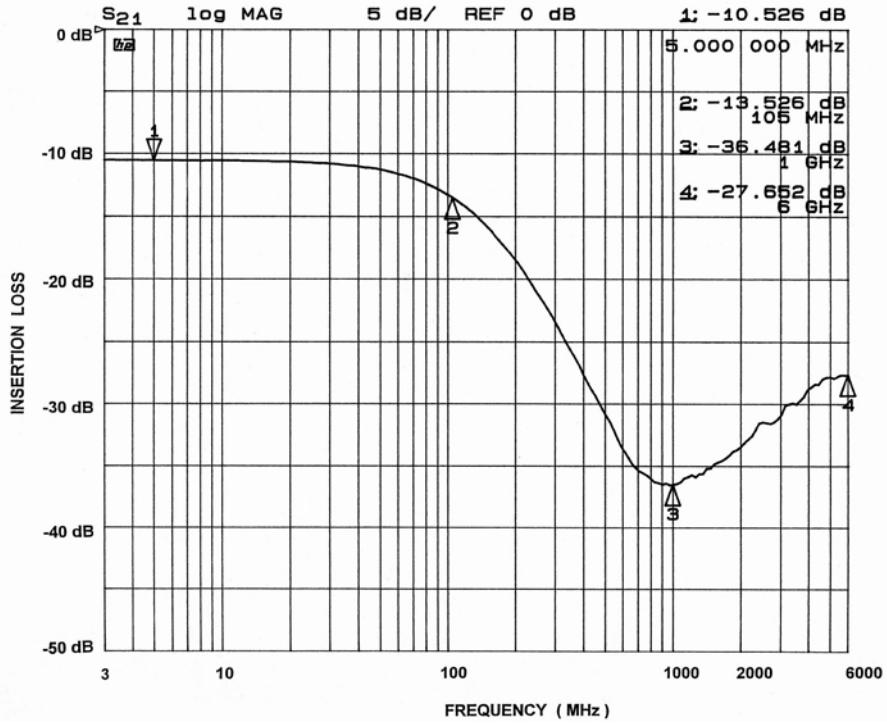

Figure 1. Channel 1 EMI Filter Performance

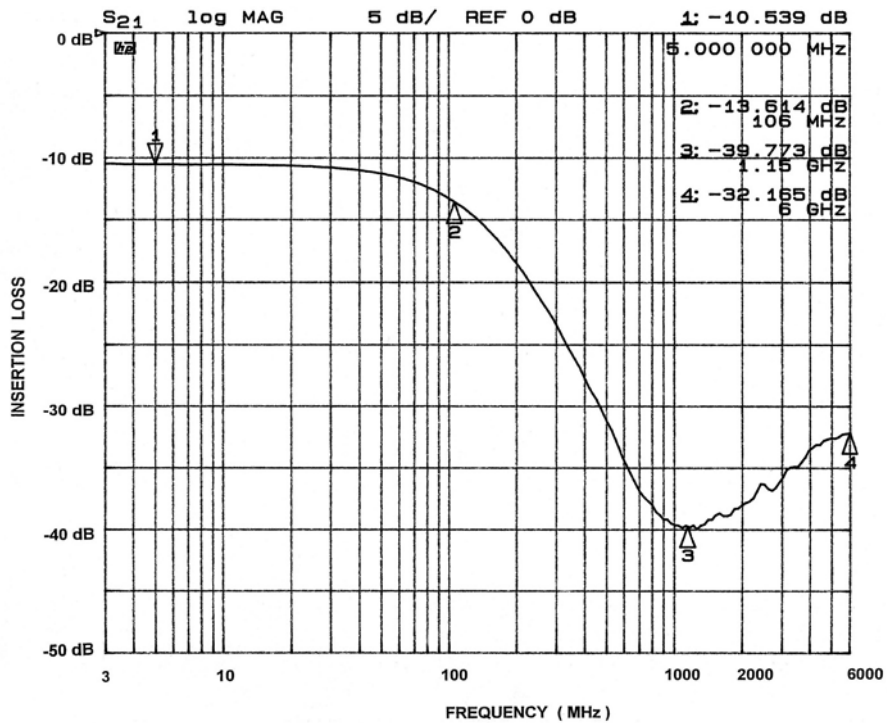

Figure 2. Channel 2 EMI Filter Performance

CM1436-04DE

PERFORMANCE INFORMATION (Cont'd)

Typical Filter Performance (nominal conditions unless specified otherwise, 0 V DC Bias, 50 Ω Environment)

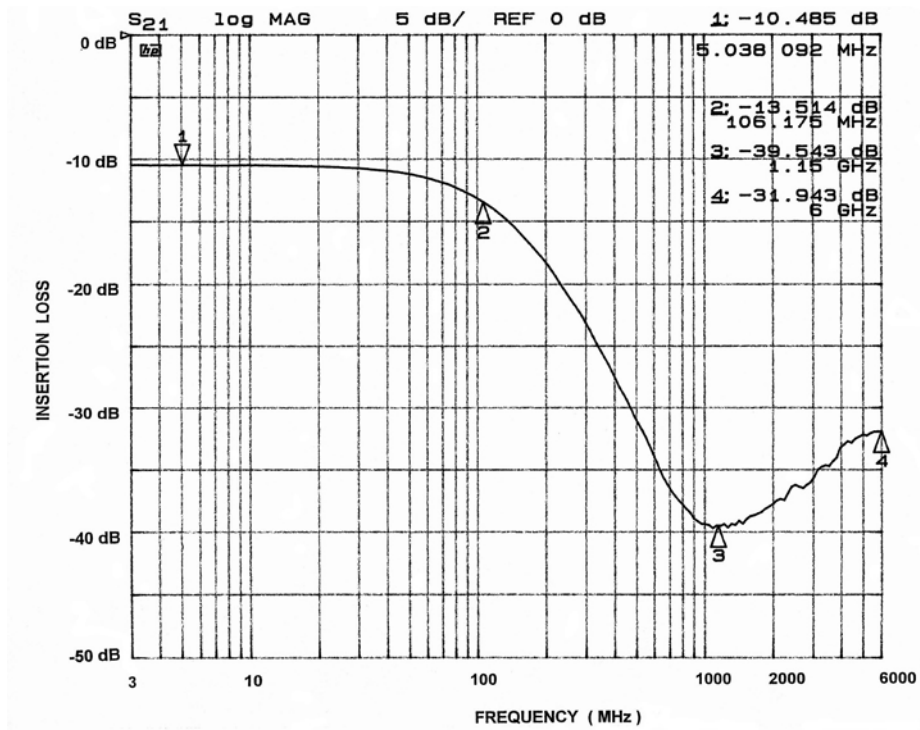

Figure 3. Channel 3 EMI Filter Performance

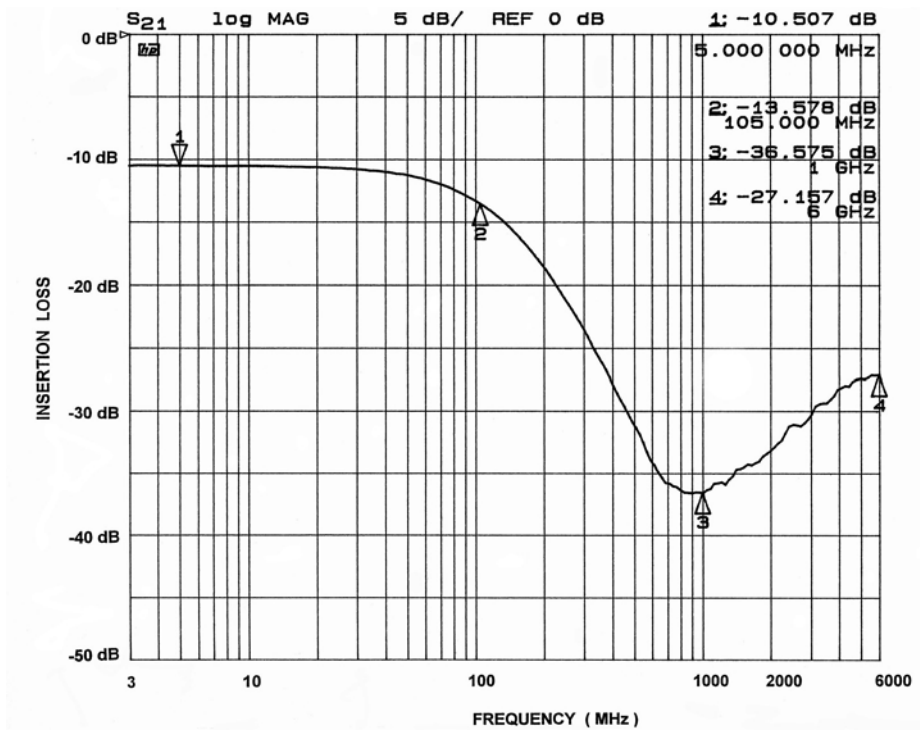

Figure 4. Channel 4 EMI Filter Performance

PERFORMANCE INFORMATION (Cont'd)

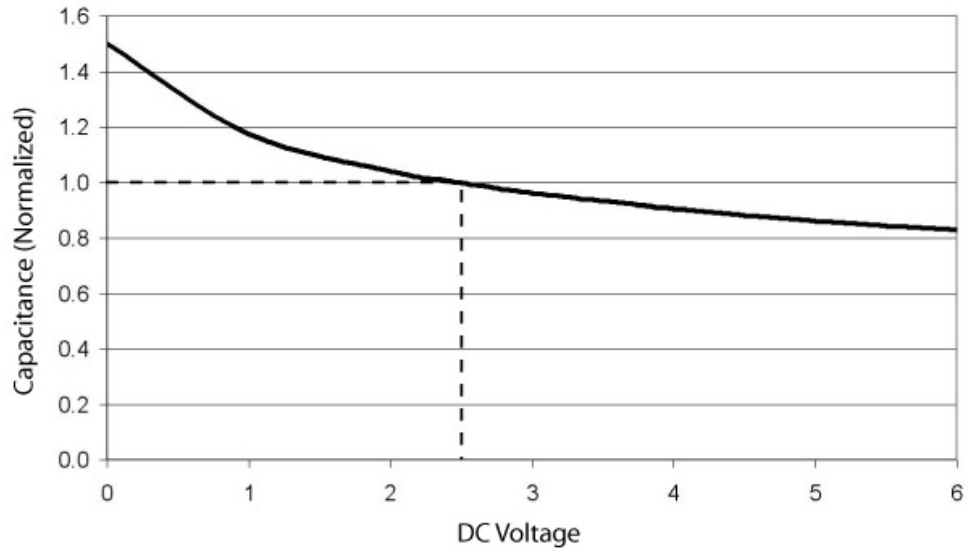
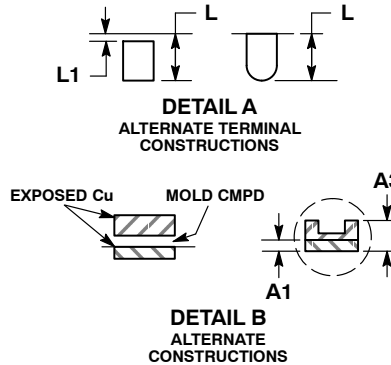
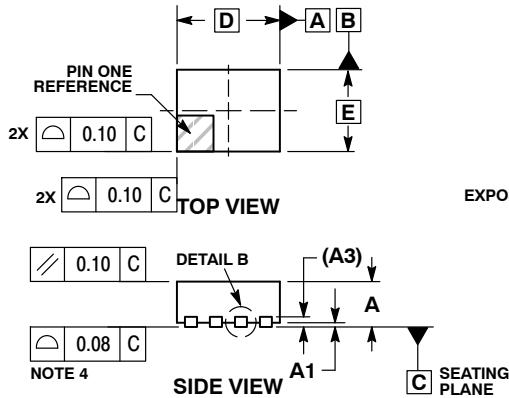

Figure 5. Filter Capacitance vs. Input Voltage over Temperature (normalized to capacitance at 2.5 V DC and 25°C)

CM1436-04DE

PACKAGE DIMENSIONS

WDFN8, 1.7x1.35, 0.4P
CASE 511BF-01
ISSUE 0



NOTES:

1. DIMENSIONING AND TOLERANCING PER ASME Y14.5M, 1994.
2. CONTROLLING DIMENSION: MILLIMETERS.
3. DIMENSION b APPLIES TO PLATED TERMINAL AND IS MEASURED BETWEEN 0.15 AND 0.30 MM FROM TERMINAL TIP.
4. COPLANARITY APPLIES TO THE EXPOSED PAD AS WELL AS THE TERMINALS.

DIM	MILLIMETERS	
	MIN	MAX
A	0.70	0.80
A1	0.00	0.05
A3	0.20	REF
b	0.15	0.25
D	1.7	BSC
D2	1.10	1.30
E	1.35	BSC
E2	0.30	0.50
e	0.40	BSC
K	0.22	REF
L	0.15	0.35
L1	---	0.15

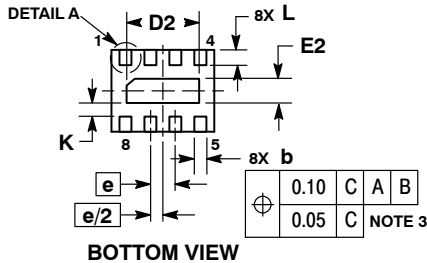

RECOMMENDED SOLDERING FOOTPRINT*

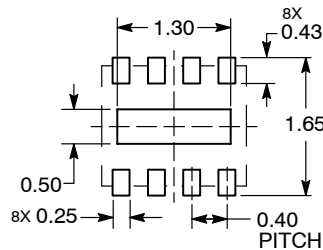

DIMENSION: MILLIMETERS

*For additional information on our Pb-Free strategy and soldering details, please download the ON Semiconductor Soldering and Mounting Techniques Reference Manual, SOLDERRM/D.

Centurion is a trademark of Semiconductor Components Industries, LCC (SCILCC).

ON Semiconductor and are registered trademarks of Semiconductor Components Industries, LLC (SCILLC). SCILLC reserves the right to make changes without further notice to any products herein. SCILLC makes no warranty, representation or guarantee regarding the suitability of its products for any particular purpose, nor does SCILLC assume any liability arising out of the application or use of any product or circuit, and specifically disclaims any and all liability, including without limitation special, consequential or incidental damages. "Typical" parameters which may be provided in SCILLC data sheets and/or specifications can and do vary in different applications and actual performance may vary over time. All operating parameters, including "Typicals" must be validated for each customer application by customer's technical experts. SCILLC does not convey any license under its patent rights nor the rights of others. SCILLC products are not designed, intended, or authorized for use as components in systems intended for surgical implant into the body, or other applications intended to support or sustain life, or for any other application in which the failure of the SCILLC product could create a situation where personal injury or death may occur. Should Buyer purchase or use SCILLC products for any such unintended or unauthorized application, Buyer shall indemnify and hold SCILLC and its officers, employees, subsidiaries, affiliates, and distributors harmless against all claims, costs, damages, and expenses, and reasonable attorney fees arising out of, directly or indirectly, any claim of personal injury or death associated with such unintended or unauthorized use, even if such claim alleges that SCILLC was negligent regarding the design or manufacture of the part. SCILLC is an Equal Opportunity/Affirmative Action Employer. This literature is subject to all applicable copyright laws and is not for resale in any manner.

PUBLICATION ORDERING INFORMATION

LITERATURE FULFILLMENT:
Literature Distribution Center for ON Semiconductor
P.O. Box 5163, Denver, Colorado 80217 USA
Phone: 303-675-2175 or 800-344-3860 Toll Free USA/Canada
Fax: 303-675-2176 or 800-344-3867 Toll Free USA/Canada
Email: orderlit@onsemi.com

N. American Technical Support: 800-282-9855 Toll Free USA/Canada
Europe, Middle East and Africa Technical Support:
Phone: 421 33 790 2910
Japan Customer Focus Center
Phone: 81-3-5773-3850

ON Semiconductor Website: www.onsemi.com
Order Literature: <http://www.onsemi.com/orderlit>
For additional information, please contact your local Sales Representative