

DTA114GE



Product Preview

General Purpose Transistor PNP Bipolar Junction Transistor with a 10 kΩ Base–Emitter Resistor

ON Semiconductor®

<http://onsemi.com>

MAXIMUM RATINGS (T_J = 25°C unless otherwise noted)

| Rating | Symbol | Value | Unit |
|---|------------------|------------|------|
| Collector–Emitter Voltage | V _{CEO} | 50 | V |
| Collector–Base Voltage | V _{CBO} | 50 | V |
| Emitter–Base Voltage | V _{EBO} | 5.0 | V |
| Collector Current | I _C | 100 | mA |
| Base Current | I _B | 20 | mA |
| Total Power Dissipation @ T _C = 25°C | P _D | 150 | mW |
| Total Power Dissipation @ T _C = 85°C | P _D | 78 | mW |
| Thermal Resistance Junction to Ambient (1) | R _{θJA} | 833 | °C/W |
| Operating and Storage Temperature Range | | -55 to 150 | °C |

1. Minimum FR-4 or G-10 PCB, Operating to Steady State.

50 VOLTS
100 mAmps, 150 mW

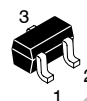

CASE 463-01
SOT-416/SC-90

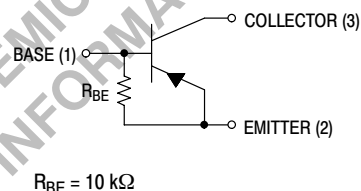

ELECTRICAL CHARACTERISTICS (T_C = 25°C unless otherwise noted)

| Characteristic | Symbol | Min | Typ | Max | Unit |
|---|----------------------|-----|-----|-----|------|
| OFF CHARACTERISTICS | | | | | |
| Collector–Emitter Breakdown Voltage (I _C = 50 μAdc) | BV _{CBO} | 50 | — | — | Vdc |
| Collector–Emitter Breakdown Voltage (I _C = 1.0 mAdc) | BV _{CEO} | 50 | — | — | Vdc |
| Collector–Emitter Breakdown Voltage (I _E = 720 μAdc) | BV _{EBO} | 5.0 | — | — | Vdc |
| Collector Cutoff Current (V _{CB} = 50 Vdc, I _E = 0 Adc) | I _{CBO} | — | — | 0.5 | μAdc |
| Emitter Cutoff Current (V _{EB} = 4.0 Vdc, I _C = 0 Adc) | I _{EBO} | 300 | — | 580 | μAdc |
| ON CHARACTERISTICS | | | | | |
| DC Current Gain (V _{CE} = 5.0 Vdc, I _C = 5.0 mAdc) | h _{FE} | 30 | — | — | |
| Collector–Emitter Saturation Voltage (I _C = 10 mAdc, I _B = 500 μAdc) | V _{CE(sat)} | — | — | 0.3 | Vdc |

This document contains information on a product under development. Motorola reserves the right to change or discontinue this product without notice.

TYPICAL ELECTRICAL CHARACTERISTICS

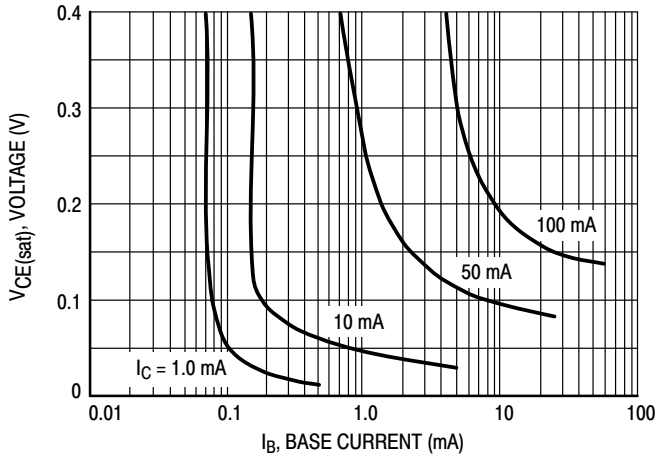

Figure 1. Collector-Emitter Saturation Voltage

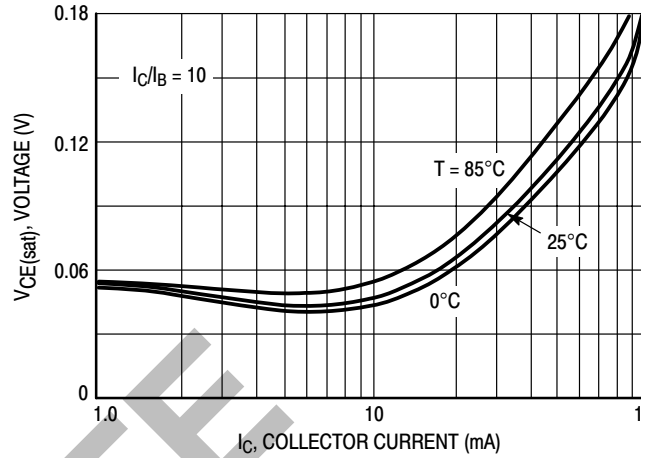

Figure 2. Collector-Emitter Saturation Voltage

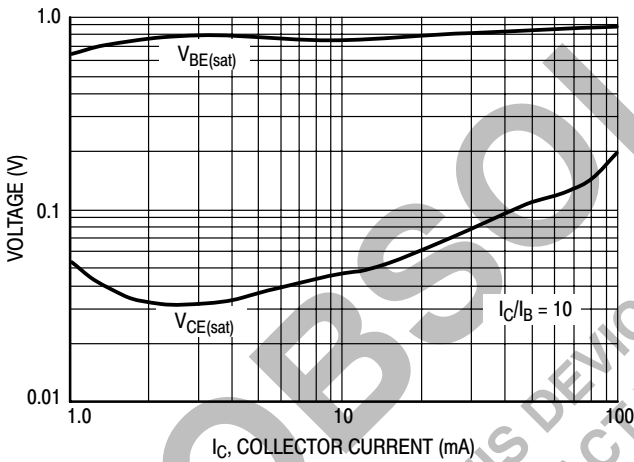

Figure 3. "On" Voltages

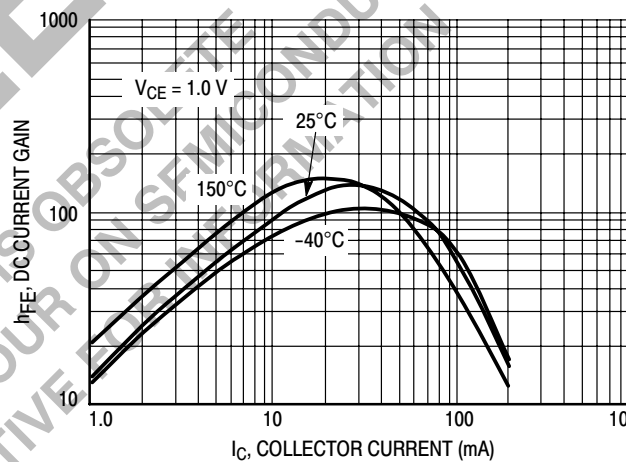

Figure 4. DC Current Gain

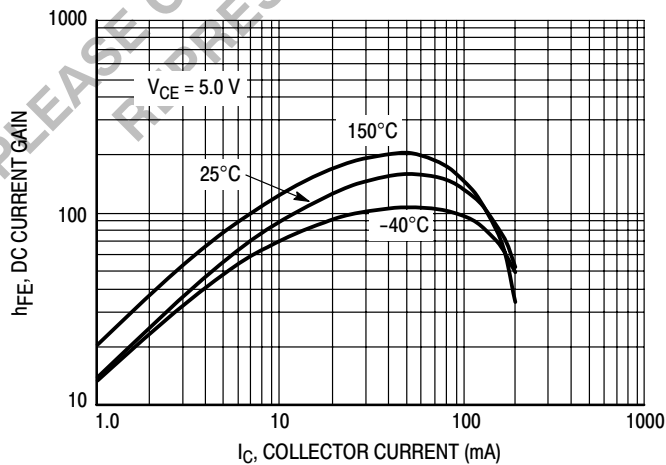
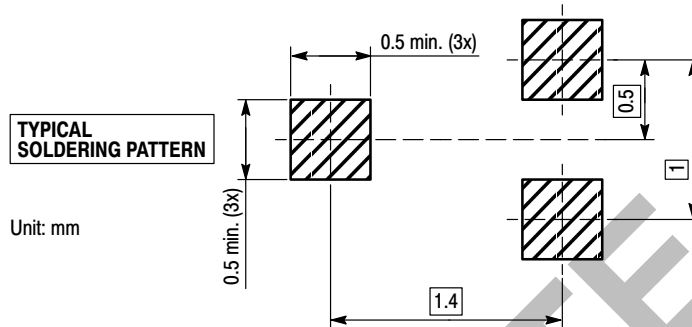

Figure 5. DC Current Gain

MINIMUM RECOMMENDED FOOTPRINTS FOR SURFACE MOUNTED APPLICATIONS

Surface mount board layout is a critical portion of the total design. The footprint for the semiconductor packages must be the correct size to insure proper solder connection

interface between the board and the package. With the correct pad geometry, the packages will self align when subjected to a solder reflow process.



SOT-416/SC-90 POWER DISSIPATION

The power dissipation of the SOT-416/SC-90 is a function of the pad size. This can vary from the minimum pad size for soldering to the pad size given for maximum power dissipation. Power dissipation for a surface mount device is determined by $T_{J(max)}$, the maximum rated junction temperature of the die, $R_{\theta JA}$, the thermal resistance from the device junction to ambient; and the operating temperature, T_A . Using the values provided on the data sheet, P_D can be calculated as follows:

$$P_D = \frac{T_{J(max)} - T_A}{R_{\theta JA}}$$

The values for the equation are found in the maximum ratings table on the data sheet. Substituting these values

into the equation for an ambient temperature T_A of 25°C, one can calculate the power dissipation of the device which in this case is 150 milliwatts.

$$P_D = \frac{150^\circ\text{C} - 25^\circ\text{C}}{833^\circ\text{C/W}} = 150 \text{ milliwatts}$$

The 833°C/W assumes the use of the recommended footprint on a glass epoxy printed circuit board to achieve a power dissipation of 150 milliwatts. Another alternative would be to use a ceramic substrate or an aluminum core board such as Thermal Clad™. Using a board material such as Thermal Clad, a higher power dissipation can be achieved using the same footprint.

SOLDERING PRECAUTIONS

The melting temperature of solder is higher than the rated temperature of the device. When the entire device is heated to a high temperature, failure to complete soldering within a short time could result in device failure. Therefore, the following items should always be observed in order to minimize the thermal stress to which the devices are subjected.

- Always preheat the device.
- The delta temperature between the preheat and soldering should be 100°C or less.*
- When preheating and soldering, the temperature of the leads and the case must not exceed the maximum temperature ratings as shown on the data sheet. When using infrared heating with the reflow soldering method, the difference should be a maximum of 10°C.
- The soldering temperature and time should not exceed 260°C for more than 10 seconds.

- When shifting from preheating to soldering, the maximum temperature gradient should be 5°C or less.
- After soldering has been completed, the device should be allowed to cool naturally for at least three minutes. Gradual cooling should be used as the use of forced cooling will increase the temperature gradient and result in latent failure due to mechanical stress.
- Mechanical stress or shock should not be applied during cooling.

* Soldering a device without preheating can cause excessive thermal shock and stress which can result in damage to the device.

SOLDER STENCIL GUIDELINES

Prior to placing surface mount components onto a printed circuit board, solder paste must be applied to the pads. A solder stencil is required to screen the optimum amount of solder paste onto the footprint. The stencil is made of brass

or stainless steel with a typical thickness of 0.008 inches. The stencil opening size for the surface mounted package should be the same as the pad size on the printed circuit board, i.e., a 1:1 registration.

TYPICAL SOLDER HEATING PROFILE

For any given circuit board, there will be a group of control settings that will give the desired heat pattern. The operator must set temperatures for several heating zones, and a figure for belt speed. Taken together, these control settings make up a heating "profile" for that particular circuit board. On machines controlled by a computer, the computer remembers these profiles from one operating session to the next. Figure 6 shows a typical heating profile for use when soldering a surface mount device to a printed circuit board. This profile will vary among soldering systems but it is a good starting point. Factors that can affect the profile include the type of soldering system in use, density and types of components on the board, type of solder used, and the type of board or substrate material being used. This profile shows temperature versus time. The line on the

graph shows the actual temperature that might be experienced on the surface of a test board at or near a central solder joint. The two profiles are based on a high density and a low density board. The Vitronics SMD310 convection/infrared reflow soldering system was used to generate this profile. The type of solder used was 62/36/2 Tin Lead Silver with a melting point between 177–189°C. When this type of furnace is used for solder reflow work, the circuit boards and solder joints tend to heat first. The components on the board are then heated by conduction. The circuit board, because it has a large surface area, absorbs the thermal energy more efficiently, then distributes this energy to the components. Because of this effect, the main body of a component may be up to 30 degrees cooler than the adjacent solder joints.

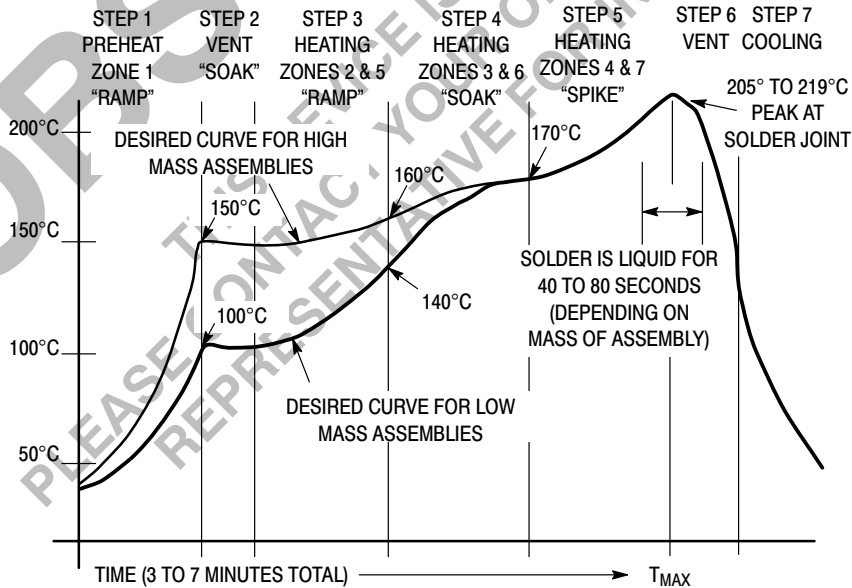
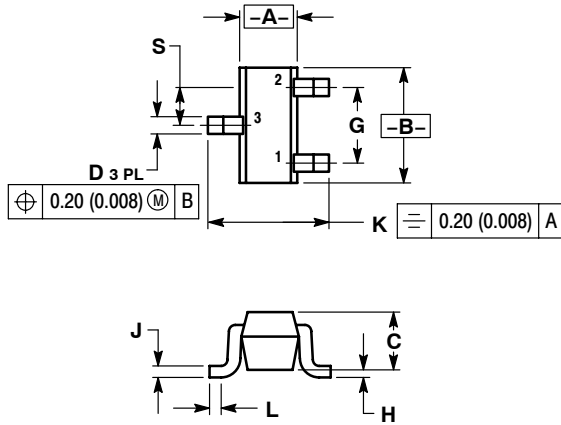

Figure 6. Typical Solder Heating Profile

DTA114GE

PACKAGE DIMENSIONS

CASE 463-01
ISSUE A
SOT-416/SC-90



STYLE 1:
PIN 1. BASE
2. EMITTER
3. COLLECTOR

- NOTES:
1. DIMENSIONING AND TOLERANCING PER ANSI Y14.5M, 1982.
2. CONTROLLING DIMENSION: MILLIMETER.

| DIM | MILLIMETERS | | INCHES | |
|-----|-------------|------|-----------|-------|
| | MIN | MAX | MIN | MAX |
| A | 0.70 | 0.80 | 0.028 | 0.031 |
| B | 1.40 | 1.80 | 0.055 | 0.071 |
| C | 0.60 | 0.90 | 0.024 | 0.035 |
| D | 0.15 | 0.30 | 0.006 | 0.012 |
| G | 1.00 BSC | | 0.039 BSC | |
| H | --- | 0.10 | --- | 0.004 |
| J | 0.10 | 0.25 | 0.004 | 0.010 |
| K | 1.45 | 1.75 | 0.057 | 0.069 |
| L | 0.10 | 0.20 | 0.004 | 0.008 |
| S | 0.50 BSC | | 0.020 BSC | |

OBSOLETE

THIS DEVICE IS OBSOLETE
PLEASE CONTACT YOUR ON SEMICONDUCTOR
REPRESENTATIVE FOR INFORMATION

Thermal Clad is a trademark of the Bergquist Company

ON Semiconductor and  are registered trademarks of Semiconductor Components Industries, LLC (SCILLC). SCILLC reserves the right to make changes without further notice to any products herein. SCILLC makes no warranty, representation or guarantee regarding the suitability of its products for any particular purpose, nor does SCILLC assume any liability arising out of the application or use of any product or circuit, and specifically disclaims any and all liability, including without limitation special, consequential or incidental damages. "Typical" parameters which may be provided in SCILLC data sheets and/or specifications can and do vary in different applications and actual performance may vary over time. All operating parameters, including "Typicals" must be validated for each customer application by customer's technical experts. SCILLC does not convey any license under its patent rights nor the rights of others. SCILLC products are not designed, intended, or authorized for use as components in systems intended for surgical implant into the body, or other applications intended to support or sustain life, or for any other application in which the failure of the SCILLC product could create a situation where personal injury or death may occur. Should Buyer purchase or use SCILLC products for any such unintended or unauthorized application, Buyer shall indemnify and hold SCILLC and its officers, employees, subsidiaries, affiliates, and distributors harmless against all claims, costs, damages, and expenses, and reasonable attorney fees arising out of, directly or indirectly, any claim of personal injury or death associated with such unintended or unauthorized use, even if such claim alleges that SCILLC was negligent regarding the design or manufacture of the part. SCILLC is an Equal Opportunity/Affirmative Action Employer. This literature is subject to all applicable copyright laws and is not for resale in any manner.

PUBLICATION ORDERING INFORMATION

LITERATURE FULFILLMENT:
Literature Distribution Center for ON Semiconductor
P.O. Box 5163, Denver, Colorado 80217 USA
Phone: 303-675-2175 or 800-344-3860 Toll Free USA/Canada
Fax: 303-675-2176 or 800-344-3867 Toll Free USA/Canada
Email: orderlit@onsemi.com

N. American Technical Support: 800-282-9855 Toll Free
USA/Canada
Europe, Middle East and Africa Technical Support:
Phone: 421 33 790 2910
Japan Customer Focus Center
Phone: 81-3-5773-3850

ON Semiconductor Website: www.onsemi.com
Order Literature: <http://www.onsemi.com/orderlit>
For additional information, please contact your local
Sales Representative