



ECH8673

Power MOSFET

40V, 3.5A, 85mΩ, -40V -2.5A, 163mΩ, Complementary Dual ECH8

ON Semiconductor®

<http://onsemi.com>

Features

- ON-resistance Nch: $R_{DS(on)1}=65m\Omega$ (typ.), Pch: ON-resistance $R_{DS(on)1}=125m\Omega$ (typ.)
- 4V drive
- Halogen free compliance
- Nch+Pch MOSFET

Specifications

Absolute Maximum Ratings at $T_a=25^\circ C$

Parameter	Symbol	Conditions	N-channel	P-channel	Unit
Drain to Source Voltage	V_{DSS}		40	-40	V
Gate to Source Voltage	V_{GSS}		± 20	± 20	V
Drain Current (DC)	I_D		3.5	-2.5	A
Drain Current (Pulse)	I_{DP}	$PW \leq 10\mu s$, duty cycle $\leq 1\%$	30	-30	A
Allowable Power Dissipation	P_D	When mounted on ceramic substrate (1200mm ² ×0.8mm) 1unit	1.3		W
Total Dissipation	P_T	When mounted on ceramic substrate (1200mm ² ×0.8mm)	1.5		W
Channel Temperature	T_{ch}		150		°C
Storage Temperature	T_{stg}		-55 to +150		°C

This product is designed to "ESD immunity < 200V**", so please take care when handling.

* Machine Model

Stresses exceeding Maximum Ratings may damage the device. Maximum Ratings are stress ratings only. Functional operation above the Recommended Operating Conditions is not implied. Extended exposure to stresses above the Recommended Operating Conditions may affect device reliability.

Package Dimensions

unit : mm (typ)

7011A-001

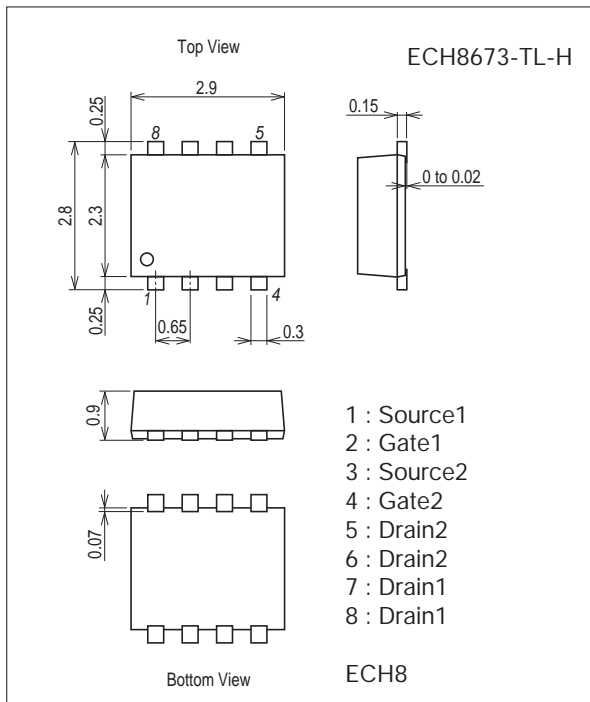

Product & Package Information

- Package : ECH8
- JEITA, JEDEC : -
- Minimum Packing Quantity : 3,000 pcs./reel

Packing Type : TL

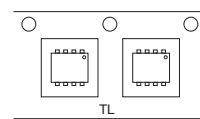

Marking

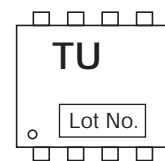

Electrical Connection

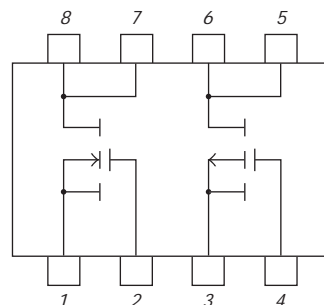

ECH8673

Electrical Characteristics at Ta=25°C

Parameter	Symbol	Conditions	Ratings			Unit
			min	typ	max	
[N-channel]						
Drain to Source Breakdown Voltage	V(BR)DSS	ID=1mA, VGS=0V	40			V
Zero-Gate Voltage Drain Current	IDSS	VDS=40V, VGS=0V			1	μA
Gate to Source Leakage Current	IGSS	VGS=±16V, VDS=0V			±10	μA
Cutoff Voltage	VGS(off)	VDS=10V, ID=1mA	1.2		2.6	V
Forward Transfer Admittance	yfs	VDS=10V, ID=2A		1.7		S
Static Drain to Source On-State Resistance	RDS(on)1	ID=2A, VGS=10V		65	85	mΩ
	RDS(on)2	ID=1A, VGS=4.5V		105	147	mΩ
	RDS(on)3	ID=1A, VGS=4V		125	175	mΩ
Input Capacitance	Ciss	VDS=20V, f=1MHz		230		pF
Output Capacitance	Coss			36		pF
Reverse Transfer Capacitance	Crss			9.9		pF
Turn-ON Delay Time	t _{d(on)}		See specified Test Circuit.		5.8	
Rise Time	t _r			10.6		ns
Turn-OFF Delay Time	t _{d(off)}			18.5		ns
Fall Time	t _f			9.8		ns
Total Gate Charge	Qg	VDS=20V, VGS=10V, ID=3.5A			5.3	
Gate to Source Charge	Qgs			1.1		nC
Gate to Drain "Miller" Charge	Qgd			1.1		nC
Diode Forward Voltage	VSD	IS=3.5A, VGS=0V		0.84	1.2	V
[P-channel]						
Drain to Source Breakdown Voltage	V(BR)DSS	ID=-1mA, VGS=0V	-40			V
Zero-Gate Voltage Drain Current	IDSS	VDS=-40V, VGS=0V			-1	μA
Gate to Source Leakage Current	IGSS	VGS=±16V, VDS=0V			±10	μA
Cutoff Voltage	VGS(off)	VDS=-10V, ID=-1mA	-1.2		-2.6	V
Forward Transfer Admittance	yfs	VDS=-10V, ID=-1.5A		2.7		S
Static Drain to Source On-State Resistance	RDS(on)1	ID=-1.5A, VGS=-10V		125	163	mΩ
	RDS(on)2	ID=-0.75A, VGS=-4.5V		190	266	mΩ
	RDS(on)3	ID=-0.75A, VGS=-4V		215	301	mΩ
Input Capacitance	Ciss	VDS=-20V, f=1MHz		198		pF
Output Capacitance	Coss			36		pF
Reverse Transfer Capacitance	Crss			8.1		pF
Turn-ON Delay Time	t _{d(on)}		See specified Test Circuit.		5.8	
Rise Time	t _r			10.3		ns
Turn-OFF Delay Time	t _{d(off)}			27.6		ns
Fall Time	t _f			17.3		ns
Total Gate Charge	Qg	VDS=-20V, VGS=-10V, ID=-2.5A			5.9	
Gate to Source Charge	Qgs			0.84		nC
Gate to Drain "Miller" Charge	Qgd			1.3		nC
Diode Forward Voltage	VSD	IS=-2.5A, VGS=0V		-0.87	-1.2	V

Switching Time Test Circuit

[N-channel]

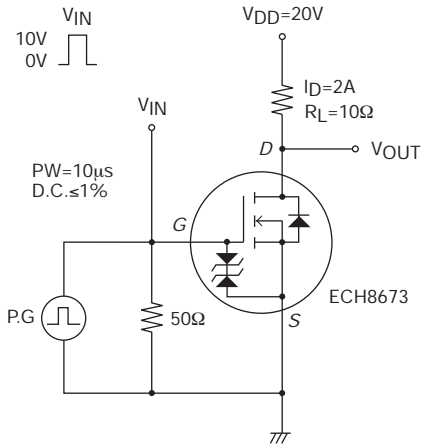

[P-channel]

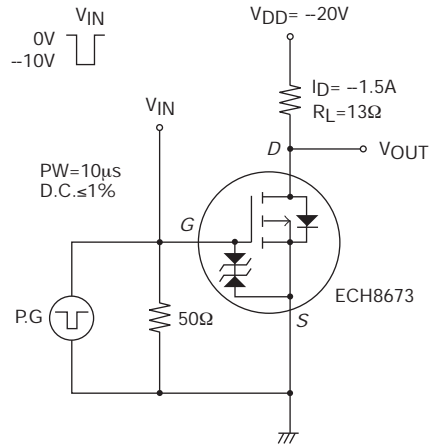

Ordering Information

Device	Package	Shipping	memo
ECH8673-TL-H	ECH8	3,000pcs./reel	Pb Free and Halogen Free

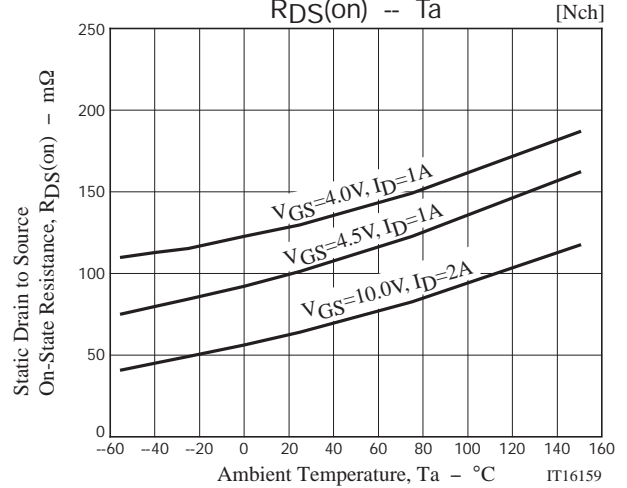
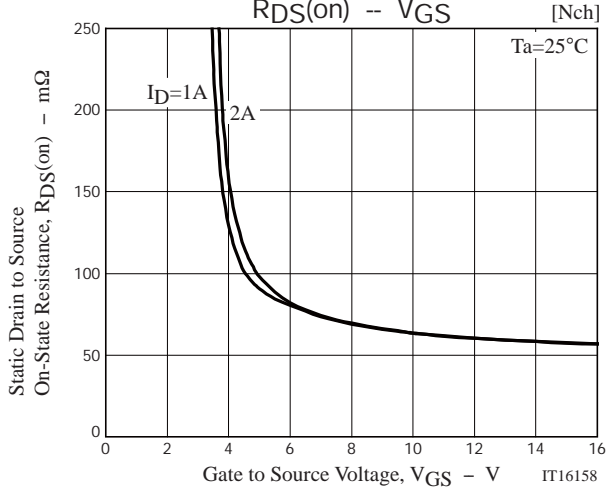
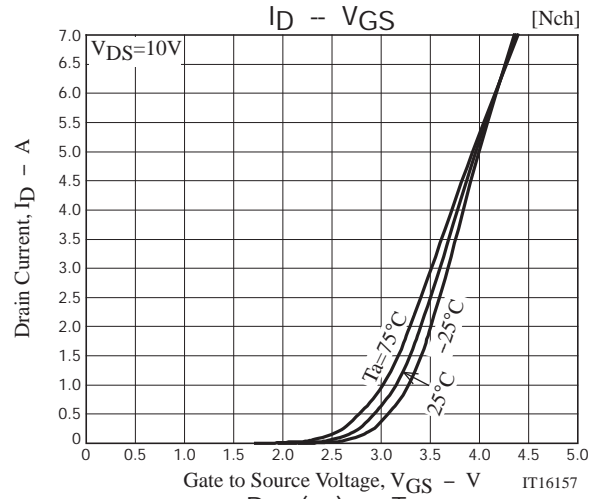
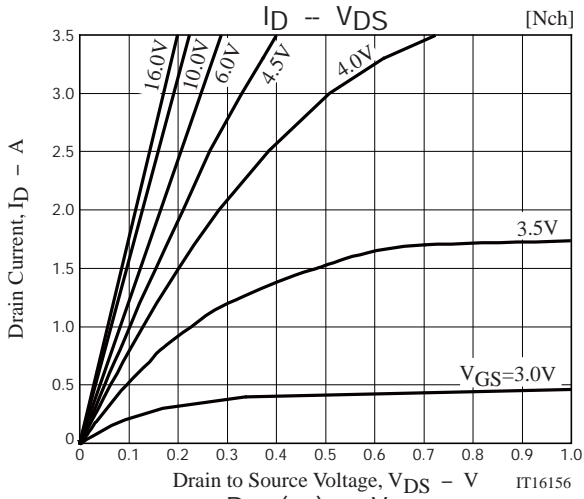

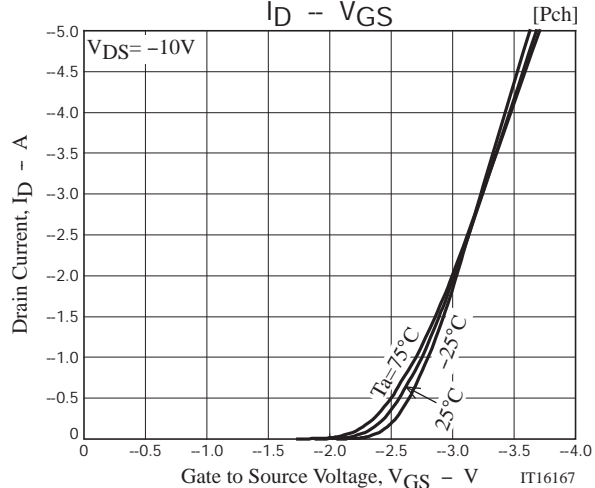
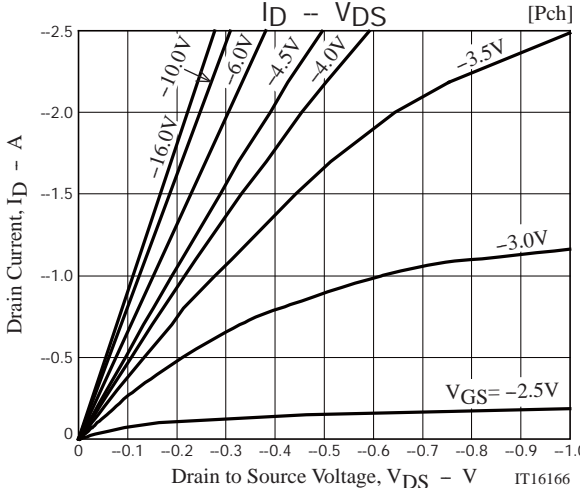
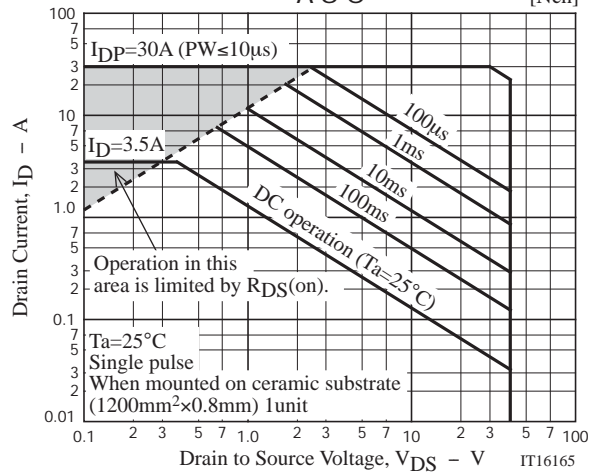
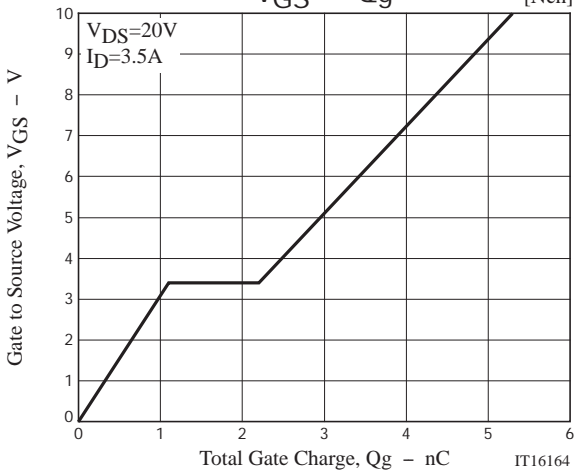
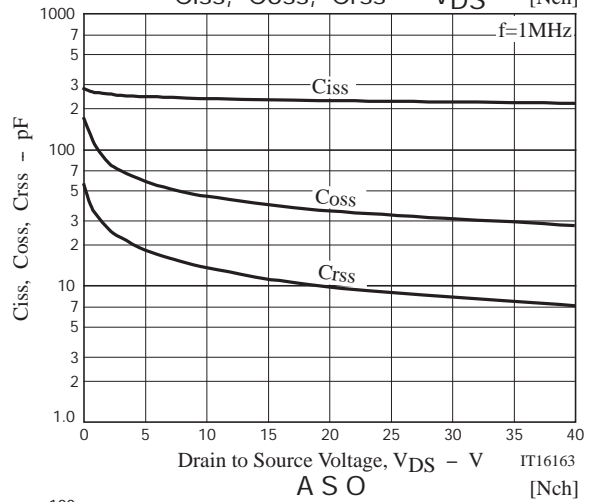
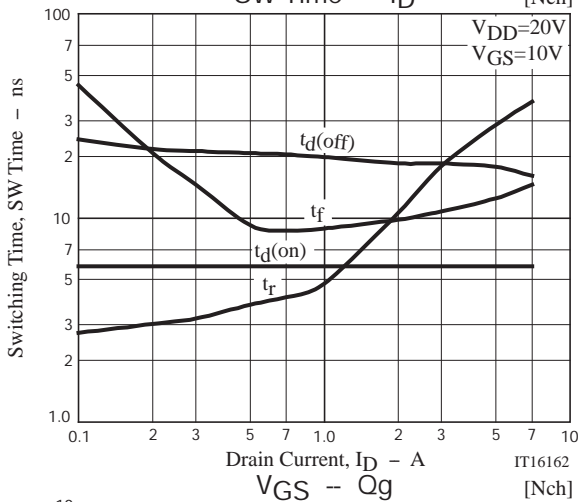
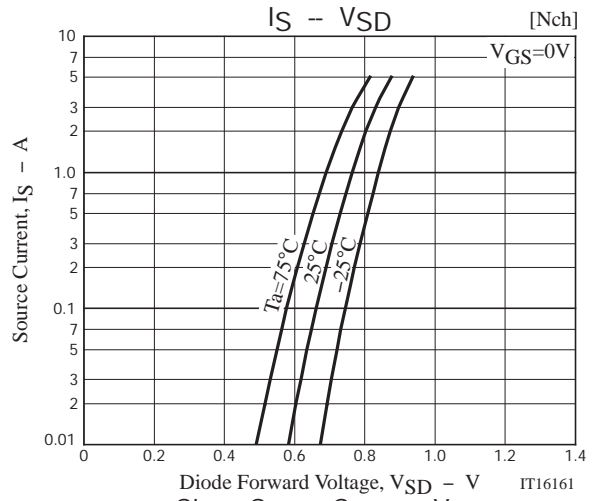
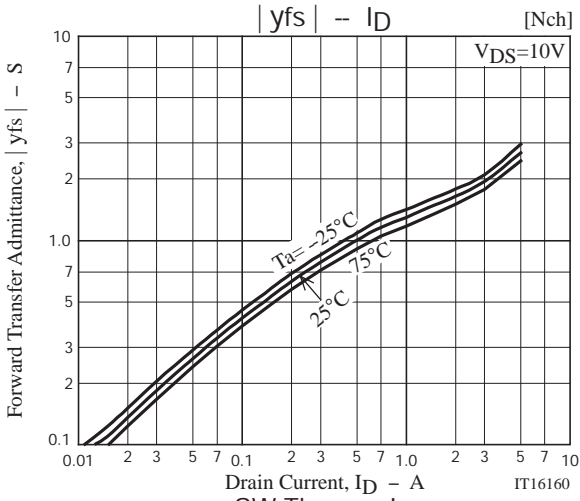

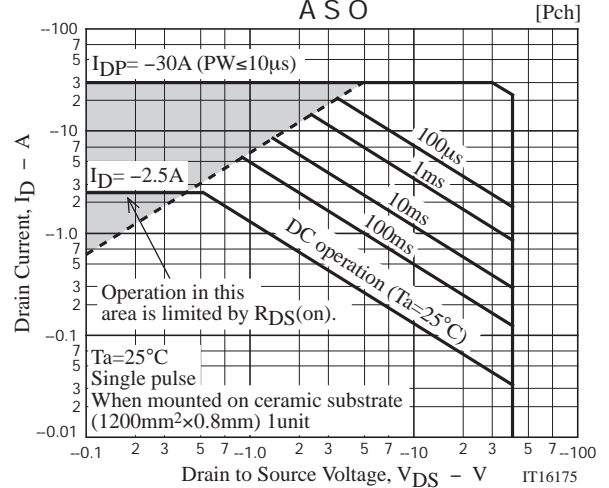
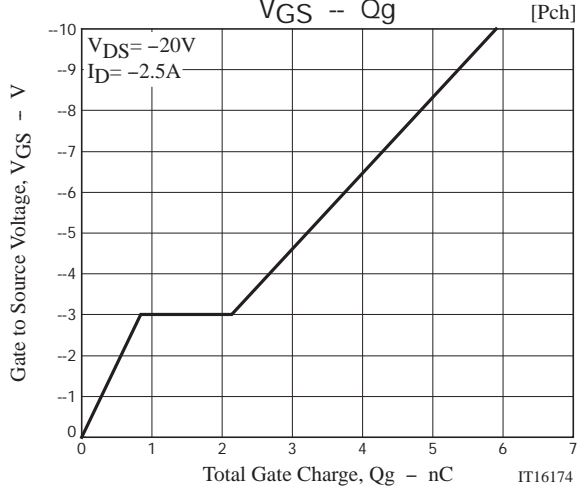
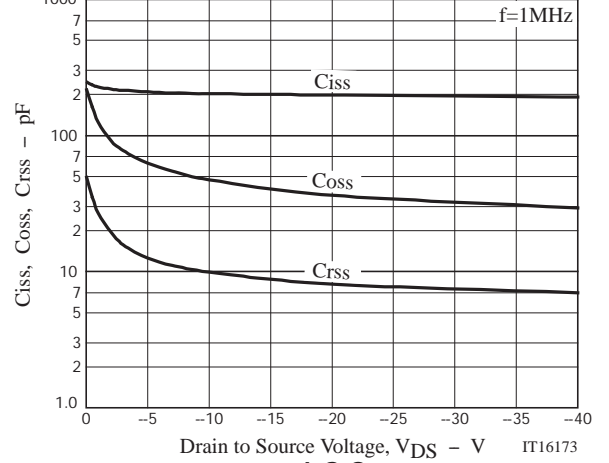
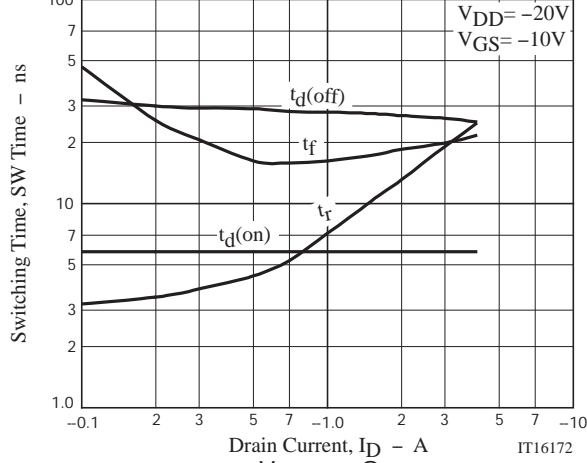
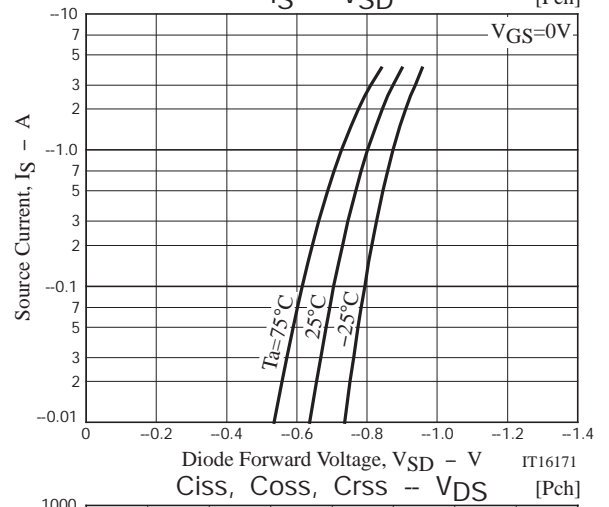
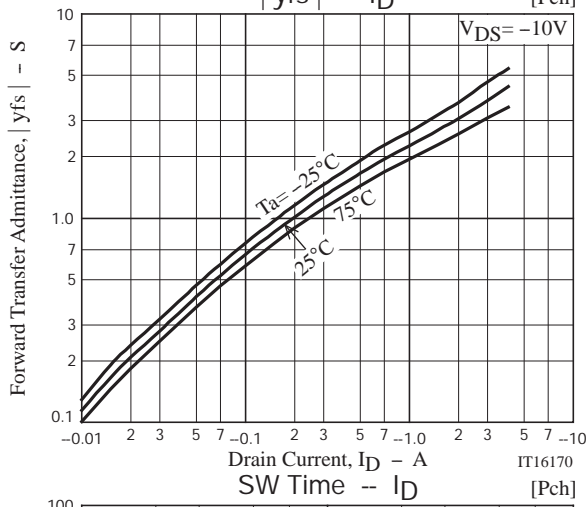
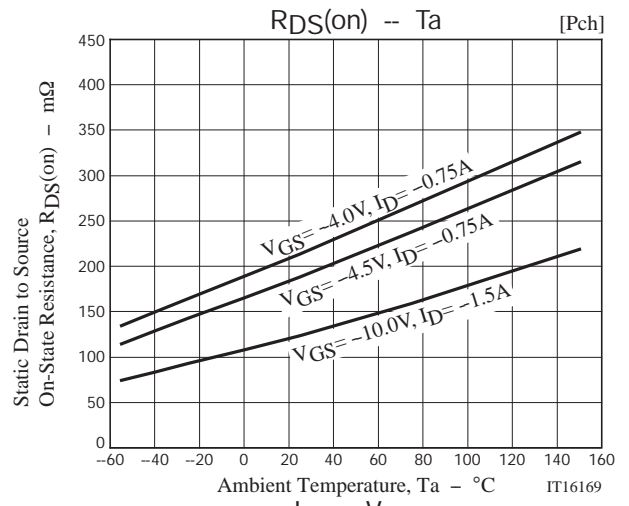
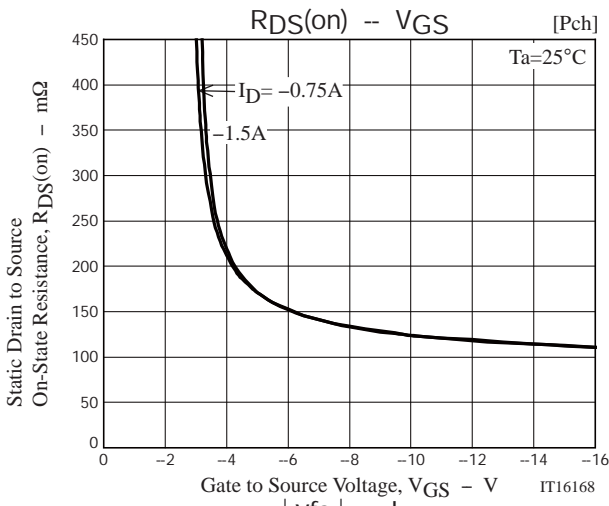

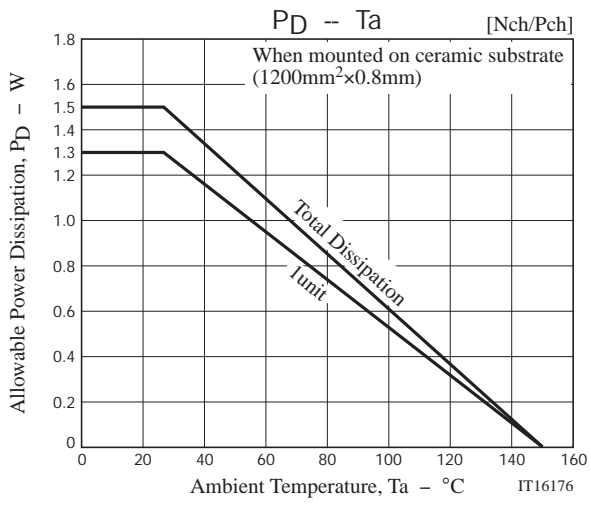

Outline Drawing
ECH8673-TL-H

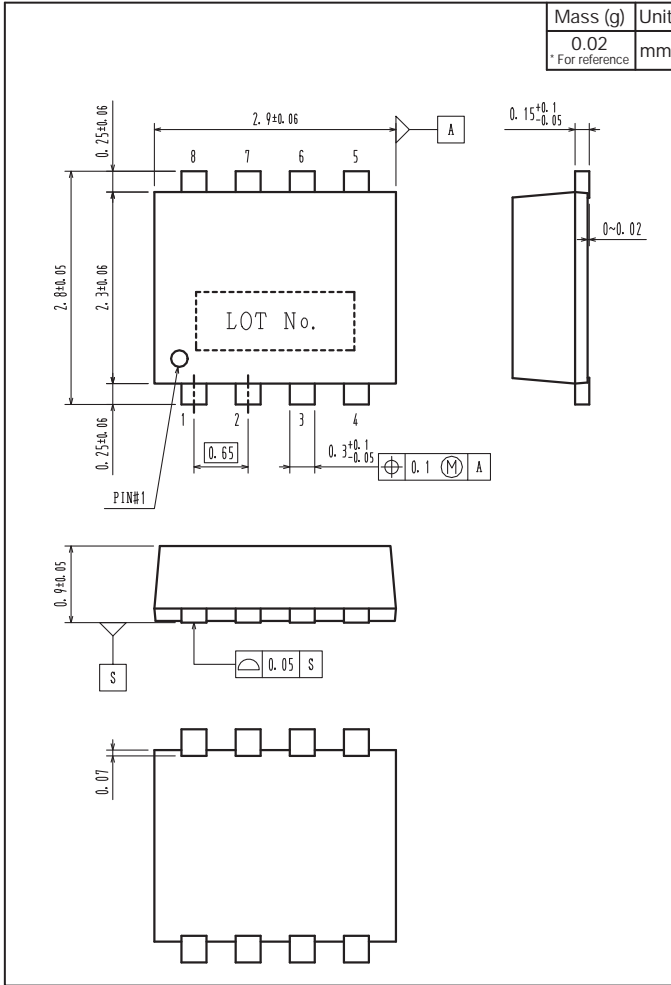

Land Pattern Example

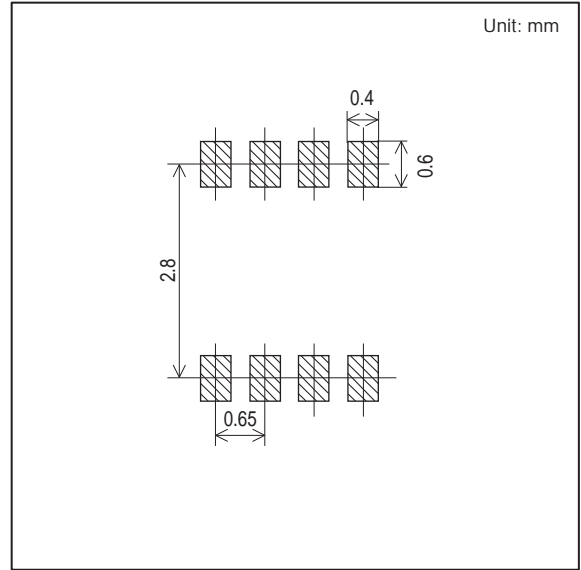

Note on usage : Since the ECH8673 is a MOSFET product, please avoid using this device in the vicinity of highly charged objects.

ON Semiconductor and the ON logo are registered trademarks of Semiconductor Components Industries, LLC (SCILLC). SCILLC owns the rights to a number of patents, trademarks, copyrights, trade secrets, and other intellectual property. A listing of SCILLC's product/patent coverage may be accessed at www.onsemi.com/site/pdf/Patent-Marking.pdf. SCILLC reserves the right to make changes without further notice to any products herein. SCILLC makes no warranty, representation or guarantee regarding the suitability of its products for any particular purpose, nor does SCILLC assume any liability arising out of the application or use of any product or circuit, and specifically disclaims any and all liability, including without limitation special, consequential or incidental damages. "Typical" parameters which may be provided in SCILLC data sheets and/or specifications can and do vary in different applications and actual performance may vary over time. All operating parameters, including "Typicals" must be validated for each customer application by customer's technical experts. SCILLC does not convey any license under its patent rights nor the rights of others. SCILLC products are not designed, intended, or authorized for use as components in systems intended for surgical implant into the body, or other applications intended to support or sustain life, or for any other application in which the failure of the SCILLC product could create a situation where personal injury or death may occur. Should Buyer purchase or use SCILLC products for any such unintended or unauthorized application, Buyer shall indemnify and hold SCILLC and its officers, employees, subsidiaries, affiliates, and distributors harmless against all claims, costs, damages, and expenses, and reasonable attorney fees arising out of, directly or indirectly, any claim of personal injury or death associated with such unintended or unauthorized use, even if such claim alleges that SCILLC was negligent regarding the design or manufacture of the part. SCILLC is an Equal Opportunity/Affirmative Action Employer. This literature is subject to all applicable copyright laws and is not for resale in any manner.