

# ES1DAF, ES1JAF

## Surface Mount Ultrafast Rectifier

### Features

- Fast Switching Speed – Maximum  $T_{rr}$  35 ns
- Ultra Thin Profile – Maximum Height of 1.0 mm
- Glass Passivated Junction
- UL Flammability 94V-0 Classification
- MSL 1
- Green Mold Compound
- These Devices are Pb-Free, Halogen Free and are RoHS Compliant

### Specifications

#### ABSOLUTE MAXIMUM RATINGS ( $T_A = 25^\circ\text{C}$ unless otherwise noted)

Symbol	Parameter	Value		Unit
		ES1DAF	ES1JAF	
$V_{RRM}$	Recurrent Peak Reverse Voltage	200	600	V
$V_{RMS}$	RMS Voltage	140	420	V
$V_R$	DC Blocking Voltage	200	600	V
$I_{F(AV)}$	Average Forward Current	1		A
$I_{FSM}$	Peak Forward Surge Current: 8.3 ms Single Half Sine-Wave Superimposed on Rated Load	30		A
$T_J$	Operating Junction Temperature Range	-55 to +150		$^\circ\text{C}$
$T_{STG}$	Storage Temperature Range	-55 to +150		$^\circ\text{C}$

Stresses exceeding those listed in the Maximum Ratings table may damage the device. If any of these limits are exceeded, device functionality should not be assumed, damage may occur and reliability may be affected.



**ON Semiconductor®**

[www.onsemi.com](http://www.onsemi.com)

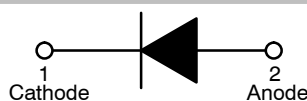

Ultrafast Rectifier

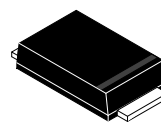

DO-214AD  
(SMAF)  
CASE 403AD

### MARKING DIAGRAMS



Band Indicates Cathode

\$Y = ON Semiconductor Logo  
&Z = Assembly Plant Code  
&3 = Data Code (Year & Week)  
ES1DAF = Specific Device Code

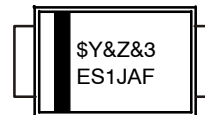

Band Indicates Cathode

\$Y = ON Semiconductor Logo  
&Z = Assembly Plant Code  
&3 = Data Code (Year & Week)  
ES1JAF = Specific Device Code

### ORDERING INFORMATION

See detailed ordering and shipping information on page 2 of this data sheet.

## ES1DAF, ES1JAF

### THERMAL CHARACTERISTICS ( $T_A = 25^\circ\text{C}$ unless otherwise noted)

Symbol	Characteristic	Value	Unit
$\Psi_{JL}$	Typical Thermal Characteristics, Junction-to-Lead (Note 1)	24	$^\circ\text{C/W}$
$R_{\theta JA}$	Typical Thermal Resistance, Junction-to-Ambient (Note 2)	150	$^\circ\text{C/W}$

1. Mounted on an FR4 PCB, single-sided copper, with 48 cm<sup>2</sup> copper pad area.
2. Mounted on an FR4 PCB, single-sided copper, mini pad.

### ELECTRICAL CHARACTERISTICS ( $T_A = 25^\circ\text{C}$ unless otherwise noted)

Symbol	Parameter	Conditions	Min	Typ	Max	Unit	
$V_F$	Forward Voltage	$I_F = 1\text{ A}$	ES1DAF	-	-	0.95	V
			ES1JAF	-	-	1.70	
$I_R$	Reverse Current	$V_R = V_{DC}$	-	-	1	$\mu\text{A}$	
$t_{rr}$	Reverse Recovery Time	$I_F = 0.5\text{ A}$ , $I_R = 1\text{ A}$ , $I_{rr} = 0.25\text{ A}$	-	-	34	ns	
$C_J$	Junction Capacitance	$V_R = 4\text{ V}$ , $f = 1\text{ MHz}$	-	15	-	pF	

Product parametric performance is indicated in the Electrical Characteristics for the listed test conditions, unless otherwise noted. Product performance may not be indicated by the Electrical Characteristics if operated under different conditions.

### ORDERING INFORMATION

Part Number	Top Mark	Package	Shipping <sup>†</sup>
ES1DAF	ES1DAF	DO-214AD (SMAF) (Pb-Free/Halogen Free)	10000 / Tape & Reel
ES1JAF	ES1JAF	DO-214AD (SMAF) (Pb-Free/Halogen Free)	10000 / Tape & Reel

<sup>†</sup>For information on tape and reel specifications, including part orientation and tape sizes, please refer to our Tape and Reel Packaging Specifications Brochure, BRD8011/D.

TYPICAL PERFORMANCE CHARACTERISTICS

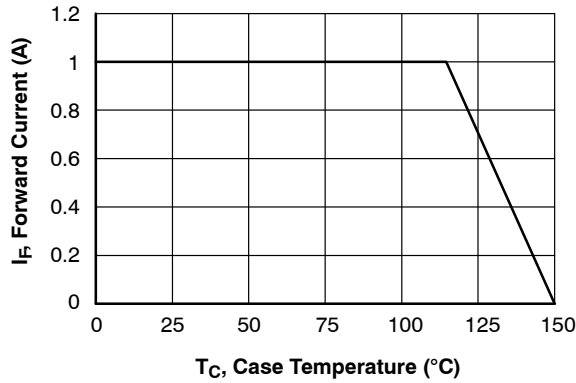

Figure 1. Forward Current Derating Curve

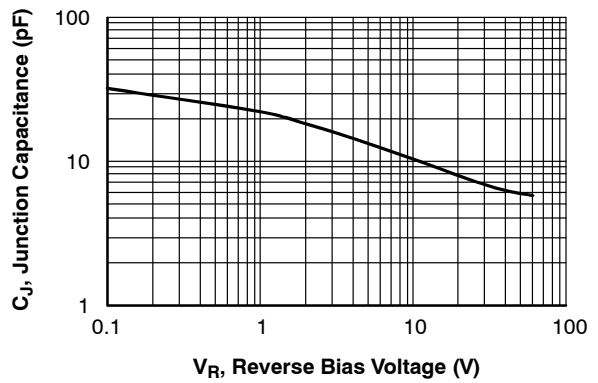

Figure 2. Typical Junction Capacitance

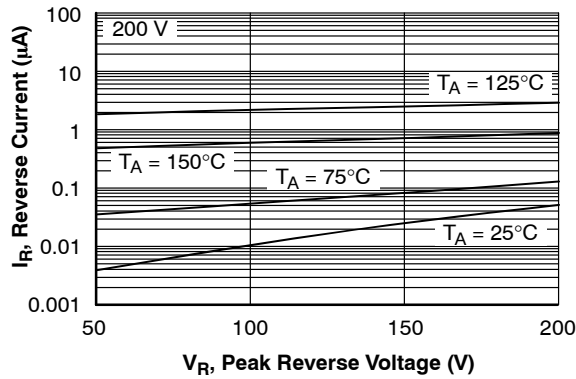

Figure 3. Typical Reverse Characteristics

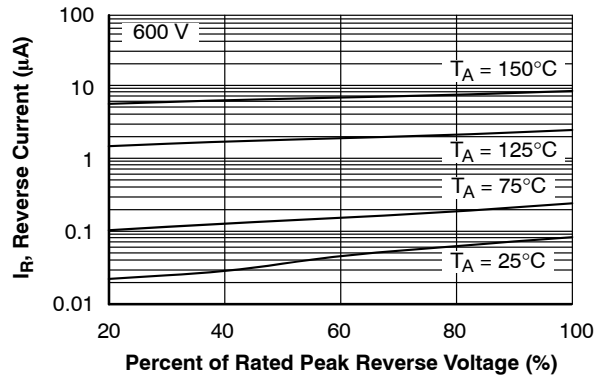

Figure 4. Typical Reverse Characteristics

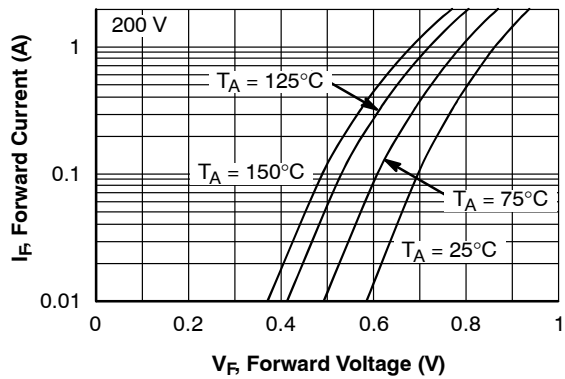

Figure 5. Typical Forward Characteristics

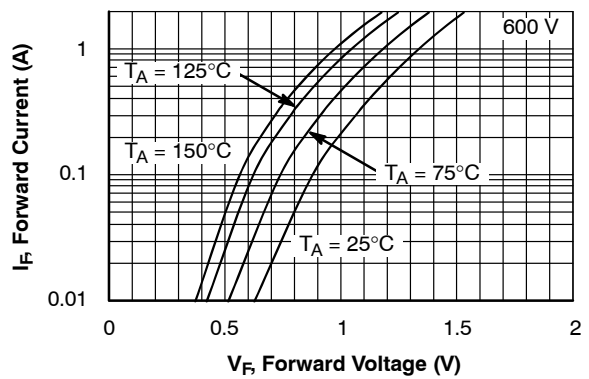
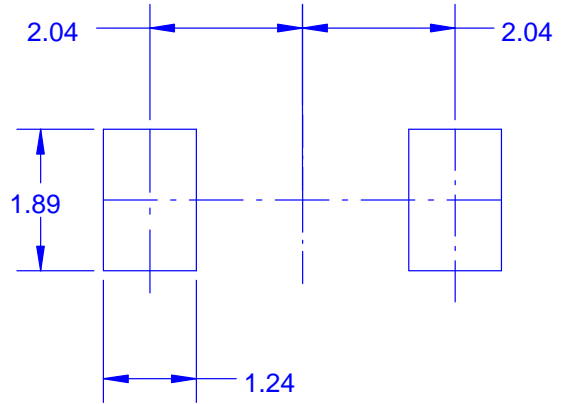
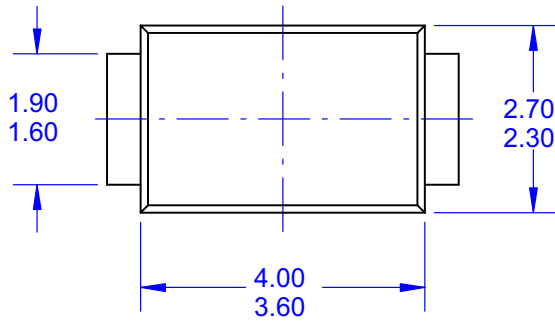

Figure 6. Typical Forward Characteristics

**SMA-FL**  
**CASE 403AD**  
**ISSUE O**

DATE 31 AUG 2016



**LAND PATTERN RECOMMENDATION**

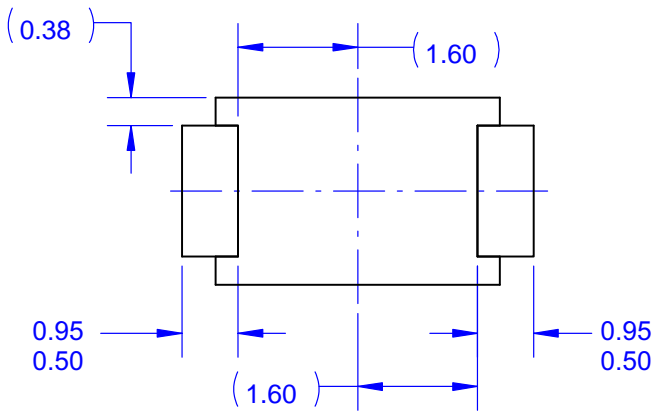
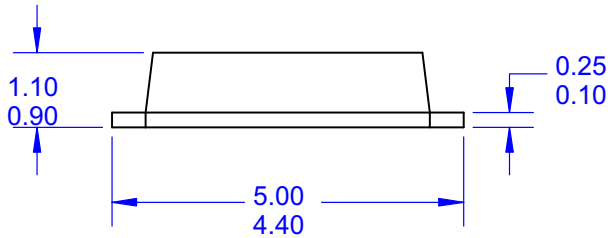

**NOTES:**

- A. THIS PACKAGE DOES NOT CONFORM TO ANY STANDARDS.
- B. ALL DIMENSIONS ARE IN MILLIMETERS.
- C. DIMENSIONS ARE EXCLUSIVE OF BURRS, MOLD FLASH AND TIE BAR PROTRUSIONS.

<b>DOCUMENT NUMBER:</b>	<b>98AON13439G</b>	Electronic versions are uncontrolled except when accessed directly from the Document Repository. Printed versions are uncontrolled except when stamped "CONTROLLED COPY" in red.
<b>STATUS:</b>	<b>ON SEMICONDUCTOR STANDARD</b>	
<b>NEW STANDARD:</b>		
<b>DESCRIPTION:</b>	<b>SMA-FL</b>	<b>PAGE 1 OF 2</b>



ON Semiconductor and  are trademarks of Semiconductor Components Industries, LLC dba ON Semiconductor or its subsidiaries in the United States and/or other countries. ON Semiconductor owns the rights to a number of patents, trademarks, copyrights, trade secrets, and other intellectual property. A listing of ON Semiconductor's product/patent coverage may be accessed at [www.onsemi.com/site/pdf/Patent-Marking.pdf](http://www.onsemi.com/site/pdf/Patent-Marking.pdf). ON Semiconductor reserves the right to make changes without further notice to any products herein. ON Semiconductor makes no warranty, representation or guarantee regarding the suitability of its products for any particular purpose, nor does ON Semiconductor assume any liability arising out of the application or use of any product or circuit, and specifically disclaims any and all liability, including without limitation special, consequential or incidental damages. Buyer is responsible for its products and applications using ON Semiconductor products, including compliance with all laws, regulations and safety requirements or standards, regardless of any support or applications information provided by ON Semiconductor. "Typical" parameters which may be provided in ON Semiconductor data sheets and/or specifications can and do vary in different applications and actual performance may vary over time. All operating parameters, including "Typicals" must be validated for each customer application by customer's technical experts. ON Semiconductor does not convey any license under its patent rights nor the rights of others. ON Semiconductor products are not designed, intended, or authorized for use as a critical component in life support systems or any FDA Class 3 medical devices or medical devices with a same or similar classification in a foreign jurisdiction or any devices intended for implantation in the human body. Should Buyer purchase or use ON Semiconductor products for any such unintended or unauthorized application, Buyer shall indemnify and hold ON Semiconductor and its officers, employees, subsidiaries, affiliates, and distributors harmless against all claims, costs, damages, and expenses, and reasonable attorney fees arising out of, directly or indirectly, any claim of personal injury or death associated with such unintended or unauthorized use, even if such claim alleges that ON Semiconductor was negligent regarding the design or manufacture of the part. ON Semiconductor is an Equal Opportunity/Affirmative Action Employer. This literature is subject to all applicable copyright laws and is not for resale in any manner.

## PUBLICATION ORDERING INFORMATION

### LITERATURE FULFILLMENT:

Literature Distribution Center for ON Semiconductor  
19521 E. 32nd Pkwy, Aurora, Colorado 80011 USA  
**Phone:** 303-675-2175 or 800-344-3860 Toll Free USA/Canada  
**Fax:** 303-675-2176 or 800-344-3867 Toll Free USA/Canada  
**Email:** [orderlit@onsemi.com](mailto:orderlit@onsemi.com)

**N. American Technical Support:** 800-282-9855 Toll Free  
USA/Canada  
**Europe, Middle East and Africa Technical Support:**  
Phone: 421 33 790 2910

**ON Semiconductor Website:** [www.onsemi.com](http://www.onsemi.com)

**Order Literature:** <http://www.onsemi.com/orderlit>

For additional information, please contact your local  
Sales Representative