



Is Now Part of



ON Semiconductor®

To learn more about ON Semiconductor, please visit our website at
www.onsemi.com

Please note: As part of the Fairchild Semiconductor integration, some of the Fairchild orderable part numbers will need to change in order to meet ON Semiconductor's system requirements. Since the ON Semiconductor product management systems do not have the ability to manage part nomenclature that utilizes an underscore (_), the underscore (_) in the Fairchild part numbers will be changed to a dash (-). This document may contain device numbers with an underscore (_). Please check the ON Semiconductor website to verify the updated device numbers. The most current and up-to-date ordering information can be found at www.onsemi.com. Please email any questions regarding the system integration to Fairchild_questions@onsemi.com.

ON Semiconductor and the ON Semiconductor logo are trademarks of Semiconductor Components Industries, LLC dba ON Semiconductor or its subsidiaries in the United States and/or other countries. ON Semiconductor owns the rights to a number of patents, trademarks, copyrights, trade secrets, and other intellectual property. A listing of ON Semiconductor's product/patent coverage may be accessed at www.onsemi.com/site/pdf/Patent-Marking.pdf. ON Semiconductor reserves the right to make changes without further notice to any products herein. ON Semiconductor makes no warranty, representation or guarantee regarding the suitability of its products for any particular purpose, nor does ON Semiconductor assume any liability arising out of the application or use of any product or circuit, and specifically disclaims any and all liability, including without limitation special, consequential or incidental damages. Buyer is responsible for its products and applications using ON Semiconductor products, including compliance with all laws, regulations and safety requirements or standards, regardless of any support or applications information provided by ON Semiconductor. "Typical" parameters which may be provided in ON Semiconductor data sheets and/or specifications can and do vary in different applications and actual performance may vary over time. All operating parameters, including "Typicals" must be validated for each customer application by customer's technical experts. ON Semiconductor does not convey any license under its patent rights nor the rights of others. ON Semiconductor products are not designed, intended, or authorized for use as a critical component in life support systems or any FDA Class 3 medical devices or medical devices with a same or similar classification in a foreign jurisdiction or any devices intended for implantation in the human body. Should Buyer purchase or use ON Semiconductor products for any such unintended or unauthorized application, Buyer shall indemnify and hold ON Semiconductor and its officers, employees, subsidiaries, affiliates, and distributors harmless against all claims, costs, damages, and expenses, and reasonable attorney fees arising out of, directly or indirectly, any claim of personal injury or death associated with such unintended or unauthorized use, even if such claim alleges that ON Semiconductor was negligent regarding the design or manufacture of the part. ON Semiconductor is an Equal Opportunity/Affirmative Action Employer. This literature is subject to all applicable copyright laws and is not for resale in any manner.



FAN102

Primary-Side-Control PWM Controller

Features

- Constant-Voltage (CV) and Constant-Current (CC) Control without Secondary-Feedback Circuitry
- Green Mode: Frequency Reduction at Light Load
- Fixed PWM Frequency at 42 kHz with Frequency Hopping to Reduce EMI
- Cable Voltage Drop Compensation in CV Mode
- Low Startup Current: 10 μ A
- Low Operating Current: 3.5 mA
- Peak-Current-Mode Control in CV Mode
- Cycle-by-Cycle Current Limiting
- V_{DD} Over-Voltage Protection with Auto-Restart
- V_{DD} Under-Voltage Lockout (UVLO)
- Gate Output Maximum Voltage Clamped at 18 V
- Fixed Over-Temperature Protection with Auto-Restart
- SOP-8 Package Available

Applications

- Battery Chargers for Cellular Phones, Cordless Phones, PDA, Digital Cameras, Power Tools
- Replaces Linear Transformer and RCC SMPS
- Offline High Brightness (HB) LED Drivers

Description

The primary-side PWM controller significantly simplifies power supply design that requires CV and CC regulation capabilities. The FAN102 controls the output voltage and current precisely with the information in the primary side of the power supply, not only removing the output current sensing loss, but eliminating all secondary feedback circuitry.

The green-mode function with a low startup current (10 μ A) maximizes the light-load efficiency so the power supply can meet stringent standby power regulations.

Compared with a conventional secondary-side regulation approach, the FAN102 can reduce total cost, component count, size, and weight; while simultaneously increasing efficiency, productivity, and system reliability.

A typical output CV/CC characteristic envelope is shown in Figure 1.

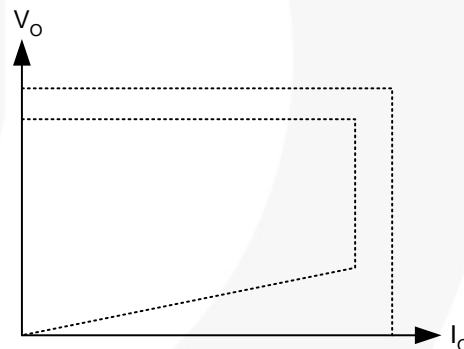

Figure 1. Typical Output V-I Characteristic

Ordering Information

Part Number	Operating Temperature Range	Package	Packing Method
FAN102MY	-40°C to +105°C	8-Lead, Small Outline Package (SOP-8)	Tape & Reel

For Fairchild's definition of Eco Status, please visit: http://www.fairchildsemi.com/company/green/rohs_green.html.

Application Diagram

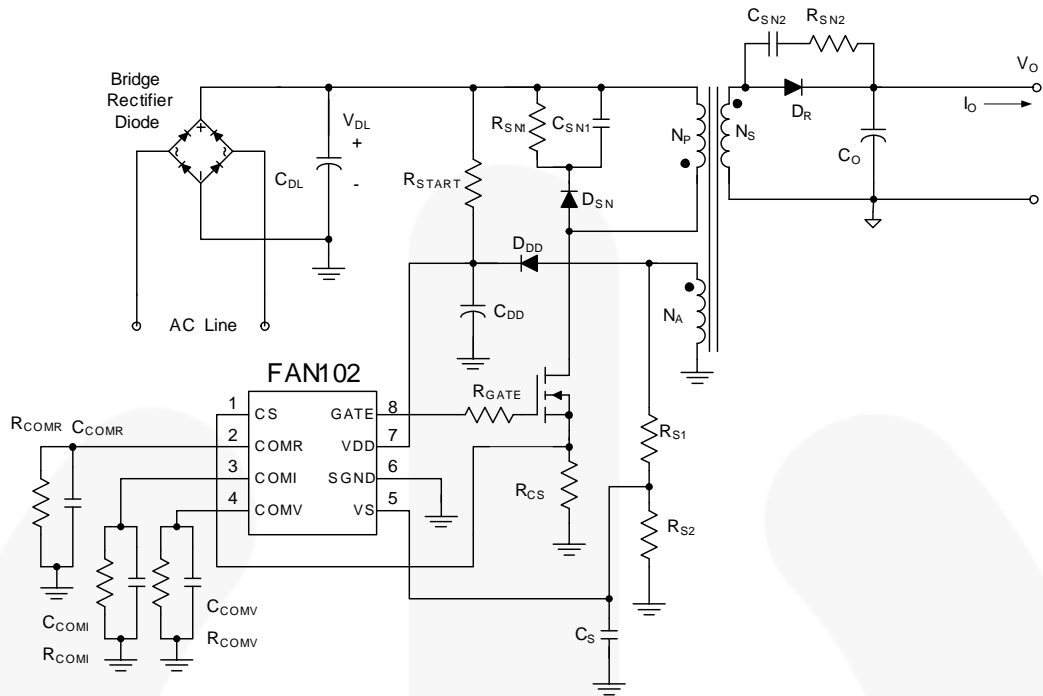

Figure 2. Typical Application

Internal Block Diagram

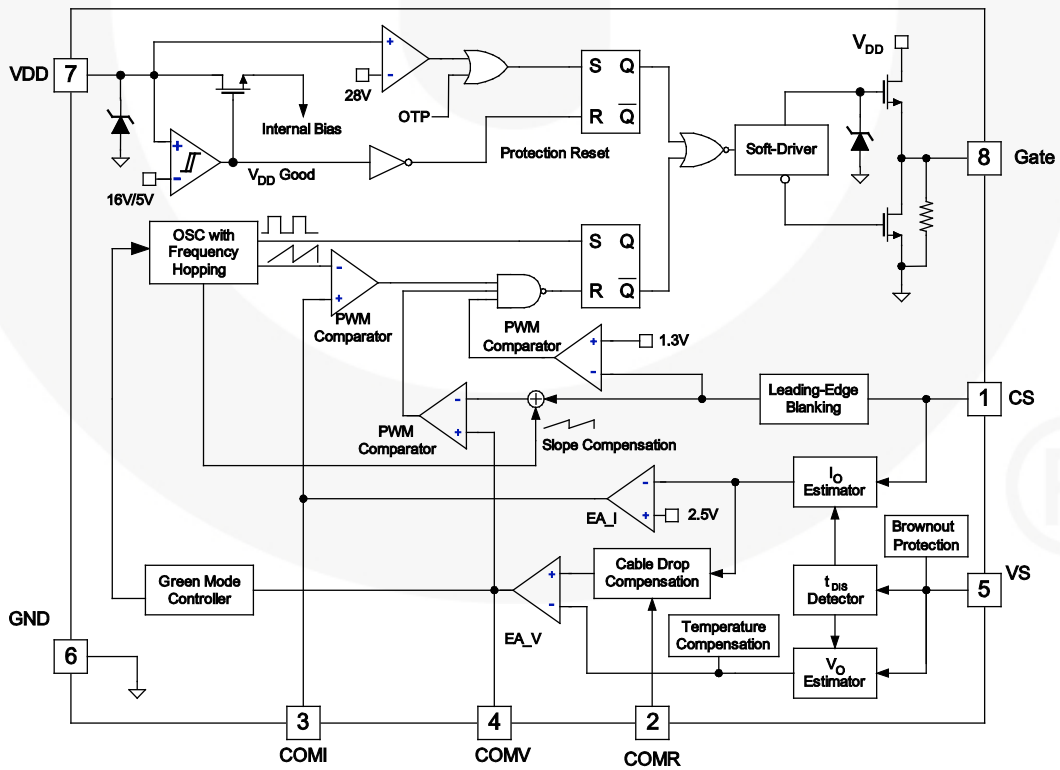
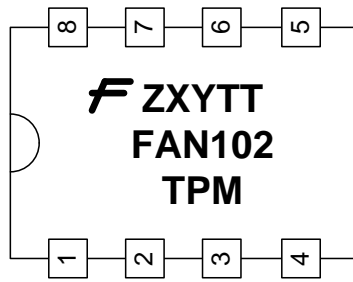

Figure 3. Functional Block Diagram

Marking Information



F- Fairchild Logo
 Z- Plant Code
 X- 1-Digit Year Code
 Y- 1-Digit Week Code
 TT- 2-Digit Die Run Code
 T- Package Type (M=SOP)
 P- Z: Pb Free, Y: Green Package
 M- Manufacture Flow Code

Figure 4. Top Mark

Pin Configuration

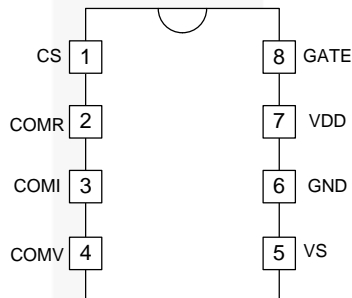

Figure 5. Pin Configuration

Pin Definitions

Pin #	Name	Description
1	CS	Current Sense. This pin connects a current-sense resistor to sense the MOSFET current for peak-current-mode control in CV mode and provides for output-current regulation in CC mode.
2	COMR	Cable Compensation. This pin is connects a capacitor between COMR and GND for compensation voltage drop due to output cable loss in CV mode.
3	COMI	Constant Current Loop Compensation. This pin is connects a capacitor and a resistor between COMI and GND for compensation current loop gain.
4	COMV	Constant Voltage Loop Compensation. This pin is connects a capacitor and a resistor between COMV and GND for compensation voltage loop gain.
5	VS	Voltage Sense. This pin detects the output voltage information and discharges time base on voltage of auxiliary winding. This pin connects two divider resistors and one capacitor.
6	GND	Ground.
7	VDD	Power Supply. IC operating current and MOSFET driving current are supplied using this pin. This pin is connected to an external V_{DD} capacitor (typically 10 μ F). The threshold voltages for startup and turn-off are 16 V and 5 V, respectively.
8	GATE	PWM Signal Output. This pin outputs PWM signal and includes the internal totem-pole output driver to drive the external power MOSFET. The clamped gate output voltage is 18 V.

Absolute Maximum Ratings

Stresses exceeding the absolute maximum ratings may damage the device. The device may not function or be operable above the recommended operating conditions and stressing the parts to these levels is not recommended. In addition, extended exposure to stresses above the recommended operating conditions may affect device reliability. The absolute maximum ratings are stress ratings only.

Symbol	Parameter	Min.	Max.	Unit
V _{DD}	DC Supply Voltage ^(1,2)		30	V
V _{VS}	VS Pin Input Voltage	-0.3	7.0	V
V _{CS}	CS Pin Input Voltage	-0.3	7.0	V
V _{COMV}	Voltage Error Amplifier Output Voltage	-0.3	7.0	V
V _{COMI}	Voltage Error Amplifier Output Voltage	-0.3	7.0	V
P _D	Power Dissipation (T _A < 50°C)		660	mW
θ _{JA}	Thermal Resistance (Junction-to-Air)		150	°C /W
θ _{JC}	Thermal Resistance (Junction-to-Case)		39	°C /W
T _J	Operating Junction Temperature		+150	°C
T _{STG}	Storage Temperature Range	-55	+150	°C
T _L	Lead Temperature (Wave Soldering or IR, 10 Seconds)		+260	°C
ESD	Electrostatic Discharge Capability, Human Body Model, JEDEC- JESD22_A114		4.5	kV
	Electrostatic Discharge Capability, Charged Device Model, JEDEC- JESD22_C101		1250	V

Notes:

1. Stresses beyond those listed under Absolute Maximum Ratings may cause permanent damage to the device.
2. All voltage values, except differential voltages, are given with respect to GND pin.

Recommended Operating Conditions

The Recommended Operating Conditions table defines the conditions for actual device operation. Recommended operating conditions are specified to ensure optimal performance to the datasheet specifications. Fairchild does not recommend exceeding them or designing to Absolute Maximum Ratings.

Symbol	Parameter	Conditions	Min.	Typ.	Max.	Unit
T _A	Operating Ambient Temperature		-40		+105	°C

Electrical Characteristics

$V_{DD}=15V$ and $T_A=25^{\circ}C$ unless otherwise specified.

Symbol	Parameter	Conditions	Min.	Typ.	Max.	Units	
V_{DD} Section							
V_{OP}	Continuously Operating Voltage				25	V	
V_{DD-ON}	Turn-On Threshold Voltage		15	16	17	V	
V_{DD-OFF}	Turn-Off Threshold Voltage		4.5	5.0	5.5	V	
I_{DD-OP}	Operating Current	$V_{DD}=20V$, $f_s=f_{OSC}$, $V_{VS}=2V$, $V_{CS}=3V$, $C_L=1nF$		3.5	5.0	mA	
I_{DD-ST}	Startup Current	$0 < V_{DD} < V_{DD-ON}$ - 0.16 V	0	1.6	10.0	μA	
$I_{DD-GREEN}$	Green-Mode Operating Supply Current	$V_{DD}=20V$, $V_{VS}=2.7V$ $f_s=f_{OSC-N-MIN}$, $V_{CS}=0V$ $C_L=1nF$, $V_{COMV}=0V$		1	2	mA	
V_{DD-OVP}	V_{DD} Over-Voltage Protection Level	$V_{CS}=3V$, $V_{VS}=2.3V$	27	28	29	V	
$t_{D-VDDOVP}$	V_{DD} Over-Voltage Protection Debounce Time	$f_s=f_{OSC}$, $V_{VS}=2.3V$	100	250	400	μs	
Oscillator Section							
f_{OSC}	Frequency	Center Frequency	$T_A=25^{\circ}C$	39	42	45	KHz
		Frequency Hopping Range	$T_A=25^{\circ}C$	± 1.8	± 2.6	± 3.6	
t_{FHR}	Frequency Hopping Period	$T_A=25^{\circ}C$		3		ms	
$f_{OSC-N-MIN}$	Minimum Frequency at No Load	$V_{VS}=2.7V$, $V_{COMV}=0V$		550		Hz	
$f_{OSC-CM-MIN}$	Minimum Frequency at CCM	$V_{VS}=2.3V$, $V_{CS}=0.5V$		20		KHz	
f_{DV}	Frequency Variation vs. V_{DD} Deviation	$V_{DD}=10V$ to $25V$			5	%	
f_{DT}	Frequency Variation vs. Temperature Deviation	$T_A=-40^{\circ}C$ to $+105^{\circ}C$			15	%	
Voltage-Sense Section							
I_{VS-UVP}	Sink Current for Brownout Protection	$R_{VS}=20K\Omega$		180		μA	
I_{tc}	IC Compensation Bias Current			9.5		μA	
$V_{BIAS-COMV}$	Adaptive Bias Voltage Dominated by V_{COMV}	$V_{COMV}=0V$, $T_A=25^{\circ}C$, $R_{VS}=20K\Omega$		1.4		V	
Current-Sense Section							
t_{PD}	Propagation Delay to GATE Output			100	200	ns	
t_{MIN-N}	Minimum On Time at No Load	$V_{VS}=-0.8V$, $R_S=2K\Omega$, $V_{COMV}=1V$		1100		ns	
t_{MINCC}	Minimum On Time in CC Mode	$V_{VS}=0V$, $V_{COMV}=2V$		400		ns	
V_{TH}	Threshold Voltage for Current Limit			1.3		V	

Continued on the following page...

Electrical Characteristics

$V_{DD}=15V$ and $T_A=25^{\circ}C$ unless otherwise specified.

Symbol	Parameter	Conditions	Min.	Typ.	Max.	Units
Voltage-Error-Amplifier Section						
V_{VR}	Reference Voltage		2.475	2.500	2.525	V
V_N	Green Mode Starting Voltage on COMV Pin	$f_S=f_{OSC}-2$ KHz, $V_{VS}=2.3$ V		2.8		V
V_G	Green Mode Ending Voltage on COMV Pin	$f_S=1$ KHz		0.8		V
I_{V-SINK}	Output Sink Current	$V_{VS}=3$ V, $V_{COMV}=2.5$ V		90		μA
$I_{V-SOURCE}$	Output Source Current	$V_{VS}=2$ V, $V_{COMV}=2.5$ V		90		μA
V_{V-HGH}	Output High Voltage	$V_{VS}=2.3$ V	4.5			V
Current-Error-Amplifier Section						
V_{IR}	Reference Voltage		2.475	2.500	2.525	V
I_{I-SINK}	Output Sink Current	$V_{CS}=3$ V, $V_{COMI}=2.5$ V		55		μA
$I_{I-SOURCE}$	Output Source Current	$V_{CS}=0$ V, $V_{COMI}=2.5$ V		55		μA
V_{I-HGH}	Output High Voltage	$V_{CS}=0$ V	4.5			V
Cable Compensation Section						
V_{COMR}	Variation Test Voltage on COMR Pin for Cable Compensation	$R_{COMR}=100$ K Ω		0.735		V
Gate Section						
DCY_{MAX}	Maximum Duty Cycle			75		%
V_{OL}	Output Voltage LOW	$V_{DD}=20$ V, $I_O=10$ mA			1.5	V
V_{OH}	Output Voltage HIGH	$V_{DD}=8$ V, $I_O=1$ mA	5			V
V_{OH_MIN}	Output Voltage HIGH	$V_{DD}=5.5$ V, $I_O=1$ mA	4			V
t_r	Rising Time	$V_{DD}=20$ V, $C_L=1$ nF		200	300	ns
t_f	Falling Time	$V_{DD}=20$ V, $C_L=1$ nF		80	150	ns
V_{CLAMP}	Output Clamp Voltage	$V_{DD}=25$ V		15	18	V
Over-Temperature-Protection Section						
T_{OTP}	Threshold Temperature for OTP ⁽³⁾			+140		$^{\circ}C$

Note:

- When over-temperature protection is activated, the power system enters auto restart mode and output is disabled.

Typical Performance Characteristics

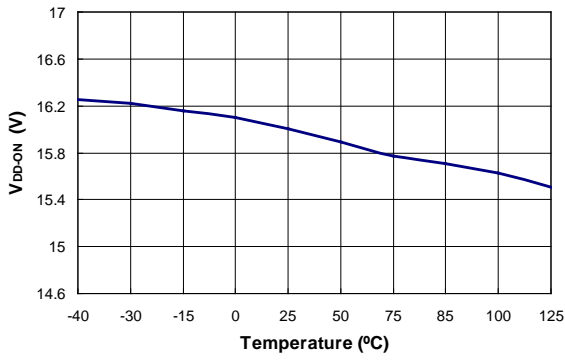

Figure 6. Turn-On Threshold Voltage (V_{DD-ON}) vs. Temperature

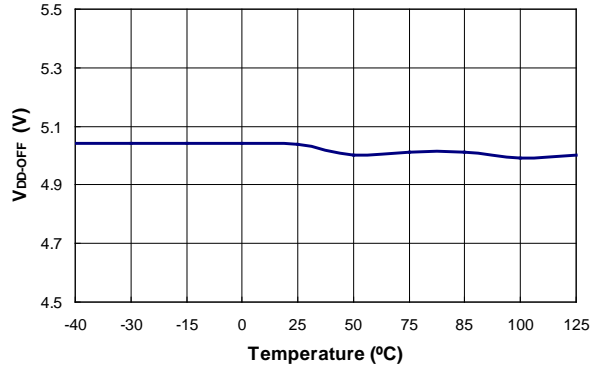

Figure 7. Turn-Off Threshold Voltage (V_{DD-OFF}) vs. Temperature

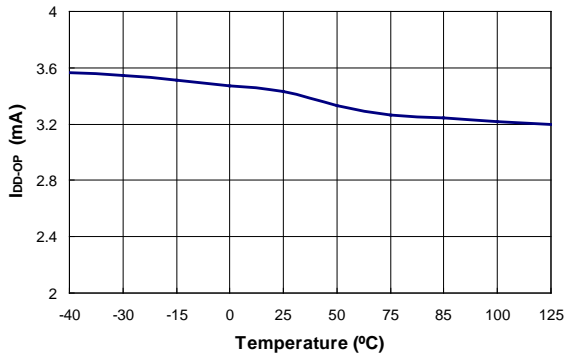

Figure 8. Operating Current (I_{DD-OP}) vs. Temperature

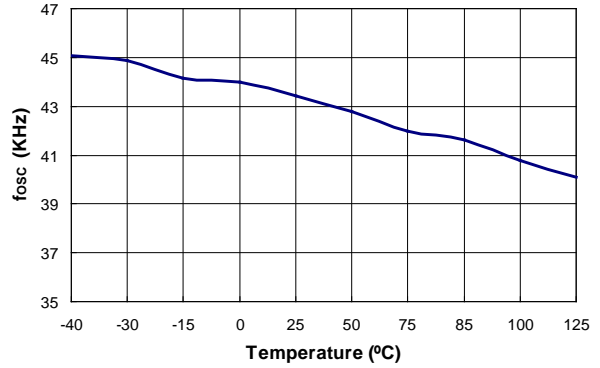

Figure 9. Center Frequency (f_{osc}) vs. Temperature

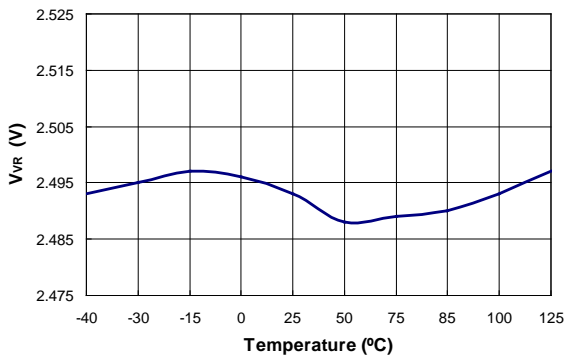

Figure 10. Reference Voltage (V_{VR}) vs. Temperature

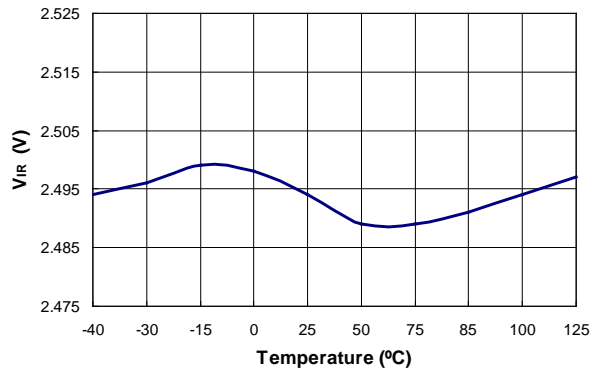

Figure 11. Reference Voltage (V_{IR}) vs. Temperature

Typical Performance Characteristics

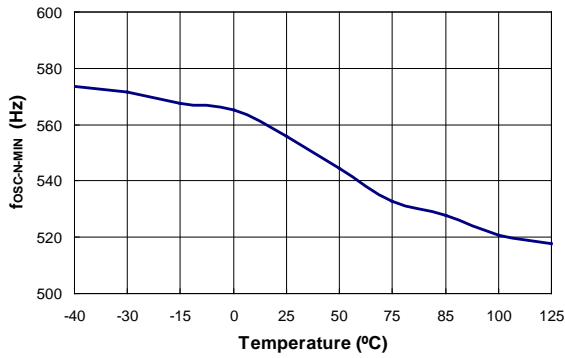

Figure 12. Minimum Frequency at No Load (f_{OSC-N-MIN}) vs. Temperature

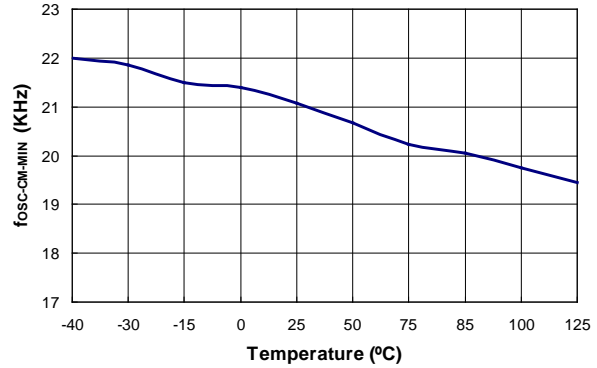

Figure 13. Minimum Frequency at CCM (f_{OSC-CM-MIN}) vs. Temperature

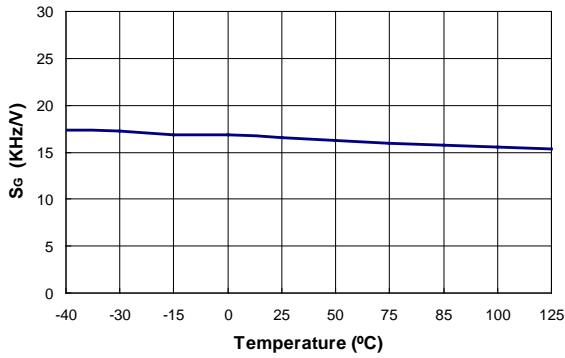

Figure 14. Green Mode Frequency Decreasing Rate (S_G) vs. Temperature

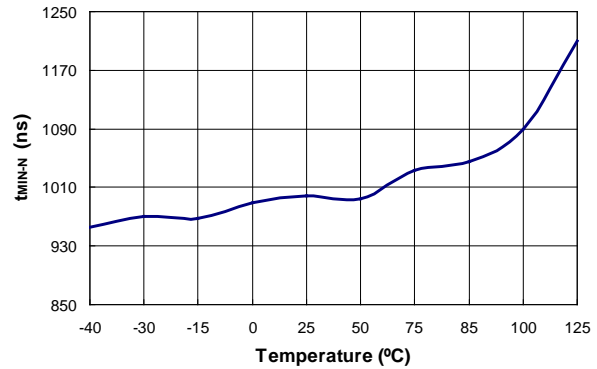

Figure 15. Minimum On Time at No Load (t_{MIN-N}) vs. Temperature

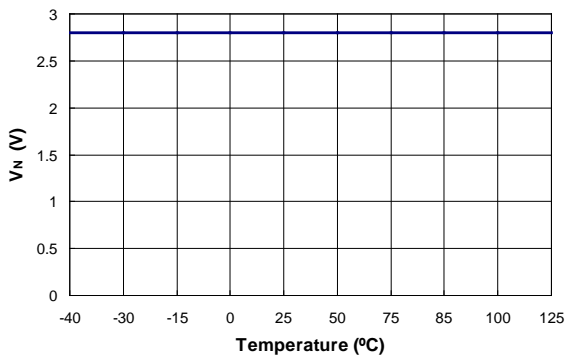

Figure 16. Green Mode Starting Voltage on COMV Pin (V_N) vs. Temperature

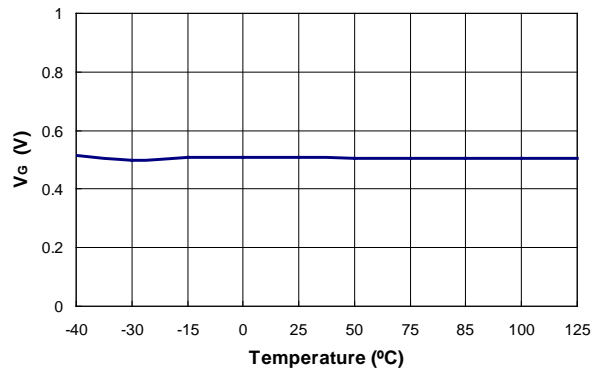

Figure 17. Green Mode Ending Voltage on COMV Pin (V_G) vs. Temperature

Typical Performance Characteristics

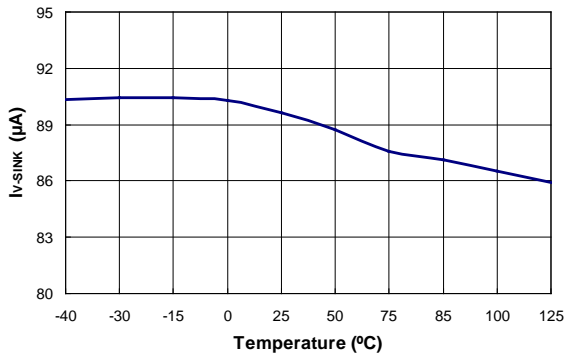

Figure 18. Output Sink Current (I_{v-SINK}) vs. Temperature

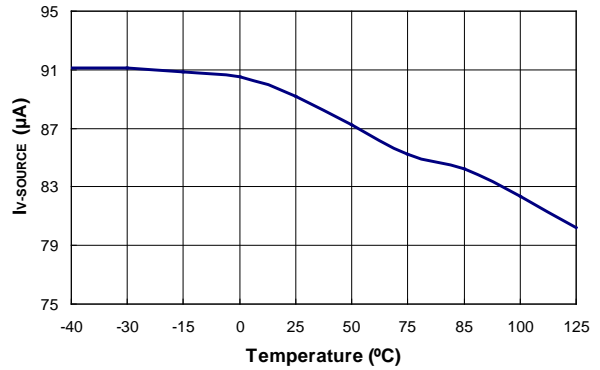

Figure 19. Output Source Current ($I_{v-SOURCE}$) vs. Temperature

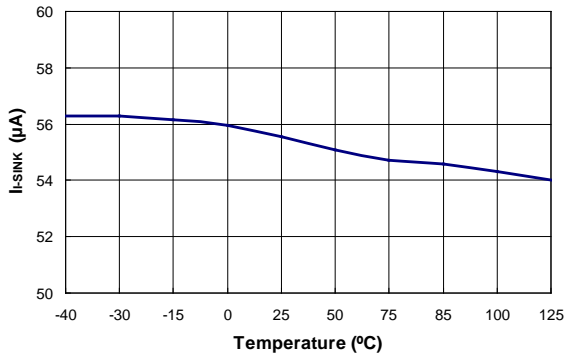

Figure 20. Output Sink Current (I_{i-SINK}) vs. Temperature

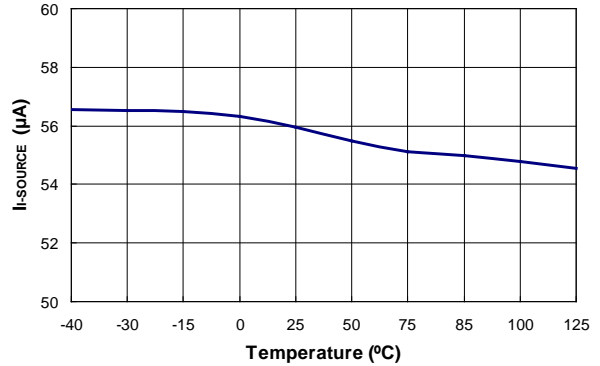

Figure 21. Output Source Current ($I_{i-SOURCE}$) vs. Temperature

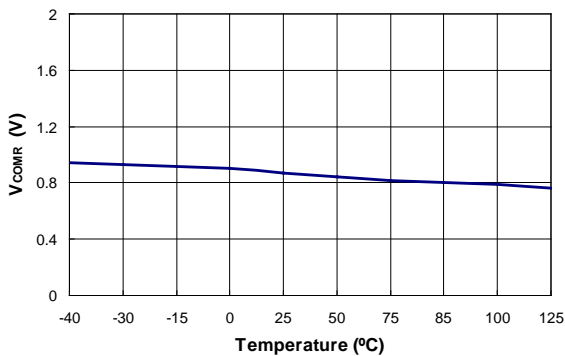

Figure 22. Variation Test Voltage on COMR Pin for Cable Compensation (V_{COMR}) vs. Temperature

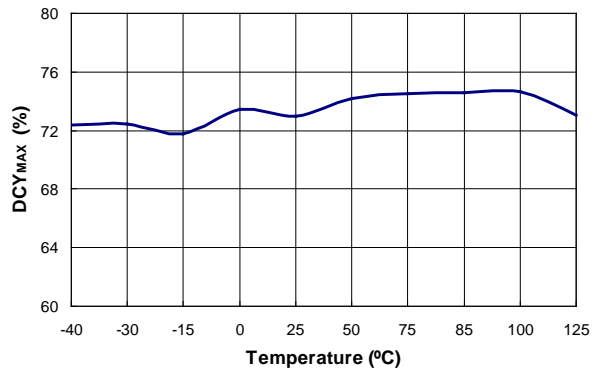

Figure 23. Maximum Duty Cycle (DCY_{MAX}) vs. Temperature

Functional Description

Figure 24 shows the basic circuit diagram of primary-side regulated flyback converter with typical waveforms shown in Figure 25. Generally, discontinuous conduction mode (DCM) operation is preferred for primary-side regulation since it allows better output regulation. The operation principles of DCM flyback converter are as follows:

During the MOSFET ON time (t_{ON}), input voltage (V_{DL}) is applied across the primary-side inductor (L_m). Then MOSFET current (I_{ds}) increases linearly from zero to the peak value (I_{pk}). During this time, the energy is drawn from the input and stored in the inductor.

When the MOSFET is turned off, the energy stored in the inductor forces the rectifier diode (D) to turn on. While the diode is conducting, the output voltage (V_o), together with diode forward voltage drop (V_F), are applied across the secondary-side inductor ($L_m \times N_s^2 / N_p^2$) and the diode current (I_D) decreases linearly from the peak value ($I_{pk} \times N_p / N_s$) to zero. At the end of inductor current discharge time (t_{DIS}), all the energy stored in the inductor has been delivered to the output.

When the diode current reaches zero, the transformer auxiliary winding voltage (V_w) begins to oscillate by the resonance between the primary-side inductor (L_m) and the effective capacitor loaded across MOSFET.

During the inductor current discharge time, the sum of output voltage and diode forward voltage drop is reflected to the auxiliary winding side as $(V_o + V_F) \times N_A / N_s$. Since the diode forward voltage drop decreases as current decreases, the auxiliary winding voltage reflects the output voltage best at the end of diode conduction time where the diode current diminishes to zero. By sampling the winding voltage at the end of the diode conduction time, the output voltage information can be obtained. The internal error amplifier for output voltage regulation (EA_V) compares the sampled voltage with internal precise reference to generate error voltage (V_{COMV}), which determines the duty cycle of the MOSFET in CV mode.

Meanwhile, the output current can be estimated using the peak drain current and inductor current discharge time since output current is same as average of the diode current in steady state.

The output current estimator picks up the peak value of the drain current with a peak detection circuit and calculates the output current using the inductor discharge time (t_{DIS}) and switching period (t_s). The output information is compared with internal precise reference to generate error voltage (V_{COMI}), which determines the duty cycle of the MOSFET in CC mode.

Among the two error voltages, V_{COMV} and V_{COMI} , the smaller actually determines the duty cycle. During constant voltage regulation mode, V_{COMV} determines the duty cycle while V_{COMI} is saturated to high. During constant current regulation mode, V_{COMI} determines the duty cycle while V_{COMV} is saturated to HIGH.

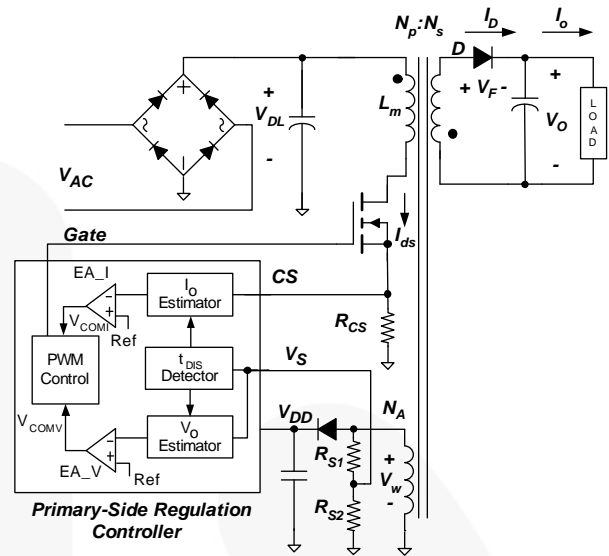

Figure 24. Simplified PSR Flyback Converter Circuit

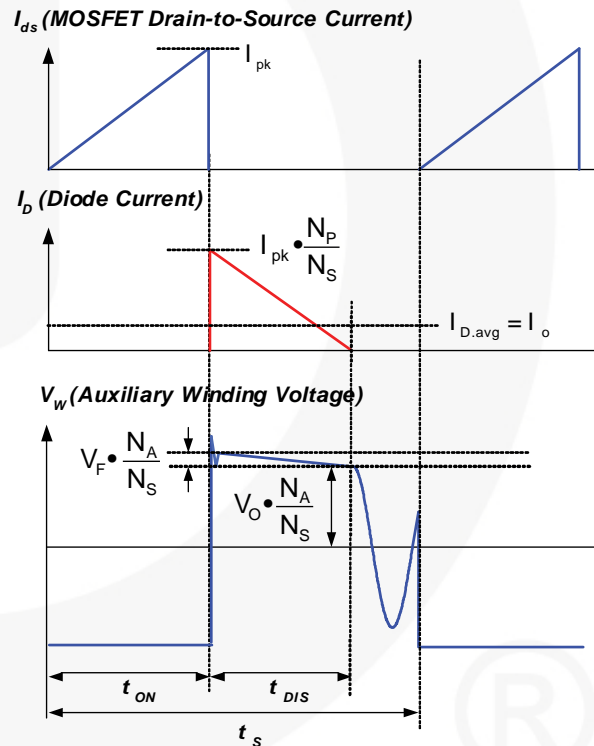

Figure 25. Key Waveforms of DCM Flyback Converter

Cable Voltage Drop Compensation

When it comes to cellular phone charger applications, the actual battery is located at the end of cable, which causes typically several percent of voltage drop on the actual battery voltage. FAN102 has a programmable cable voltage drop compensation, which provides a constant output voltage at the end of the cable over the entire load range in CV mode. As load increases, the voltage drop across the cable is compensated by increasing the reference voltage of voltage regulation error amplifier. The amount of compensation is programmed by the resistor on the COMR pin. The relationship between the amount of compensation and COMR resistor is shown in Figure 26.

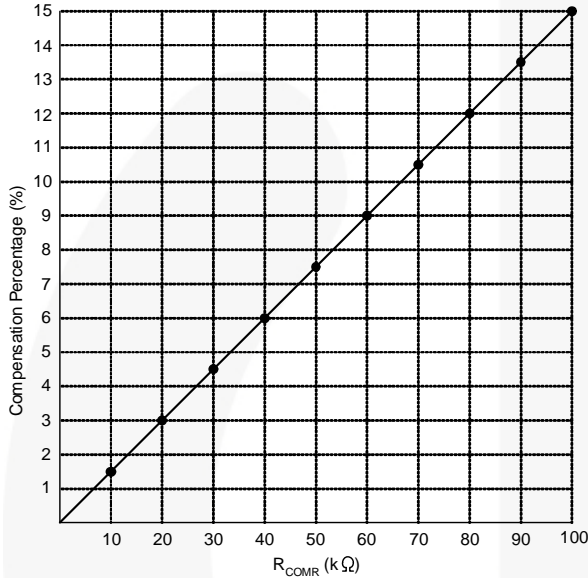

Figure 26. Cable Voltage Drop Compensation

Temperature Compensation

Built-in temperature compensation provides constant voltage regulation over a wide range of temperature variation. This internal compensation current compensates the forward-voltage drop variation of the secondary-side rectifier diode.

Green-Mode Operation

The FAN102 uses voltage regulation error amplifier output (V_{COMV}) as an indicator of the output load and modulates the PWM frequency, as shown in Figure 27, such that the switching frequency decreases as load decreases. In heavy load conditions, the switching frequency is fixed at 42 KHz. Once V_{COMV} decreases below 2.8 V, the PWM frequency starts to linearly decrease from 42 KHz to 550Hz to reduce the switching losses. As V_{COMV} decreases below 0.8 V, the switching frequency is fixed at 550 Hz and FAN102 enters deep green mode, where the operating current reduces to 1mA, further reducing the standby power consumption.

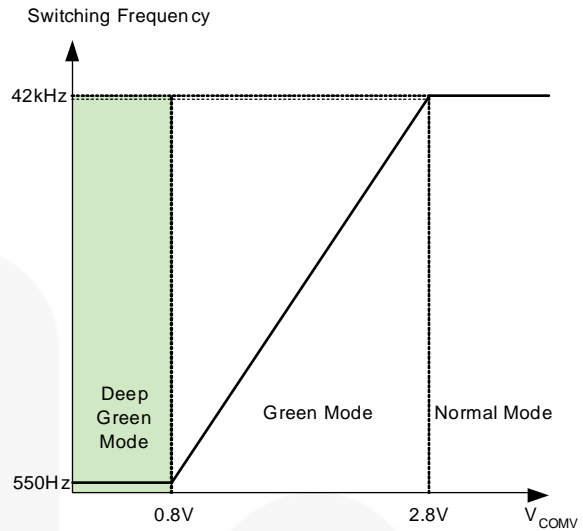

Figure 27. Switching Frequency in Green Mode

Frequency Hopping

EMI reduction is accomplished by frequency hopping, which spreads the energy over a wider frequency range than the bandwidth measured by the EMI test equipment. FAN102 has an internal frequency hopping circuit that changes the switching frequency between 39.4 kHz and 44.6 kHz with a period of 3 ms, as shown in Figure 28.

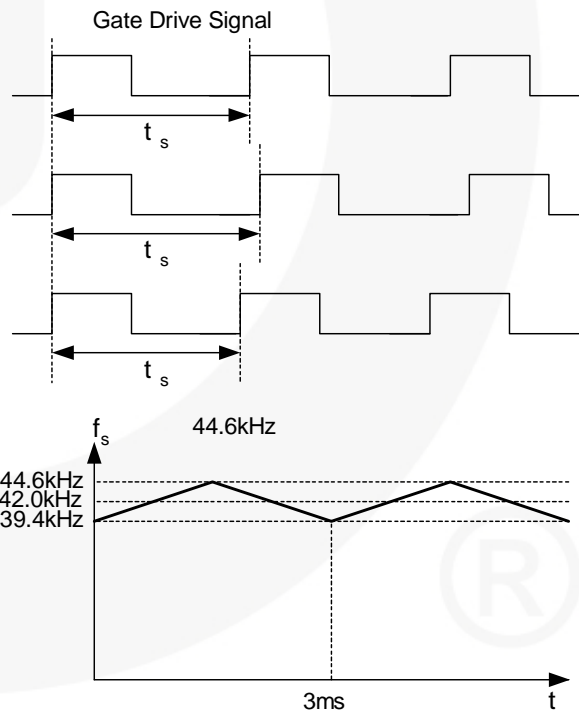

Figure 28. Frequency Hopping

Leading-Edge Blanking (LEB)

At the instant the MOSFET is turned on, a high-current spike occurs through the MOSFET, caused by primary-side capacitance and secondary-side rectifier reverse recovery. Excessive voltage across the R_{CS} resistor can lead to premature turn-off of MOSFET. FAN102 employs an internal leading-edge blanking (LEB) circuit. To inhibit the PWM comparator for a short time after the MOSFET is turned on. Thus, external RC filtering is not required.

Startup

Figure 29 shows the typical startup circuit and transformer auxiliary winding for a FAN102 application. Before FAN102 begins switching, it consumes only startup current (typically $10\ \mu\text{A}$) and the current supplied through the startup resistor charges the V_{DD} capacitor (C_{DD}). When V_{DD} reaches turn-on voltage of $16\ \text{V}$ (V_{DD-ON}), FAN102 begins switching and the current consumed by FAN102 increases to $3.5\ \text{mA}$. Then, the power required for FAN102 is supplied from the transformer auxiliary winding. The large hysteresis of V_{DD} provides more holdup time, which allows using a small capacitor for V_{DD} .

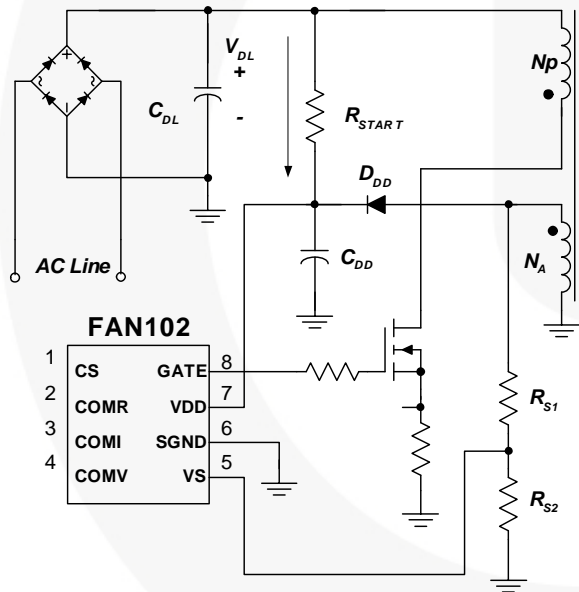

Figure 29. Startup Circuit

Protections

The FAN102 has several self-protective functions, such as Over-Voltage Protection (OVP), Over-Temperature Protection (OTP) and brownout protection. All the protections are implemented as auto-restart mode. Once the fault condition occurs, switching is terminated and the MOSFET remains off. This causes V_{DD} to fall. When V_{DD} reaches the V_{DD} turn-off voltage of $5\ \text{V}$, the current consumed by FAN102 reduces to the startup current (typically $10\ \mu\text{A}$) and the current supplied startup resistor charges the V_{DD} capacitor. When V_{DD} reaches the turn-on voltage of $16\ \text{V}$, FAN102 resumes normal

operation. In this manner, the auto-restart alternately enables and disables the switching of the MOSFET until the fault condition is eliminated (see Figure 30).

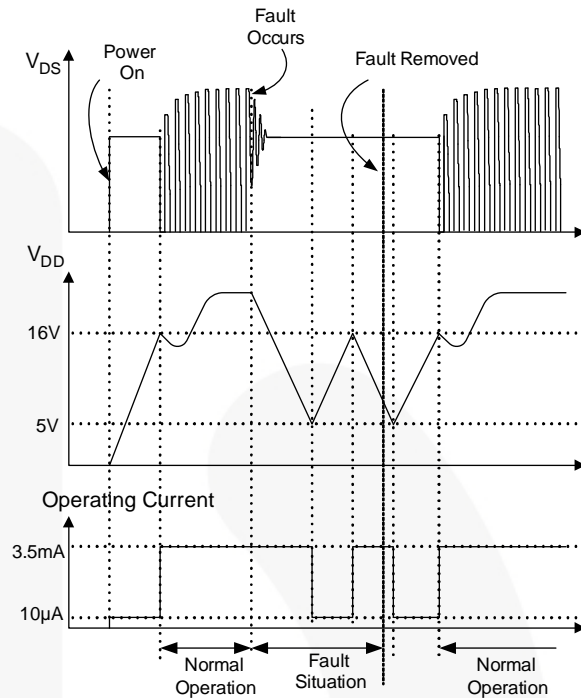

Figure 30. Auto-Restart Operation

V_{DD} Over-Voltage Protection (OVP)

V_{DD} over-voltage protection prevents damage from over-voltage conditions. If the V_{DD} voltage exceeds $28\ \text{V}$ by open feedback condition, OVP is triggered. The OVP has a de-bounce time (typical $250\ \mu\text{s}$) to prevent false trigger by switching noise. It also protects other switching devices from over voltage.

Over-Temperature Protection (OTP)

A built-in temperature-sensing circuit shuts down PWM output if the junction temperature exceeds 140°C .

Brownout Protection

FAN102 detects the line voltage using auxiliary winding voltage since the auxiliary winding voltage reflects the input voltage when the MOSFET is turned on. The VS pin is clamped at $1.15\ \text{V}$ while the MOSFET is turned on and brownout protection is triggered if the current out of the VS pin is less than I_{VS-UVP} (typical $180\ \mu\text{A}$) during the MOSFET conduction.

Pulse-by-Pulse Current Limit

When the sensing voltage across the current sense resistor exceeds the internal threshold of $1.4\ \text{V}$, the MOSFET is turned off for the remainder of switching cycle. In normal operation, the pulse-by-pulse current limit is not triggered since the peak current is limited by the control loop.

Typical Application Circuit (Primary-Side Regulated Flyback Charger)

Application	Fairchild Devices	Input Voltage Range	Output
Cell Phone Charger	FAN102	90~265 V _{AC}	5 V/0.78 A (3.9 W)

Features

- High efficiency (>68% at full load) meeting Energy StarSM V2.0 and CEC regulation with enough margin
- Low standby power consumption (Pin=0.087 W for 115 V_{AC} and Pin=0.123 W for 230 V)
- Tight output regulation (CV:±5%, CC:±7%)

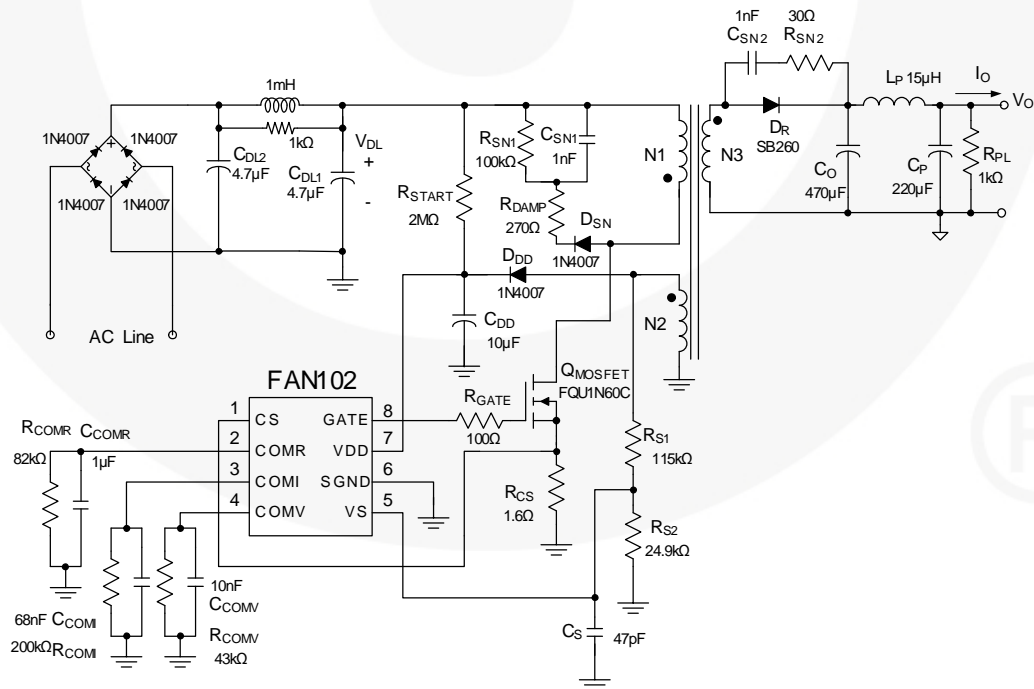
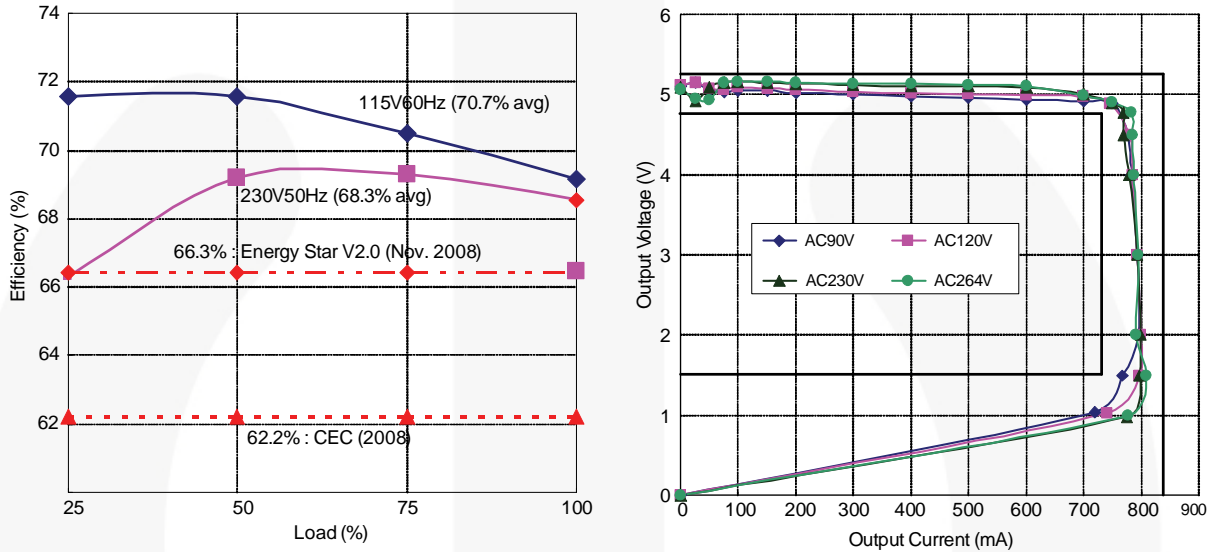

Typical Application Circuit (Continued)

Transformer specification

- Core: EE16
- Bobbin: EE16

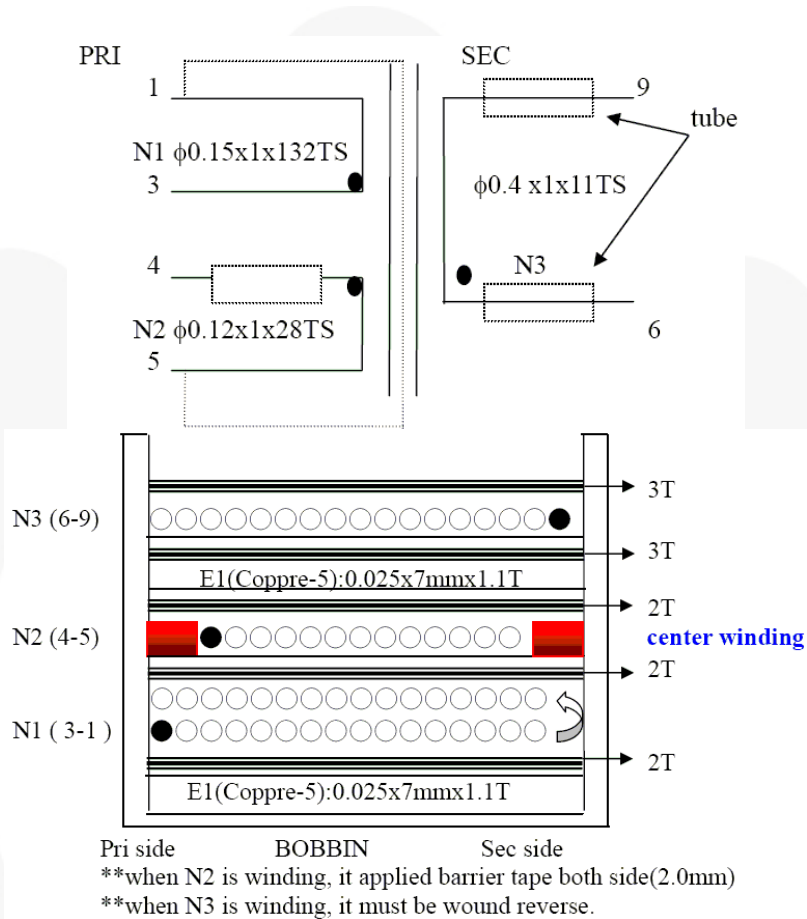

	Pin	Specification	Remark
Primary-Side Inductance	1-3	2.3 mH \pm 5%	100 kHz, 1 V
Primary-Side Effective Leakage	1-8	65 μ H \pm 5%.	Short one of the secondary windings

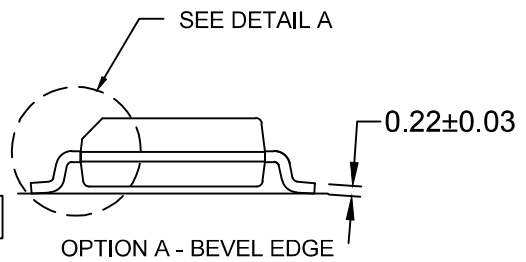
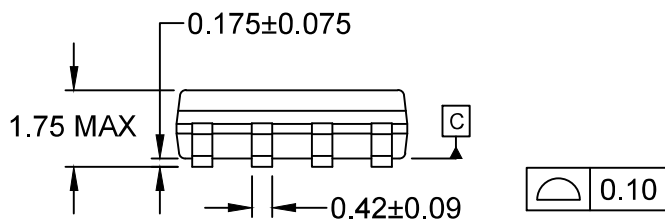

NOTES:

- A) THIS PACKAGE CONFORMS TO JEDEC MS-012, VARIATION AA.
- B) ALL DIMENSIONS ARE IN MILLIMETERS.
- C) DIMENSIONS DO NOT INCLUDE MOLD FLASH OR BURRS.
- D) LANDPATTERN STANDARD: SOIC127P600X175-8M
- E) DRAWING FILENAME: M08Arev16



ON Semiconductor and  are trademarks of Semiconductor Components Industries, LLC dba ON Semiconductor or its subsidiaries in the United States and/or other countries. ON Semiconductor owns the rights to a number of patents, trademarks, copyrights, trade secrets, and other intellectual property. A listing of ON Semiconductor's product/patent coverage may be accessed at www.onsemi.com/site/pdf/Patent-Marking.pdf. ON Semiconductor reserves the right to make changes without further notice to any products herein. ON Semiconductor makes no warranty, representation or guarantee regarding the suitability of its products for any particular purpose, nor does ON Semiconductor assume any liability arising out of the application or use of any product or circuit, and specifically disclaims any and all liability, including without limitation special, consequential or incidental damages. Buyer is responsible for its products and applications using ON Semiconductor products, including compliance with all laws, regulations and safety requirements or standards, regardless of any support or applications information provided by ON Semiconductor. "Typical" parameters which may be provided in ON Semiconductor data sheets and/or specifications can and do vary in different applications and actual performance may vary over time. All operating parameters, including "Typicals" must be validated for each customer application by customer's technical experts. ON Semiconductor does not convey any license under its patent rights nor the rights of others. ON Semiconductor products are not designed, intended, or authorized for use as a critical component in life support systems or any FDA Class 3 medical devices or medical devices with a same or similar classification in a foreign jurisdiction or any devices intended for implantation in the human body. Should Buyer purchase or use ON Semiconductor products for any such unintended or unauthorized application, Buyer shall indemnify and hold ON Semiconductor and its officers, employees, subsidiaries, affiliates, and distributors harmless against all claims, costs, damages, and expenses, and reasonable attorney fees arising out of, directly or indirectly, any claim of personal injury or death associated with such unintended or unauthorized use, even if such claim alleges that ON Semiconductor was negligent regarding the design or manufacture of the part. ON Semiconductor is an Equal Opportunity/Affirmative Action Employer. This literature is subject to all applicable copyright laws and is not for resale in any manner.

PUBLICATION ORDERING INFORMATION

LITERATURE FULFILLMENT:

Literature Distribution Center for ON Semiconductor
19521 E. 32nd Pkwy, Aurora, Colorado 80011 USA
Phone: 303-675-2175 or 800-344-3860 Toll Free USA/Canada
Fax: 303-675-2176 or 800-344-3867 Toll Free USA/Canada
Email: orderlit@onsemi.com

N. American Technical Support: 800-282-9855 Toll Free
USA/Canada
Europe, Middle East and Africa Technical Support:
Phone: 421 33 790 2910
Japan Customer Focus Center
Phone: 81-3-5817-1050

ON Semiconductor Website: www.onsemi.com
Order Literature: <http://www.onsemi.com/orderlit>
For additional information, please contact your local
Sales Representative