

FCMT125N65S3

Power MOSFET, N-Channel, SUPERFET[®] III, Easy-Drive, 650 V, 24 A, 125 mΩ

General Description

SUPERFET III MOSFET is ON Semiconductor's brand-new high voltage super-junction (SJ) MOSFET family that is utilizing charge balance technology for outstanding low on-resistance and lower gate charge performance. This advanced technology is tailored to minimize conduction loss, provide superior switching performance, and withstand extreme dv/dt rate.

Consequently, SUPERFET III MOSFET Easy-drive series helps manage EMI issues and allows for easier design implementation.

The Power88 package is an ultra-slim surface-mount package (1 mm high) with a low profile and small footprint (8 × 8 mm²). SUPERFET III MOSFET in a Power88 package offers excellent switching performance due to lower parasitic source inductance and separated power and drive sources. Power88 offers Moisture Sensitivity Level 1 (MSL 1).

Features

- 700 V @ T_J = 150°C
- Typ R_{DS(on)} = 100 mΩ
- Ultra Low Gate Charge (Typ. Q_g = 49 nC)
- Low Effective Output Capacitance (Typ. C_{oss(eff.)} = 406 pF)
- 100% Avalanche Tested
- These Devices are Pb-Free and are RoHS Compliant

Applications

- Telecom / Server Power Supplies
- Industrial Power Supplies
- UPS / Solar



ON Semiconductor[®]

www.onsemi.com

V _{DSS}	R _{DS(ON)} MAX	I _D MAX
650 V	125 mΩ @ 10 V	24 A

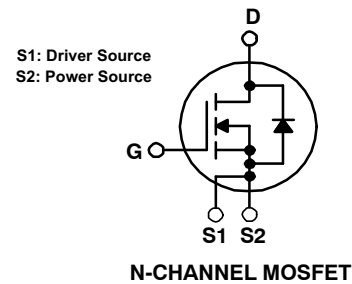

Power 88
PQFN4 8X8 2P
CASE 483AP

MARKING DIAGRAM

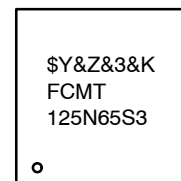

\$Y = ON Semiconductor Logo
&Z = Assembly Plant Code
&3 = Data Code (Year & Week)
&K = Lot
FCMT125N65S3 = Specific Device Code

ORDERING INFORMATION

See detailed ordering and shipping information on page 2 of this data sheet.

FCMT125N65S3

ABSOLUTE MAXIMUM RATINGS (T_C = 25°C, Unless otherwise noted)

Symbol	Parameter		Value	Unit
V _{DSS}	Drain to Source Voltage		650	V
V _{GSS}	Gate to Source Voltage	DC	±30	V
		AC (f > 1 Hz)	±30	V
I _D	Drain Current	Continuous (T _C = 25°C)	24	A
		Continuous (T _C = 100°C)	15	
I _{DM}	Drain Current	Pulsed (Note 1)	60	A
E _{AS}	Single Pulsed Avalanche Energy (Note 2)		115	mJ
I _{AS}	Avalanche Current (Note 2)		3.7	A
E _{AR}	Repetitive Avalanche Energy (Note 1)		1.81	mJ
dv/dt	MOSFET dv/dt		100	V/ns
	Peak Diode Recovery dv/dt (Note 3)		20	
P _D	Power Dissipation	(T _C = 25°C)	181	W
		Derate Above 25°C	1.45	W/°C
T _J , T _{STG}	Operating and Storage Temperature Range		-55 to +150	°C
T _L	Maximum Lead Temperature for Soldering, 1/8" from Case for 5 s		300	°C

Stresses exceeding those listed in the Maximum Ratings table may damage the device. If any of these limits are exceeded, device functionality should not be assumed, damage may occur and reliability may be affected.

1. Repetitive rating: pulse-width limited by maximum junction temperature.
2. I_{AS} = 3.7 A, R_G = 25 Ω starting T_J = 25°C
3. I_{SD} ≤ 12 A, di/dt ≤ 200 A/μs, V_{DD} ≤ 400 V, starting T_J = 25°C

THERMAL CHARACTERISTICS

Symbol	Parameter	Value	Unit
R _{θJC}	Thermal Resistance, Junction to Case, Max.	0.69	°C/W
R _{θJA}	Thermal Resistance, Junction to Ambient, Max. (Note 4)	45	

4. Device on 1 in² pad 2 oz copper pad on 1.5 × 1.5 in. board of FR-4 material.

ORDERING INFORMATION

Device	Marking	Package	Reel Size	Tape Width	Quantity [†]
FCMT125N65S3	FCMT125N65S3	Power 88	13"	13.3 mm	3000 Units

[†]For information on tape and reel specifications, including part orientation and tape sizes, please refer to our Tape and Reel Packaging Specifications Brochure, BRD8011/D.

FCMT125N65S3

ELECTRICAL CHARACTERISTICS ($T_C = 25^\circ\text{C}$ unless otherwise noted)

Symbol	Parameter	Test Conditions	Min	Typ	Max	Unit
--------	-----------	-----------------	-----	-----	-----	------

OFF CHARACTERISTICS

BV _{DSS}	Drain to Source Breakdown Voltage	V _{GS} = 0 V, I _D = 1 mA, T _J = 25°C	650			V
		V _{GS} = 0 V, I _D = 1 mA, T _J = 150°C	700			V
ΔBV _{DSS} /ΔT _J	Breakdown Voltage Temperature Coefficient	I _D = 1 mA, Referenced to 25°C		0.68		V/°C
I _{DSS}	Zero Gate Voltage Drain Current	V _{DS} = 650 V, V _{GS} = 0 V			10	μA
		V _{DS} = 520 V, T _C = 125°C		1.35		
I _{GSS}	Gate to Body Leakage Current	V _{GS} = ±30 V, V _{DS} = 0 V			±100	nA

ON CHARACTERISTICS

V _{GS(th)}	Gate Threshold Voltage	V _{GS} = V _{DS} , I _D = 0.59 mA	2.5		4.5	V
R _{DS(on)}	Static Drain to Source On Resistance	V _{GS} = 10 V, I _D = 12 A		100	125	mΩ
g _{FS}	Forward Transconductance	V _{DS} = 20 V, I _D = 12 A		16		S

DYNAMIC CHARACTERISTICS

C _{iss}	Input Capacitance	V _{DS} = 400 V, V _{GS} = 0 V, f = 1 MHz		1920		pF
C _{oss}	Output Capacitance			44		pF
C _{oss(eff.)}	Effective Output Capacitance	V _{DS} = 0 V to 400 V, V _{GS} = 0 V		406		pF
C _{oss(er.)}	Energy Related Output Capacitance	V _{DS} = 0 V to 400 V, V _{GS} = 0 V		63		pF
Q _{g(tot)}	Total Gate Charge at 10V	V _{DS} = 400 V, I _D = 12 A, V _{GS} = 10 V (Note 5)		49		nC
Q _{gs}	Gate to Source Gate Charge			12		nC
Q _{gd}	Gate to Drain "Miller" Charge			22		nC
ESR	Equivalent Series Resistance	f = 1 MHz		0.5		Ω

SWITCHING CHARACTERISTICS

t _{d(on)}	Turn-On Delay Time	V _{DD} = 400 V, I _D = 12 A, V _{GS} = 10 V, R _g = 4.7 Ω (Note 5)		22		ns
t _r	Turn-On Rise Time			22		ns
t _{d(off)}	Turn-Off Delay Time			60		ns
t _f	Turn-Off Fall Time			5.8		ns

SOURCE-DRAIN DIODE CHARACTERISTICS

I _S	Maximum Continuous Source to Drain Diode Forward Current			24		A
I _{SM}	Maximum Pulsed Source to Drain Diode Forward Current			60		A
V _{SD}	Source to Drain Diode Forward Voltage	V _{GS} = 0 V, I _{SD} = 12 A			1.2	V
t _{rr}	Reverse Recovery Time	V _{DD} = 400 V, I _{SD} = 12 A, dI _F /dt = 100 A/μs		345		ns
Q _{rr}	Reverse Recovery Charge			5.7		μC

Product parametric performance is indicated in the Electrical Characteristics for the listed test conditions, unless otherwise noted. Product performance may not be indicated by the Electrical Characteristics if operated under different conditions.

5. Essentially independent of operating temperature typical characteristics.

TYPICAL PERFORMANCE CHARACTERISTICS

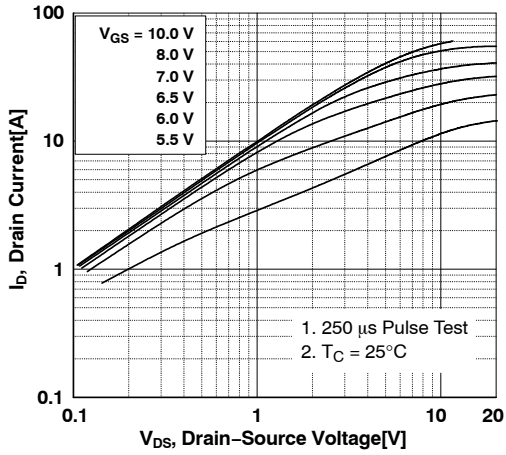

Figure 1. On-Region Characteristics

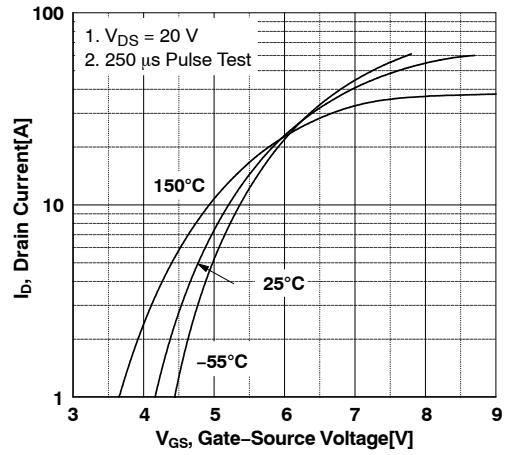

Figure 2. Transfer Characteristics

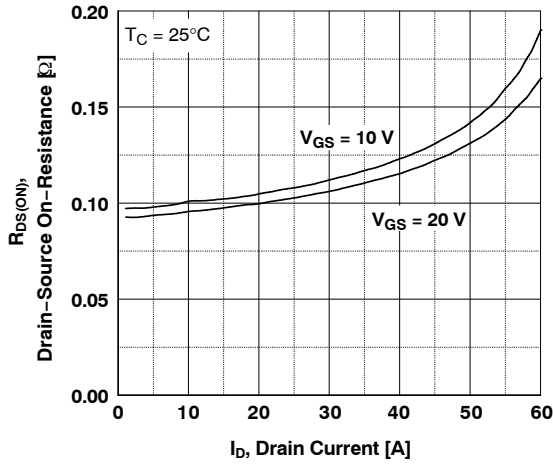

Figure 3. On-Resistance Variation vs. Drain Current and Gate Voltage

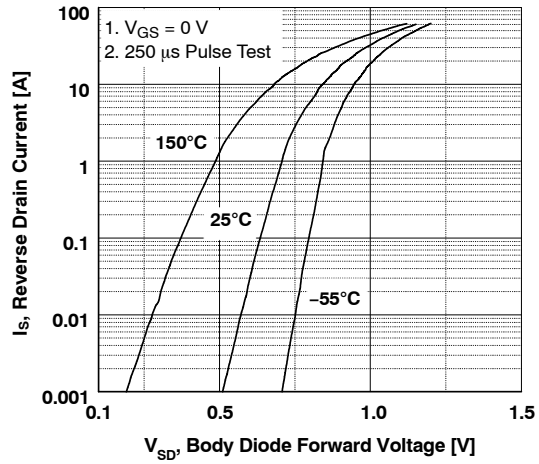

Figure 4. Body Diode Forward Voltage Variation vs. Source Current and Temperature

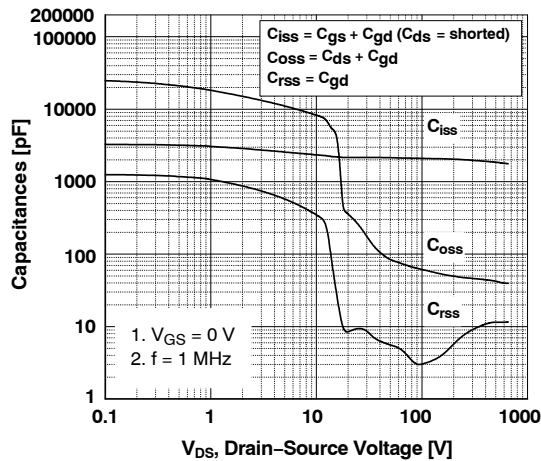

Figure 5. Capacitance Characteristics

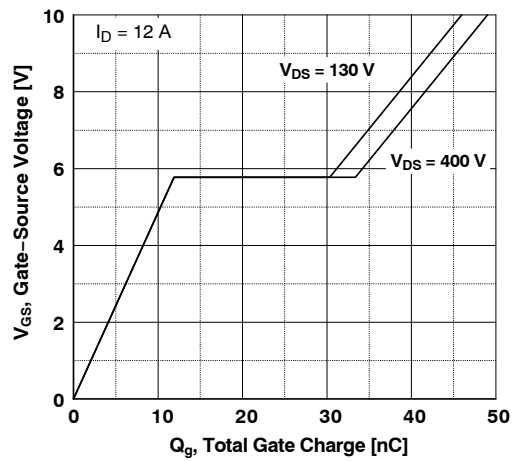

Figure 6. Gate Charge Characteristics

TYPICAL PERFORMANCE CHARACTERISTICS (Continued)

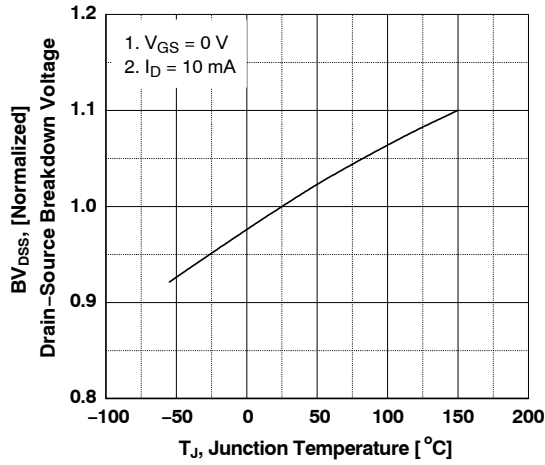

Figure 7. Breakdown Voltage Variation vs. Temperature

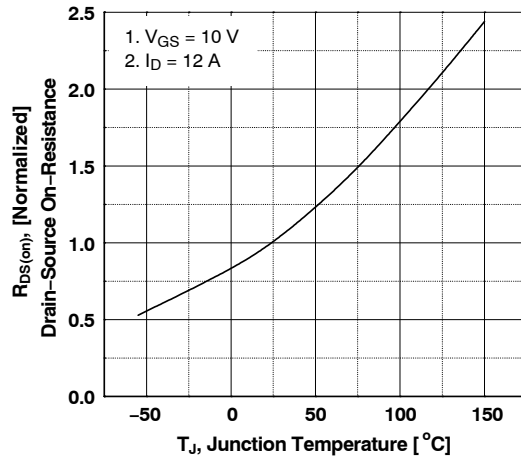

Figure 8. On-Resistance Variant vs. Temperature

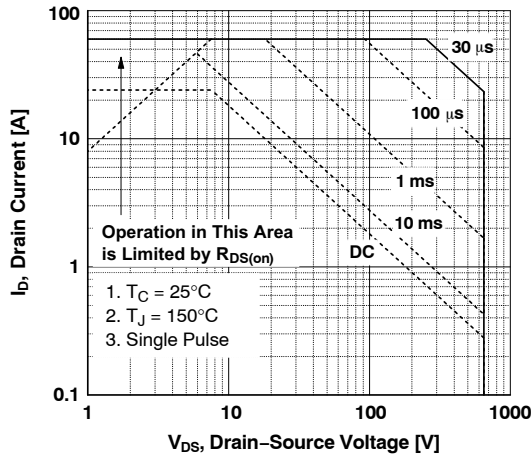

Figure 9. Maximum Safe Operation Area

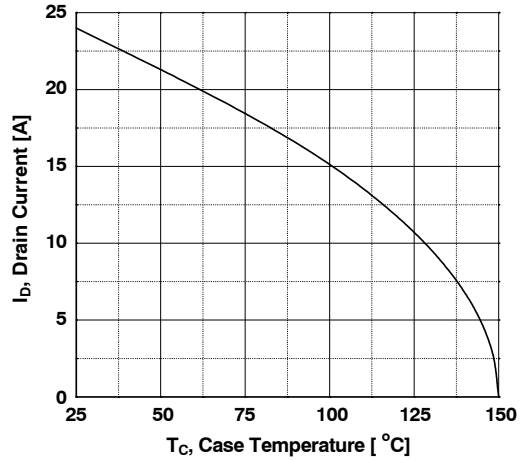

Figure 10. Maximum Drain Current vs. Case Temperature

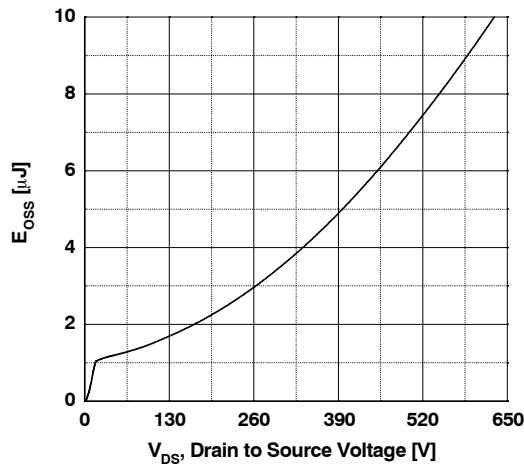

Figure 11. E_{OSS} vs. Drain to Source Voltage

FCMT125N65S3

TYPICAL PERFORMANCE CHARACTERISTICS (Continued)

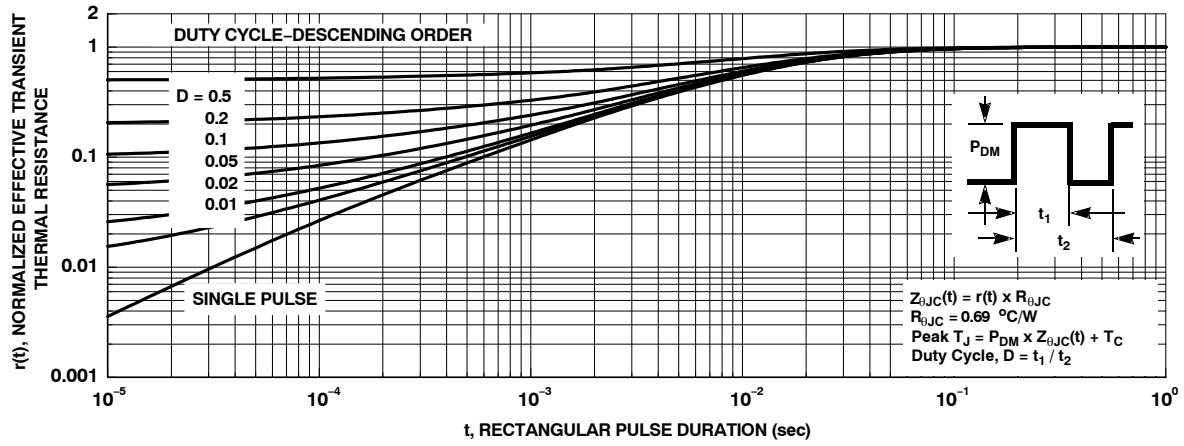

Figure 12. Transient Thermal Response Curve

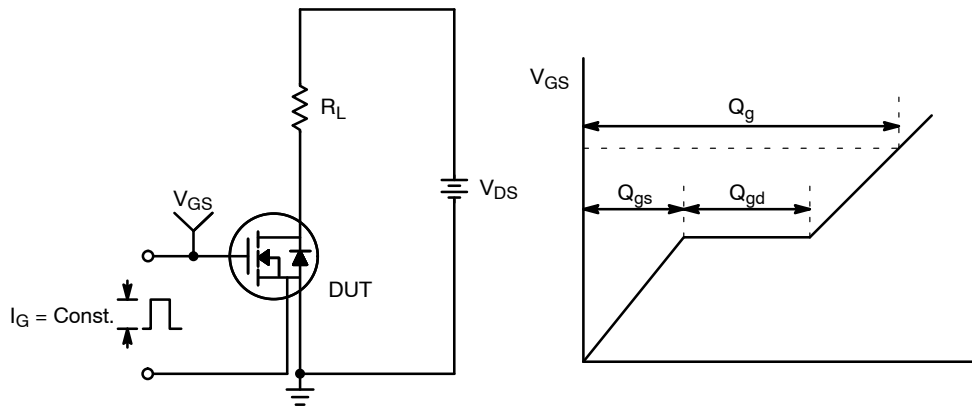

Figure 13. Gate Charge Test Circuit & Waveform

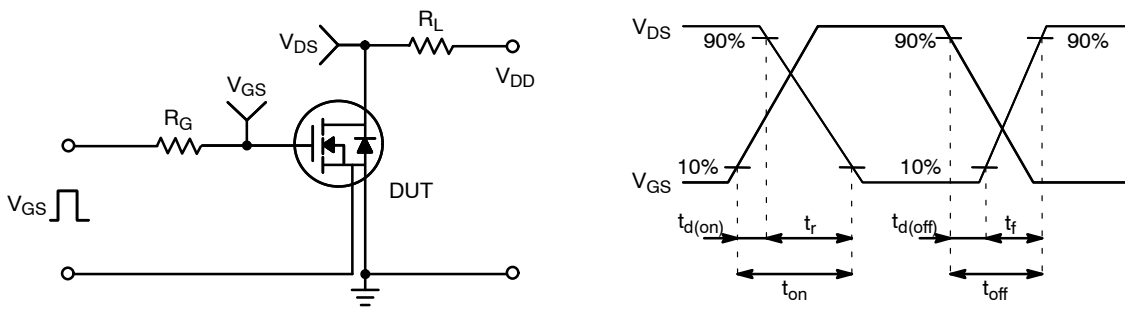

Figure 14. Resistive Switching Test Circuit & Waveforms

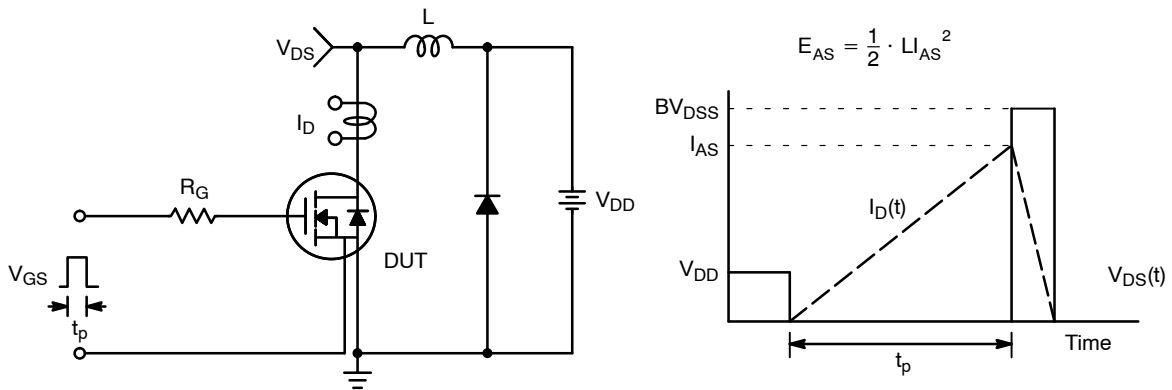

Figure 15. Unclamped Inductive Switching Test Circuit & Waveforms

FCMT125N65S3

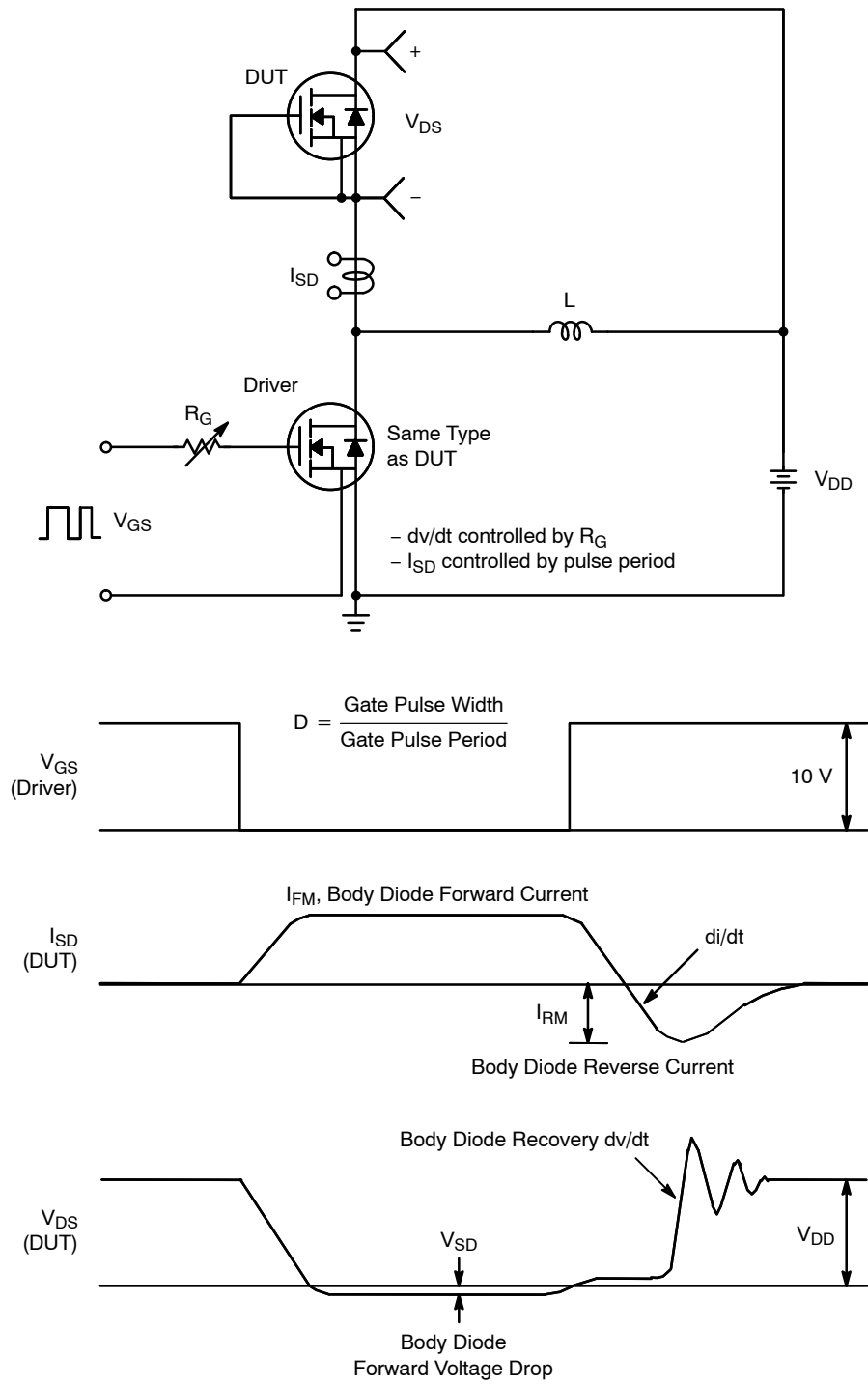
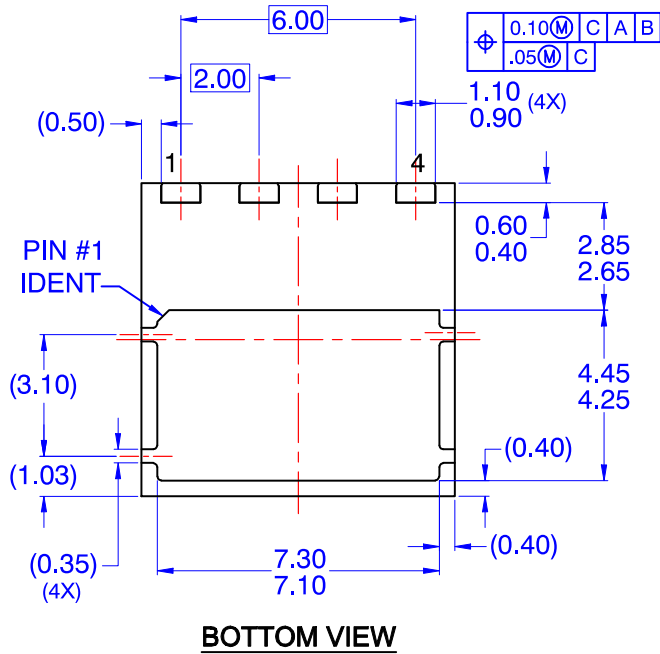
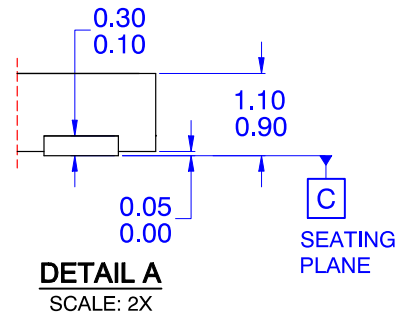
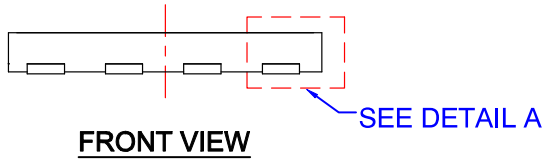
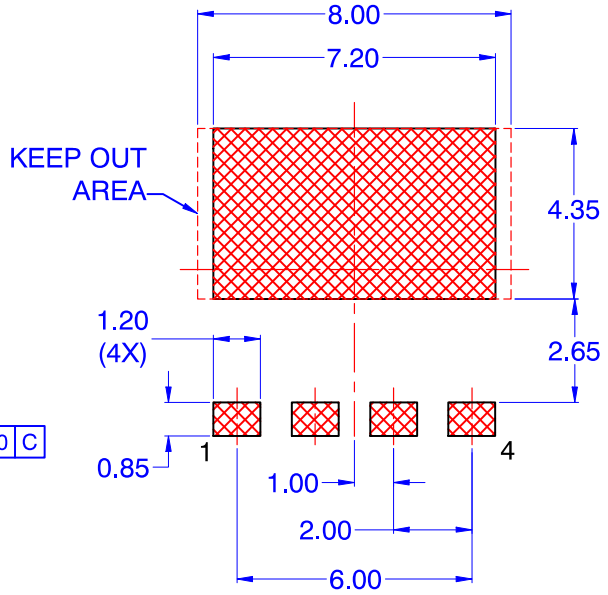
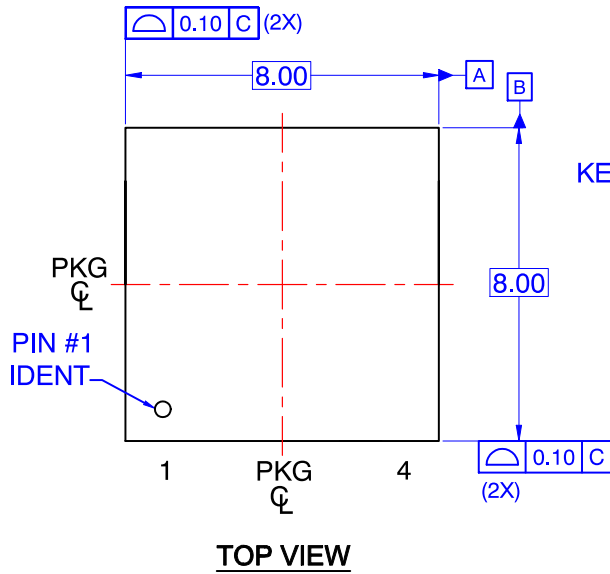

Figure 16. Peak Diode Recovery dv/dt Test Circuit & Waveforms

FCMT125N65S3

PACKAGE DIMENSIONS

PQFN4 8X8, 2P
CASE 483AP
ISSUE O



NOTES: UNLESS OTHERWISE SPECIFIED
A) THIS PACKAGE IS NOT PRESENTLY REGISTERED WITH ANY STANDARDS COMMITTEE.
B) DIMENSIONS ARE INCLUSIVE OF BURRS, MOLD FLASH, AND TIE BAR PROTRUSIONS.
C) ALL DIMENSIONS ARE IN MILLIMETERS.
D) DRAWING CONFORMS TO ASME Y14.5M-1994.

SUPERFET is a registered trademark of Semiconductor Components Industries, LLC.

ON Semiconductor and  are trademarks of Semiconductor Components Industries, LLC dba ON Semiconductor or its subsidiaries in the United States and/or other countries. ON Semiconductor owns the rights to a number of patents, trademarks, copyrights, trade secrets, and other intellectual property. A listing of ON Semiconductor's product/patent coverage may be accessed at www.onsemi.com/site/pdf/Patent-Marking.pdf. ON Semiconductor reserves the right to make changes without further notice to any products herein. ON Semiconductor makes no warranty, representation or guarantee regarding the suitability of its products for any particular purpose, nor does ON Semiconductor assume any liability arising out of the application or use of any product or circuit, and specifically disclaims any and all liability, including without limitation special, consequential or incidental damages. Buyer is responsible for its products and applications using ON Semiconductor products, including compliance with all laws, regulations and safety requirements or standards, regardless of any support or applications information provided by ON Semiconductor. "Typical" parameters which may be provided in ON Semiconductor data sheets and/or specifications can and do vary in different applications and actual performance may vary over time. All operating parameters, including "Typicals" must be validated for each customer application by customer's technical experts. ON Semiconductor does not convey any license under its patent rights nor the rights of others. ON Semiconductor products are not designed, intended, or authorized for use as a critical component in life support systems or any FDA Class 3 medical devices or medical devices with a same or similar classification in a foreign jurisdiction or any devices intended for implantation in the human body. Should Buyer purchase or use ON Semiconductor products for any such unintended or unauthorized application, Buyer shall indemnify and hold ON Semiconductor and its officers, employees, subsidiaries, affiliates, and distributors harmless against all claims, costs, damages, and expenses, and reasonable attorney fees arising out of, directly or indirectly, any claim of personal injury or death associated with such unintended or unauthorized use, even if such claim alleges that ON Semiconductor was negligent regarding the design or manufacture of the part. ON Semiconductor is an Equal Opportunity/Affirmative Action Employer. This literature is subject to all applicable copyright laws and is not for resale in any manner.

PUBLICATION ORDERING INFORMATION

LITERATURE FULFILLMENT:

Literature Distribution Center for ON Semiconductor
19521 E. 32nd Pkwy, Aurora, Colorado 80011 USA
Phone: 303-675-2175 or 800-344-3860 Toll Free USA/Canada
Fax: 303-675-2176 or 800-344-3867 Toll Free USA/Canada
Email: orderlit@onsemi.com

N. American Technical Support: 800-282-9855 Toll Free
USA/Canada
Europe, Middle East and Africa Technical Support:
Phone: 421 33 790 2910

ON Semiconductor Website: www.onsemi.com

Order Literature: <http://www.onsemi.com/orderlit>

For additional information, please contact your local
Sales Representative