



ON Semiconductor®

# FDA20N50-F109

## N-Channel UniFET™ MOSFET

500 V, 20 A, 230 mΩ

### Features

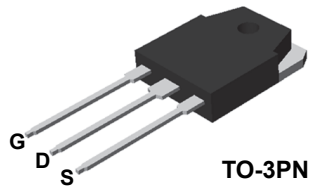
- $R_{DS(on)} = 230\text{ m}\Omega$  (Max.) @  $V_{GS} = 10\text{ V}$ ,  $I_D = 10\text{ A}$
- Low Gate Charge (Typ. 45.6 nC)
- Low  $C_{rss}$  (Typ. 27 pF)
- 100% Avalanche Tested
- Improved dv/dt Capability

### Applications

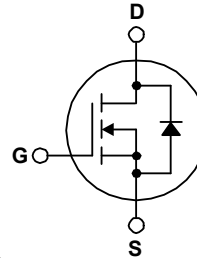
- PDP TV
- Uninterruptible Power Supply
- AC-DC Power Supply

### Description

UniFET™ MOSFET is ON Semiconductor's high voltage MOSFET family based on planar stripe and DMOS technology. This MOSFET is tailored to reduce on-state resistance, and to provide better switching performance and higher avalanche energy strength. This device family is suitable for switching power converter applications such as power factor correction (PFC), flat panel display (FPD) TV power, ATX and electronic lamp ballasts.



TO-3PN



### Absolute Maximum Ratings $T_C = 25^\circ\text{C}$ unless otherwise noted.

Symbol	Parameter	FDA20N50-F109	Unit
$V_{DSS}$	Drain-Source Voltage	500	V
$I_D$	Drain Current	- Continuous ( $T_C = 25^\circ\text{C}$ )	22
		- Continuous ( $T_C = 100^\circ\text{C}$ )	13.2
$I_{DM}$	Drain Current	- Pulsed (Note 1)	88
$V_{GSS}$	Gate-Source voltage	$\pm 30$	V
$E_{AS}$	Single Pulsed Avalanche Energy (Note 2)	1110	mJ
$I_{AR}$	Avalanche Current (Note 1)	22	A
$E_{AR}$	Repetitive Avalanche Energy (Note 1)	28.0	mJ
dv/dt	Peak Diode Recovery dv/dt (Note 3)	20	V/ns
$P_D$	Power Dissipation	( $T_C = 25^\circ\text{C}$ )	280
		- Derate above $25^\circ\text{C}$	2.3
$T_J, T_{STG}$	Operating and Storage Temperature Range	-55 to +150	$^\circ\text{C}$
$T_L$	Maximum Lead Temperature for Soldering Purpose, 1/8" from Case for 5 Seconds	300	$^\circ\text{C}$

### Thermal Characteristics

Symbol	Parameter	FDA20N50-F109	Unit
$R_{\theta JC}$	Thermal Resistance, Junction-to-Case, Max.	0.44	$^\circ\text{C}/\text{W}$
$R_{\theta JA}$	Thermal Resistance, Junction-to-Ambient, Max.	40	$^\circ\text{C}/\text{W}$

FDA20N50-F109 — N-Channel UniFET™ MOSFET

## Package Marking and Ordering Information

Device Marking	Device	Package	Reel Size	Tape Width	Quantity
FDA20N50	FDA20N50-F109	TO-3PN	Tube	N/A	30 units

## Electrical Characteristics $T_C = 25^\circ\text{C}$ unless otherwise noted.

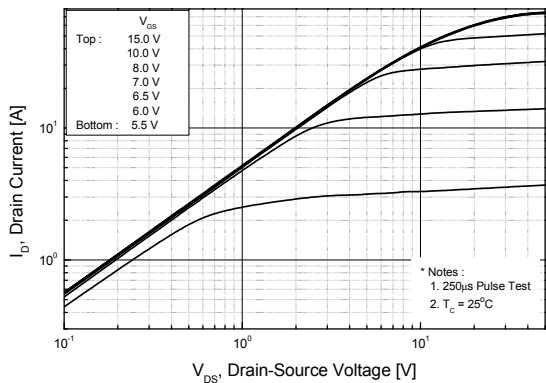
Symbol	Parameter	Conditions	Min	Typ	Max	Unit
<b>Off Characteristics</b>						
$BV_{DSS}$	Drain-Source Breakdown Voltage	$V_{GS} = 0V, I_D = 250\mu A, T_J = 25^\circ\text{C}$	500	--	--	V
$\frac{\Delta BV_{DSS}}{\Delta T_J}$	Breakdown Voltage Temperature Coefficient	$I_D = 250\mu A$ , Referenced to $25^\circ\text{C}$	--	0.50	--	$V/^\circ\text{C}$
$I_{DSS}$	Zero Gate Voltage Drain Current	$V_{DS} = 500V, V_{GS} = 0V$ $V_{DS} = 400V, T_C = 125^\circ\text{C}$	--	--	1 10	$\mu A$ $\mu A$
$I_{GSSF}$	Gate-Body Leakage Current, Forward	$V_{GS} = 30V, V_{DS} = 0V$	--	--	100	nA
$I_{GSSR}$	Gate-Body Leakage Current, Reverse	$V_{GS} = -30V, V_{DS} = 0V$	--	--	-100	nA
<b>On Characteristics</b>						
$V_{GS(th)}$	Gate Threshold Voltage	$V_{DS} = V_{GS}, I_D = 250\mu A$	3.0	--	5.0	V
$R_{DS(on)}$	Static Drain-Source On-Resistance	$V_{GS} = 10V, I_D = 11A$	--	0.20	0.23	$\Omega$
$g_{FS}$	Forward Transconductance	$V_{DS} = 40V, I_D = 11A$	--	24.6	--	S
<b>Dynamic Characteristics</b>						
$C_{iss}$	Input Capacitance	$V_{DS} = 25V, V_{GS} = 0V,$ $f = 1.0\text{MHz}$	--	2400	3120	pF
$C_{oss}$	Output Capacitance		--	355	465	pF
$C_{rss}$	Reverse Transfer Capacitance		--	27	--	pF
<b>Switching Characteristics</b>						
$t_{d(on)}$	Turn-On Delay Time	$V_{DD} = 250V, I_D = 20A$ $R_G = 25\Omega$	--	95	200	ns
$t_r$	Turn-On Rise Time		--	375	760	ns
$t_{d(off)}$	Turn-Off Delay Time		--	100	210	ns
$t_f$	Turn-Off Fall Time		(Note 4)	--	105	220
$Q_g$	Total Gate Charge	$V_{DS} = 400V, I_D = 20A$ $V_{GS} = 10V$	--	45.6	59.5	nC
$Q_{gs}$	Gate-Source Charge		--	14.8	--	nC
$Q_{gd}$	Gate-Drain Charge		(Note 4)	--	21.6	--
<b>Drain-Source Diode Characteristics and Maximum Ratings</b>						
$I_S$	Maximum Continuous Drain-Source Diode Forward Current		--	--	20	A
$I_{SM}$	Maximum Pulsed Drain-Source Diode Forward Current		--	--	80	A
$V_{SD}$	Drain-Source Diode Forward Voltage	$V_{GS} = 0V, I_S = 22A$	--	--	1.4	V
$t_{rr}$	Reverse Recovery Time	$V_{GS} = 0V, I_S = 20A$ $di_F/dt = 100A/\mu s$	--	507	--	ns
$Q_{rr}$	Reverse Recovery Charge		--	7.20	--	$\mu C$

### NOTES:

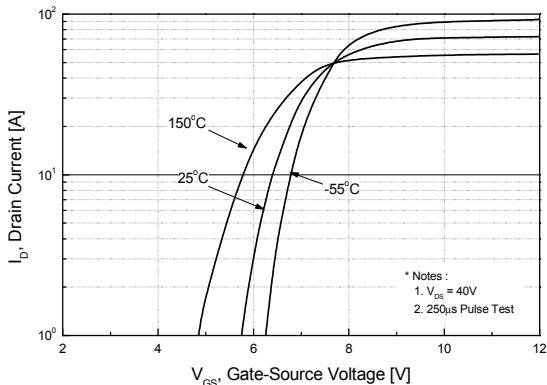
1. Repetitive Rating: Pulse width limited by maximum junction temperature
2.  $L = 4.1\text{mH}, I_{AS} = 22A, V_{DD} = 50V, R_G = 25\Omega$ , Starting  $T_J = 25^\circ\text{C}$
3.  $I_{SD} \leq 22A, di/dt \leq 200A/\mu s, V_{DD} \leq BV_{DSS}$ , Starting  $T_J = 25^\circ\text{C}$
4. Essentially Independent of Operating Temperature Typical Characteristics

## Typical Characteristics

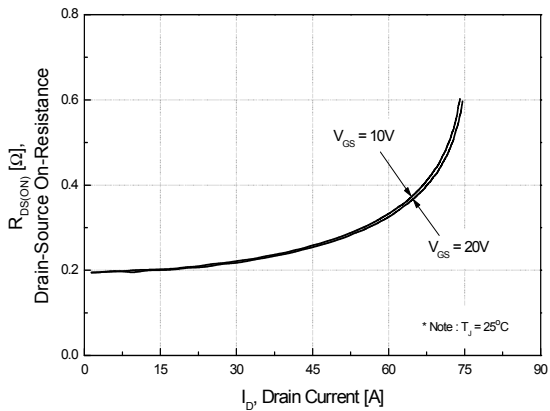
**Figure 1. On-Region Characteristics**



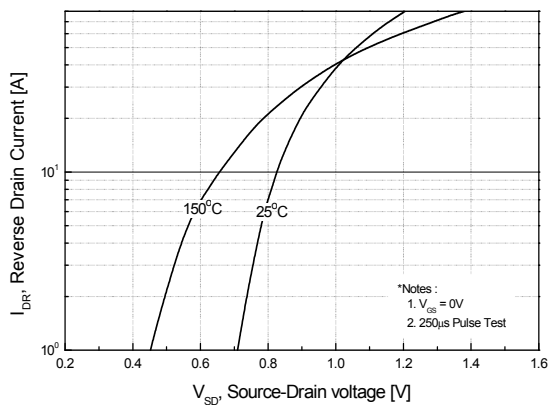
**Figure 2. Transfer Characteristics**



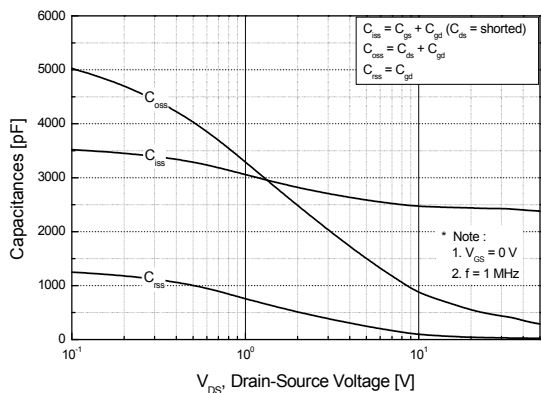
**Figure 3. On-Resistance Variation vs. Drain Current and Gate Voltage**



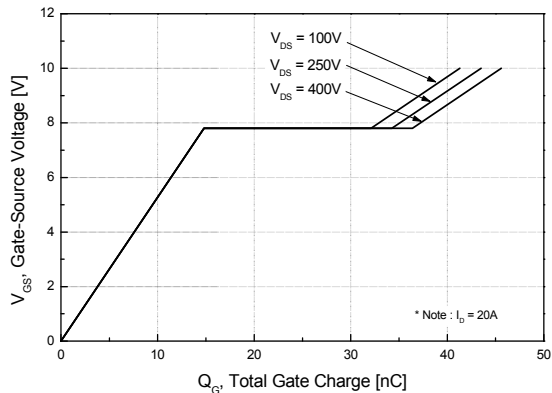
**Figure 4. Body Diode Forward Voltage Variation vs. Source Current and Temperature**



**Figure 5. Capacitance Characteristics**

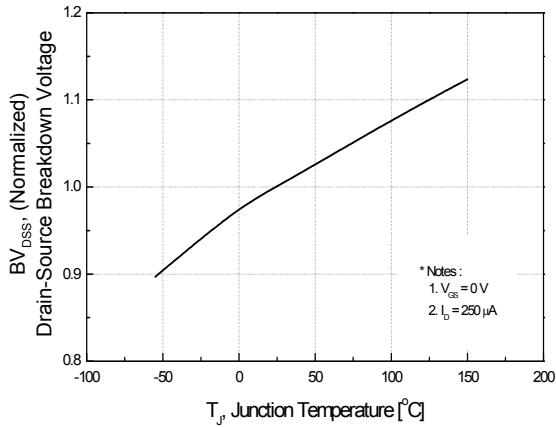


**Figure 6. Gate Charge Characteristics**

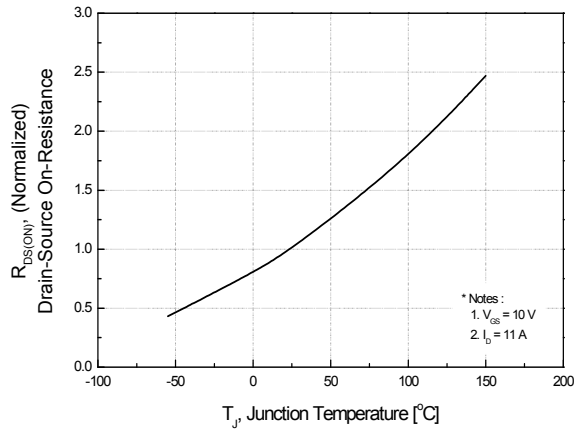


**Typical Characteristics** (Continued)

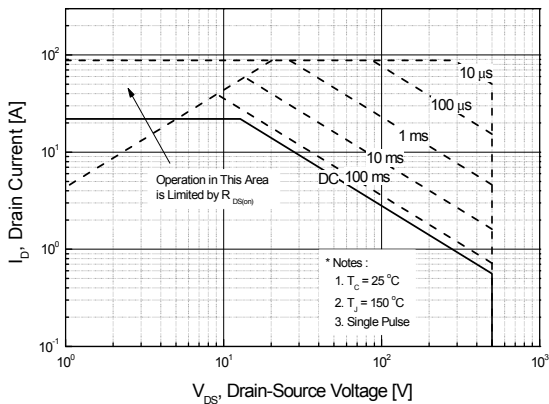
**Figure 7. Breakdown Voltage Variation vs. Temperature**



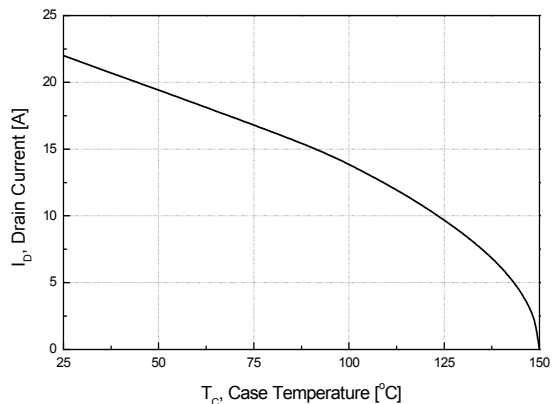
**Figure 8. On-Resistance Variation vs. Temperature**



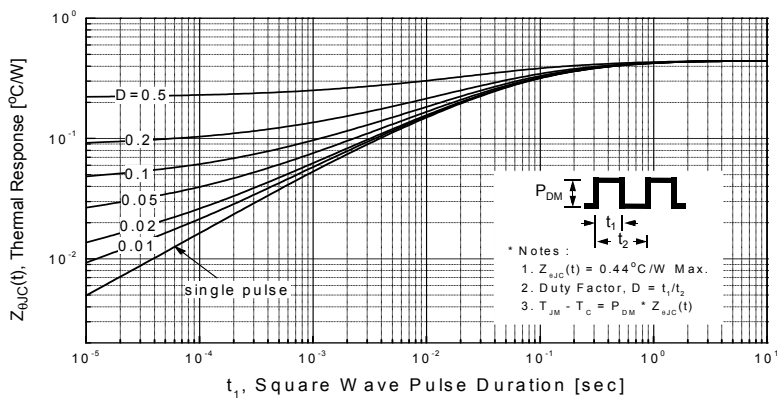
**Figure 9. Safe Operating Area**



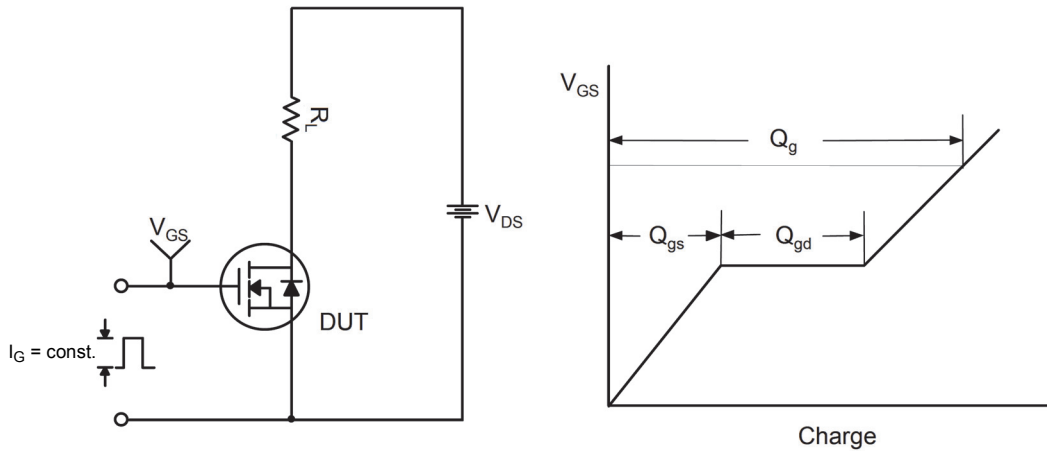
**Figure 10. Maximum Drain Current vs. Case Temperature**



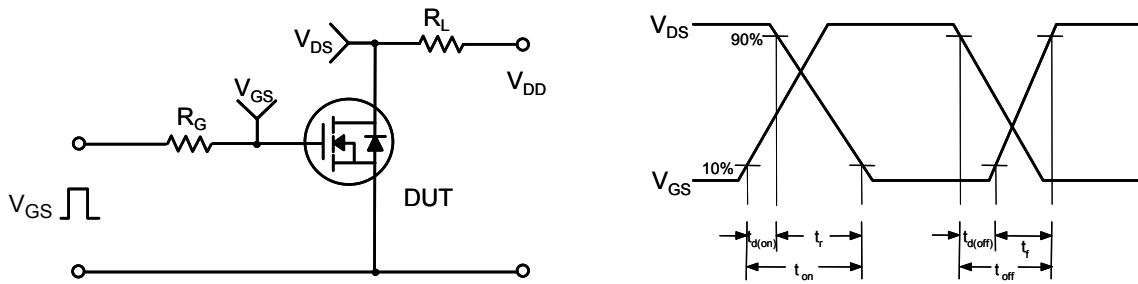
**Figure 11. Transient Thermal Response Curve**



**Figure 12. Gate Charge Test Circuit & Waveform**



**Figure 13. Resistive Switching Test Circuit & Waveforms**



**Figure 14. Unclamped Inductive Switching Test Circuit & Waveforms**

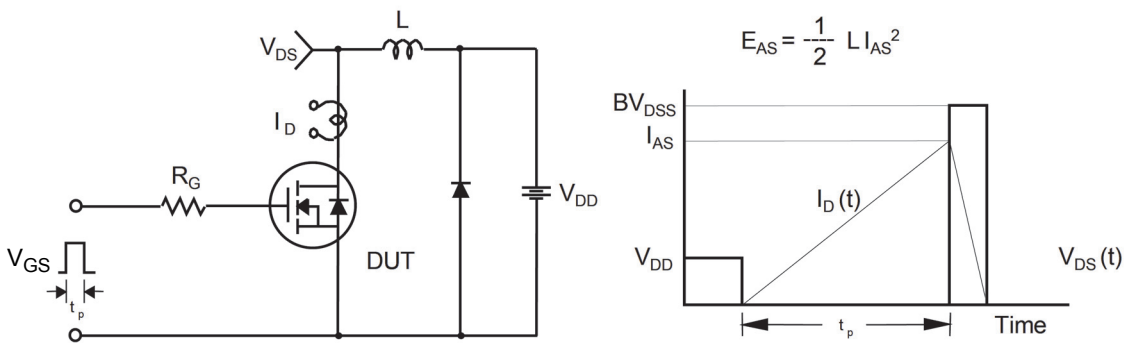
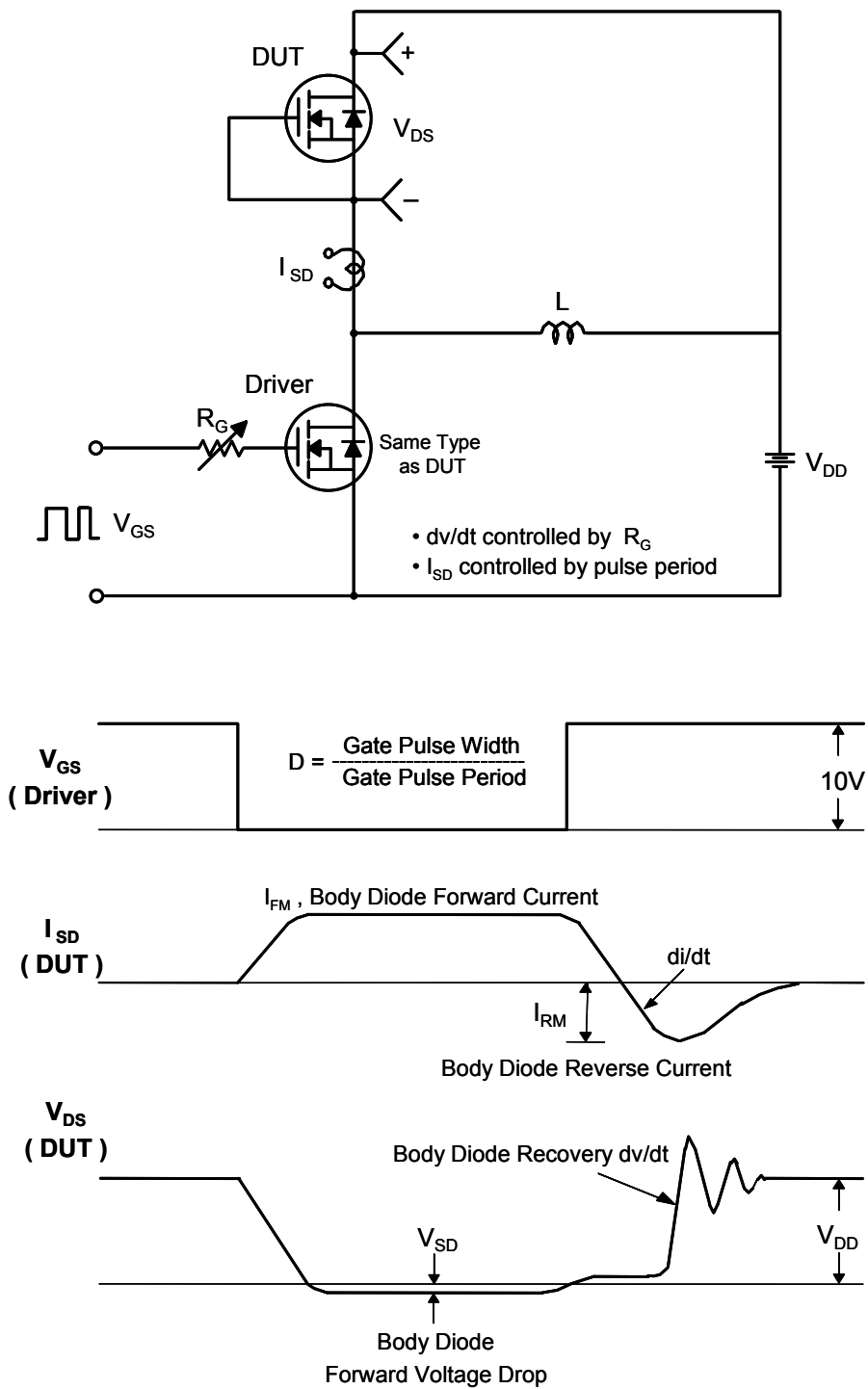


Figure 15. Peak Diode Recovery dv/dt Test Circuit & Waveforms





ON Semiconductor and  are trademarks of Semiconductor Components Industries, LLC dba ON Semiconductor or its subsidiaries in the United States and/or other countries. ON Semiconductor owns the rights to a number of patents, trademarks, copyrights, trade secrets, and other intellectual property. A listing of ON Semiconductor's product/patent coverage may be accessed at [www.onsemi.com/site/pdf/Patent-Marking.pdf](http://www.onsemi.com/site/pdf/Patent-Marking.pdf). ON Semiconductor reserves the right to make changes without further notice to any products herein. ON Semiconductor makes no warranty, representation or guarantee regarding the suitability of its products for any particular purpose, nor does ON Semiconductor assume any liability arising out of the application or use of any product or circuit, and specifically disclaims any and all liability, including without limitation special, consequential or incidental damages. Buyer is responsible for its products and applications using ON Semiconductor products, including compliance with all laws, regulations and safety requirements or standards, regardless of any support or applications information provided by ON Semiconductor. "Typical" parameters which may be provided in ON Semiconductor data sheets and/or specifications can and do vary in different applications and actual performance may vary over time. All operating parameters, including "Typicals" must be validated for each customer application by customer's technical experts. ON Semiconductor does not convey any license under its patent rights nor the rights of others. ON Semiconductor products are not designed, intended, or authorized for use as a critical component in life support systems or any FDA Class 3 medical devices or medical devices with a same or similar classification in a foreign jurisdiction or any devices intended for implantation in the human body. Should Buyer purchase or use ON Semiconductor products for any such unintended or unauthorized application, Buyer shall indemnify and hold ON Semiconductor and its officers, employees, subsidiaries, affiliates, and distributors harmless against all claims, costs, damages, and expenses, and reasonable attorney fees arising out of, directly or indirectly, any claim of personal injury or death associated with such unintended or unauthorized use, even if such claim alleges that ON Semiconductor was negligent regarding the design or manufacture of the part. ON Semiconductor is an Equal Opportunity/Affirmative Action Employer. This literature is subject to all applicable copyright laws and is not for resale in any manner.

## PUBLICATION ORDERING INFORMATION

### LITERATURE FULFILLMENT:

Literature Distribution Center for ON Semiconductor  
19521 E. 32nd Pkwy, Aurora, Colorado 80011 USA  
**Phone:** 303-675-2175 or 800-344-3860 Toll Free USA/Canada  
**Fax:** 303-675-2176 or 800-344-3867 Toll Free USA/Canada  
**Email:** [orderlit@onsemi.com](mailto:orderlit@onsemi.com)

**N. American Technical Support:** 800-282-9855 Toll Free  
USA/Canada  
**Europe, Middle East and Africa Technical Support:**  
Phone: 421 33 790 2910  
**Japan Customer Focus Center**  
Phone: 81-3-5817-1050

**ON Semiconductor Website:** [www.onsemi.com](http://www.onsemi.com)  
**Order Literature:** <http://www.onsemi.com/orderlit>  
For additional information, please contact your local  
Sales Representative