

FDD6685

30 V P-Channel POWERTRENCH[®] MOSFET

General Description

This P-Channel MOSFET is a rugged gate version of ON Semiconductor's advanced POWERTRENCH process. It has been optimized for power management applications requiring a wide range of gate drive voltage ratings (4.5 V – 2.5V).

Features

- -40 A, -30 V
 - ◆ $R_{DS(ON)} = 20\text{ m}\Omega @ V_{GS} = -10\text{ V}$
 - ◆ $R_{DS(ON)} = 30\text{ m}\Omega @ V_{GS} = -4.5\text{ V}$
- Fast Switching Speed
- High Performance Trench Technology for Extremely Low $R_{DS(ON)}$
- High Power and Current Handling Capability
- Qualified to AEC Q101
- This Device is Pb-Free and are RoHS Compliant



ON Semiconductor[®]

www.onsemi.com

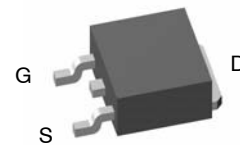
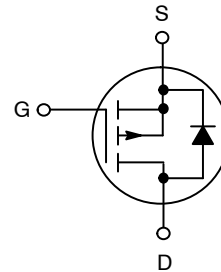

**DPAK3 (TO-252 3 LD)
CASE 369AS**

MARKING DIAGRAM

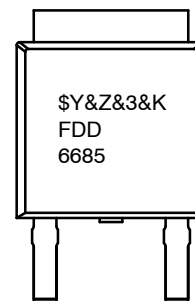

\$Y	= ON Semiconductor Logo
&Z	= Assembly Plant Code
&3	= Numeric Date Code
&K	= Lot Code
FDD6685	= Specific Device Code

ORDERING INFORMATION

See detailed ordering and shipping information on page 2 of this data sheet.

FDD6685

ABSOLUTE MAXIMUM RATINGS (T_A = 25°C, Unless otherwise noted)

Symbol	Parameter	Ratings	Units
V _{DSS}	Drain–Source Voltage	–30	V
V _{GSS}	Gate–Source Voltage	±25	V
I _D	Continuous Drain Current	@T _C = 25°C (Note 5)	–40
		@T _A = 25°C (Note 3a)	–11
		Pulsed, PW ≤ 100 μs (Note 3b)	–100
P _D	Power Dissipation for Single Operation	(Note 3)	52
		(Note 3a)	3.8
		(Note 3b)	1.6
T _J , T _{STG}	Operating and Storage Junction Temperature Range	–55 to +175	°C

Stresses exceeding those listed in the Maximum Ratings table may damage the device. If any of these limits are exceeded, device functionality should not be assumed, damage may occur and reliability may be affected.

THERMAL CHARACTERISTICS

Symbol	Parameter	Ratings	Unit
R _{θJC}	Thermal Resistance, Junction–to–Case (Note 3)	2.9	°C/W
R _{θJA}	Thermal Resistance, Junction–to–Ambient (Note 3a)	40	°C/W
R _{θJA}	Thermal Resistance, Junction–to–Ambient (Note 3b)	96	°C/W

- This product has been designed to meet the extreme test conditions and environment demanded by the automotive industry. For a copy of the requirements, see AEC Q101 at <http://www.aecouncil.com/>
- All ON Semiconductor products are manufactured, assembled and tested under ISO9000 and QS9000 quality systems certification.

PACKAGE MARKING AND ORDERING INFORMATION

Part Number	Device	Reel Size	Tape Width	Quantity
FDD6685	FDD6685	13"	16 mm	2500 Units

ELECTRICAL CHARACTERISTICS (T_A = 25°C unless otherwise noted)

Symbol	Parameter	Test Conditions	Min	Typ	Max	Unit
--------	-----------	-----------------	-----	-----	-----	------

DRAIN–SOURCE AVALANCHE RATINGS (NOTE 4)

E _{AS}	Single Pulse Drain–Source Avalanche Energy	I _D = –11 A		42		mJ
I _{AS}	Maximum Drain–Source Avalanche Current			–11		A

OFF CHARACTERISTICS

BV _{DSS}	Drain–Source Breakdown Voltage	V _{GS} = 0 V, I _D = –250 μA	–30			V
ΔBV _{DSS} / ΔT _J	Breakdown Voltage Temperature Coefficient	I _D = –250 μA, Referenced to 25°C		–24		mV/°C
I _{DSS}	Zero Gate Voltage Drain Current	V _{DS} = –24 V, V _{GS} = 0 V			–1	μA
I _{GSS}	Gate–Body Leakage	V _{GS} = ±25V, V _{DS} = 0 V			±100	nA

ON CHARACTERISTICS

V _{GS(th)}	Gate Threshold Voltage	V _{DS} = V _{GS} , I _D = –250 μA	–1	–1.8	–3	V
ΔV _{GS(th)} / ΔT _J	Gate Threshold Voltage Temperature Coefficient	I _D = –250 μA, Referenced to 25°C		5		mV/°C
R _{DS(on)}	Static Drain–Source On–Resistance	V _{GS} = –10 V, I _D = –11 A		14	20	mΩ
		V _{GS} = –4.5 V, I _D = –9 A		21	30	
		V _{GS} = –10 V, I _D = –11 A, T _J = 125°C		20		

FDD6685

ELECTRICAL CHARACTERISTICS ($T_A = 25^\circ\text{C}$ unless otherwise noted)

Symbol	Parameter	Test Conditions	Min	Typ	Max	Unit
--------	-----------	-----------------	-----	-----	-----	------

ON CHARACTERISTICS

$I_{D(on)}$	On-State Drain Current	$V_{GS} = -10\text{ V}, V_{DS} = -5\text{ V}$	-20			A
g_{FS}	Forward Transconductance	$V_{DS} = -5\text{ V}, I_D = -11\text{ A}$		26		S

DYNAMIC CHARACTERISTICS

C_{iss}	Input Capacitance	$V_{DS} = -15\text{ V}, V_{GS} = 0\text{ V}, f = 1.0\text{ MHz}$		1715		pF
C_{oss}	Output Capacitance			440		pF
C_{rss}	Reverse Transfer Capacitance			225		pF
R_G	Gate Resistance	$V_{GS} = 15\text{ mV}, f = 1.0\text{ MHz}$		3.6		Ω

SWITCHING CHARACTERISTICS

$t_{d(on)}$	Turn-On Delay Time	$V_{DD} = -15\text{ V}, I_D = -11\text{ A}, V_{GS} = -10\text{ V}, R_{GEN} = 6\ \Omega$		17	31	ns
t_r	Turn-On Rise Time			11	21	ns
$t_{d(off)}$	Turn-Off Delay Time			43	68	ns
t_f	Turn-Off Fall Time			21	34	ns
Q_g	Total Gate Charge	$V_{DS} = -15\text{ V}, I_D = -11\text{ A}, V_{GS} = -5\text{ V}$		17	24	nC
Q_{gs}	Gate-Source Charge			9		nC
Q_{gd}	Gate-Drain Charge			4		nC

DRAIN-SOURCE DIODE CHARACTERISTICS AND MAXIMUM RATINGS

V_{SD}	Drain-Source Diode Forward Voltage	$V_{GS} = 0\text{ V}, I_S = -3.2\text{ A}$ (Note 4)		-0.8	-1.2	V
T_{rr}	Diode Reverse Recovery Time	$I_F = -11\text{ A}, diF/dt = 100\text{ A}/\mu\text{s}$		26		ns
Q_{rr}	Diode Reverse Recovery Charge			13		nC

Product parametric performance is indicated in the Electrical Characteristics for the listed test conditions, unless otherwise noted. Product performance may not be indicated by the Electrical Characteristics if operated under different conditions.

NOTES:

3. $R_{\theta JA}$ is the sum of the junction-to-case and case-to-ambient thermal resistance where the case thermal reference is defined as the solder mounting surface of the drain pins. $R_{\theta JC}$ is guaranteed by design while $R_{\theta CA}$ is determined by the user's board design.



- a) $R_{\theta JA} = 40^\circ\text{C}/\text{W}$ when mounted on
 ■ 1 in^2 pad of 2 oz copper



- b) $R_{\theta JA} = 96^\circ\text{C}/\text{W}$ when mounted on
 ■ a minimum pad

4. Pulse Test: Pulse Width < 300 μs , Duty Cycle < 2.0%

5. Maximum current is calculated as:
- $$\sqrt{\frac{P_D}{R_{DS(on)}}}$$

where P_D is maximum power dissipation at $T_C = 25^\circ\text{C}$ and $R_{DS(on)}$ is at $T_{J(max)}$ and $V_{GS} = 10\text{ V}$.

6. Starting $T_J = 25^\circ\text{C}$, $L = 0.69\text{ mH}$, $I_{AS} = -11\text{ A}$

TYPICAL CHARACTERISTICS

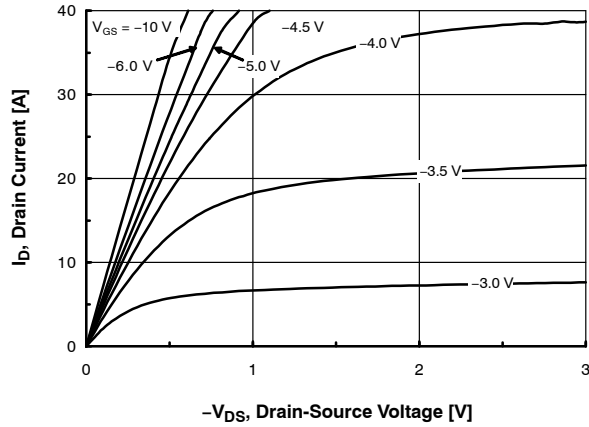

Figure 1. On-Region Characteristics

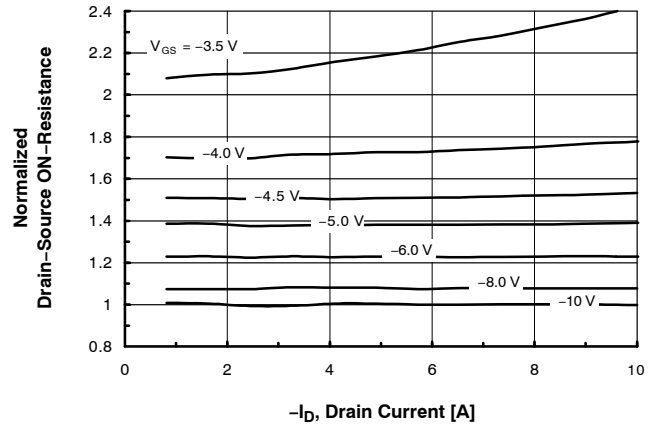

Figure 2. On-Resistance Variation with Drain Current and Gate Voltage

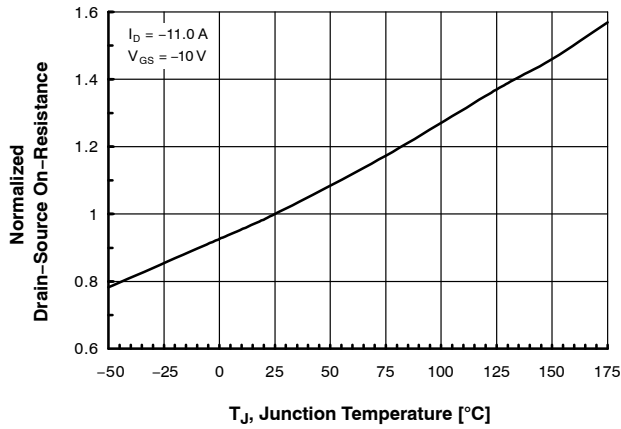

Figure 3. On-Resistance Variation with Temperature

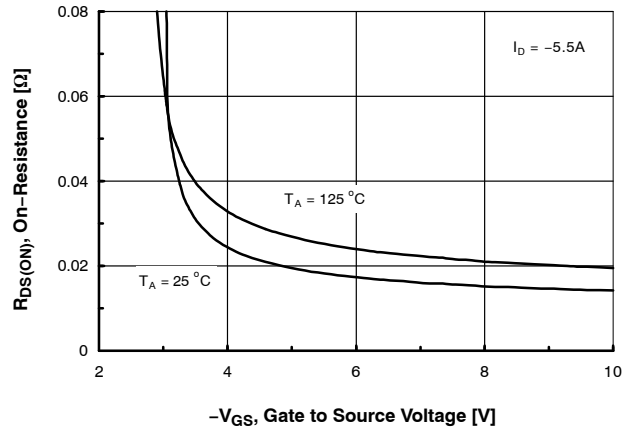

Figure 4. On-Resistance Variation with Gate-to-Source Voltage

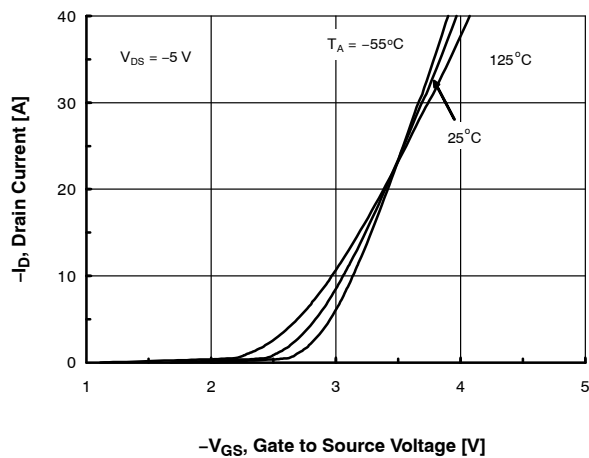

Figure 5. Transfer Characteristics

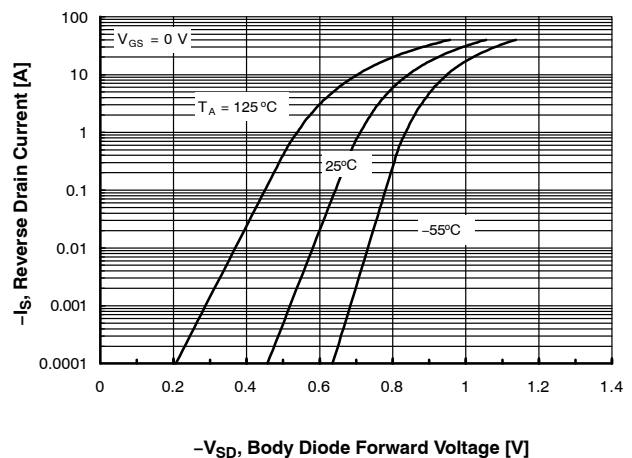

Figure 6. Body Diode Forward Voltage Variation with Source Current and Temperature

TYPICAL CHARACTERISTICS (continued)

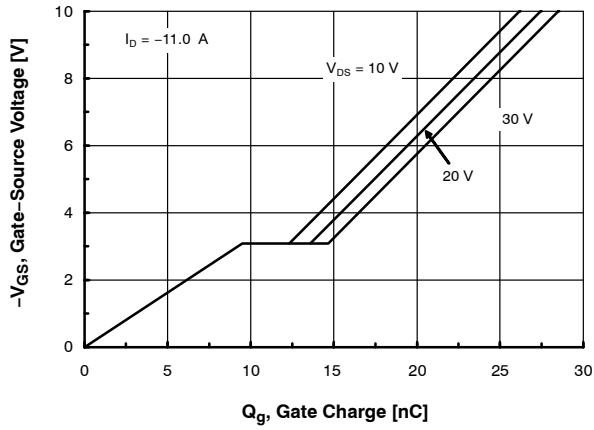

Figure 7. Gate Charge Characteristics

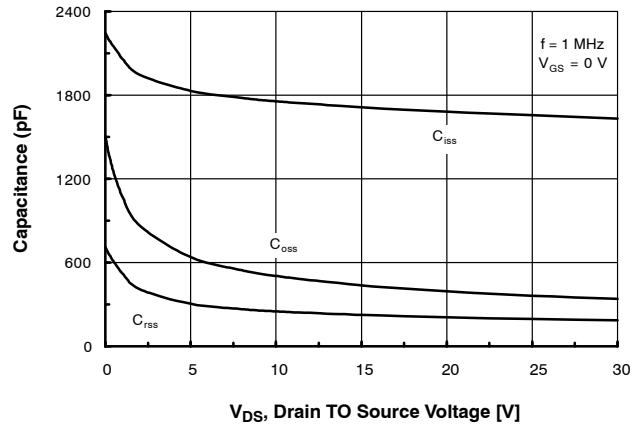

Figure 8. Capacitance Characteristics

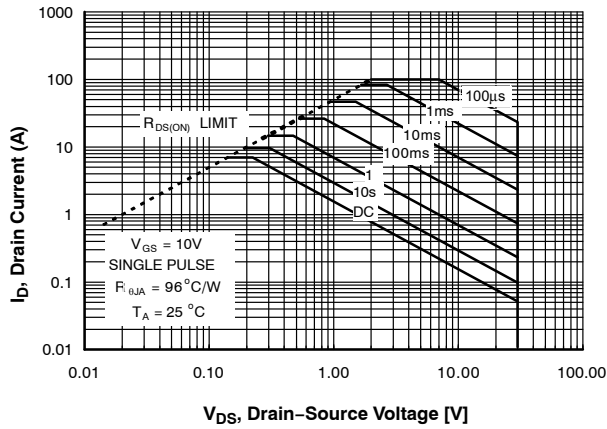

Figure 9. Maximum Safe Operating Area

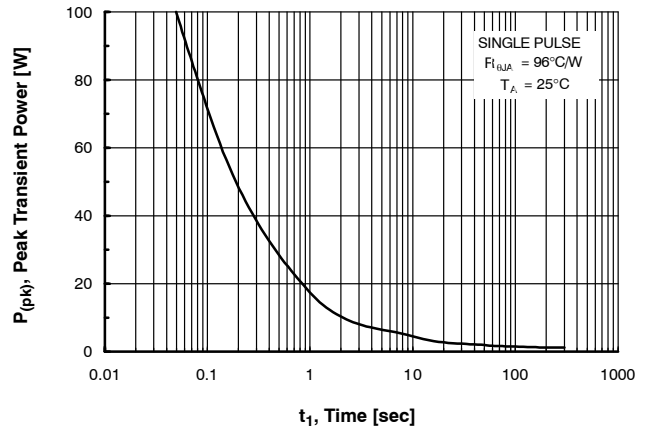

Figure 10. Single Pulse Minimum Power Dissipation

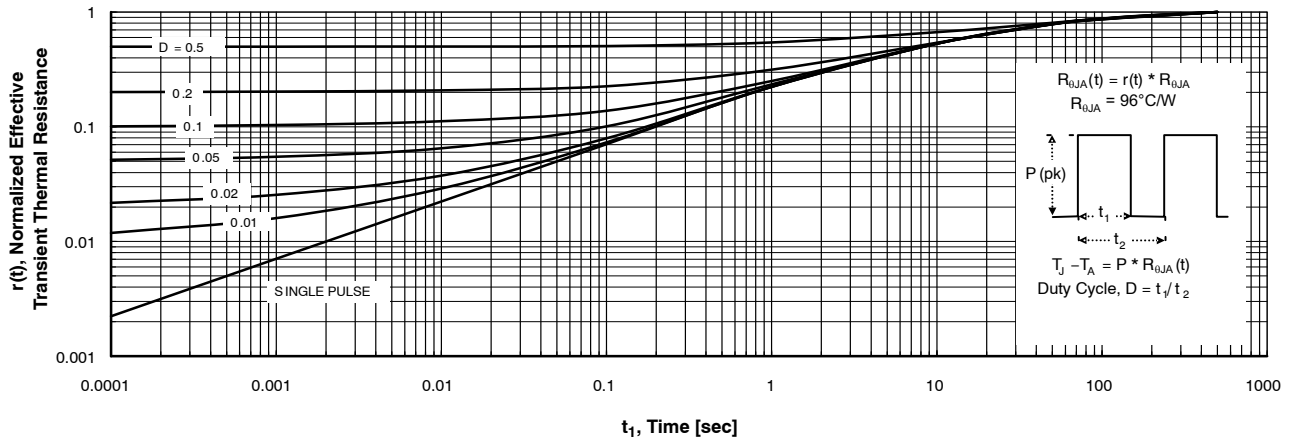

Figure 11. Transient Thermal Response Curve

NOTES:

- 7. Thermal characterization performed using the conditions described in Note 3b.
- 8. Transient thermal response will change depending on the circuit board design.

MECHANICAL CASE OUTLINE

PACKAGE DIMENSIONS

ON Semiconductor®



DPAK3 (TO-252 3 LD)

CASE 369AS

ISSUE O

DATE 30 SEP 2016

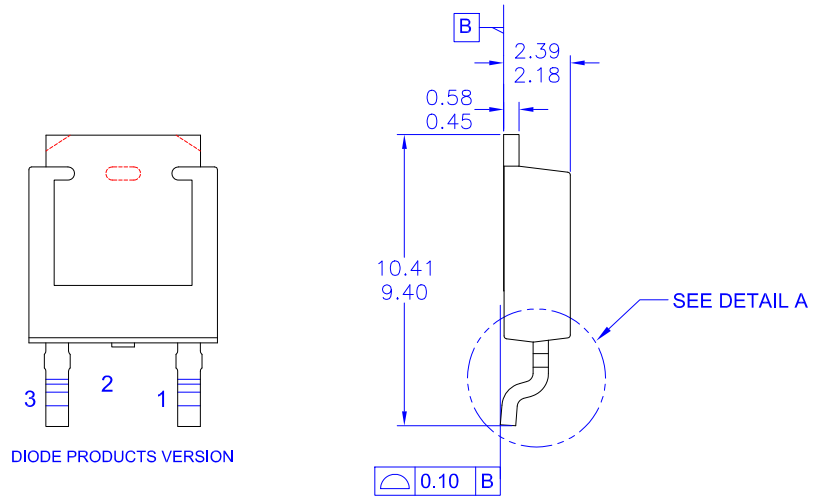
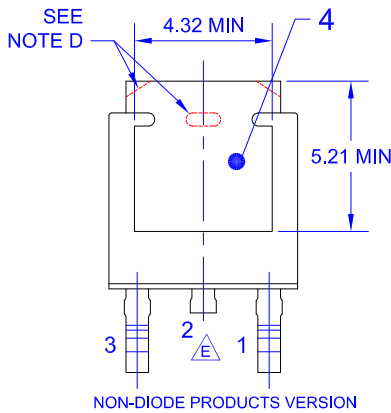
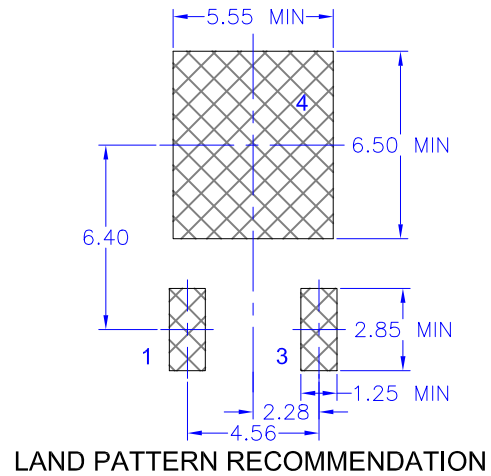
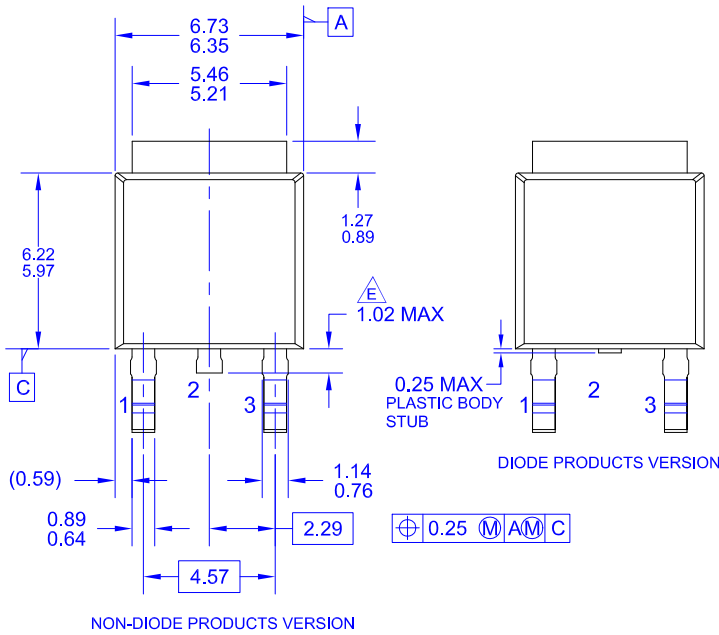

- NOTES: UNLESS OTHERWISE SPECIFIED
- A) THIS PACKAGE CONFORMS TO JEDEC, TO-252, ISSUE C, VARIATION AA.
 - B) ALL DIMENSIONS ARE IN MILLIMETERS.
 - C) DIMENSIONING AND TOLERANCING PER ASME Y14.5M-2009.
 - D) SUPPLIER DEPENDENT MOLD LOCKING HOLES OR CHAMFERED CORNERS OR EDGE PROTRUSION.
 - E) TRIMMED CENTER LEAD IS PRESENT ONLY FOR DIODE PRODUCTS
 - F) DIMENSIONS ARE EXCLUSIVE OF BURRS, MOLD FLASH AND TIE BAR EXTRUSIONS.
 - G) LAND PATTERN RECOMMENDATION IS BASED ON IPC7351A STD TO228P991X239-3N.

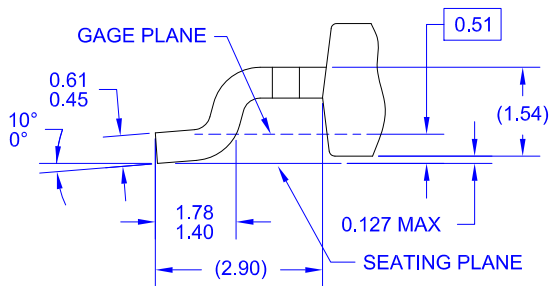

DOCUMENT NUMBER:	98AON13810G	Electronic versions are uncontrolled except when accessed directly from the Document Repository. Printed versions are uncontrolled except when stamped "CONTROLLED COPY" in red.
STATUS:	ON SEMICONDUCTOR STANDARD	
NEW STANDARD:		
DESCRIPTION:	DPAK3 (TO-252 3 LD)	PAGE 1 OF 2



ISSUE	REVISION	DATE
0	RELEASED FOR PRODUCTION FROM FAIRCHILD TO263A03 TO ON SEMICONDUCTOR. REQ. BY I. CAMBALIZA.	30 SEP 2016

ON Semiconductor and  are registered trademarks of Semiconductor Components Industries, LLC (SCILLC). SCILLC reserves the right to make changes without further notice to any products herein. SCILLC makes no warranty, representation or guarantee regarding the suitability of its products for any particular purpose, nor does SCILLC assume any liability arising out of the application or use of any product or circuit, and specifically disclaims any and all liability, including without limitation special, consequential or incidental damages. "Typical" parameters which may be provided in SCILLC data sheets and/or specifications can and do vary in different applications and actual performance may vary over time. All operating parameters, including "Typicals" must be validated for each customer application by customer's technical experts. SCILLC does not convey any license under its patent rights nor the rights of others. SCILLC products are not designed, intended, or authorized for use as components in systems intended for surgical implant into the body, or other applications intended to support or sustain life, or for any other application in which the failure of the SCILLC product could create a situation where personal injury or death may occur. Should Buyer purchase or use SCILLC products for any such unintended or unauthorized application, Buyer shall indemnify and hold SCILLC and its officers, employees, subsidiaries, affiliates, and distributors harmless against all claims, costs, damages, and expenses, and reasonable attorney fees arising out of, directly or indirectly, any claim of personal injury or death associated with such unintended or unauthorized use, even if such claim alleges that SCILLC was negligent regarding the design or manufacture of the part. SCILLC is an Equal Opportunity/Affirmative Action Employer. This literature is subject to all applicable copyright laws and is not for resale in any manner.

ON Semiconductor and  are trademarks of Semiconductor Components Industries, LLC dba ON Semiconductor or its subsidiaries in the United States and/or other countries. ON Semiconductor owns the rights to a number of patents, trademarks, copyrights, trade secrets, and other intellectual property. A listing of ON Semiconductor's product/patent coverage may be accessed at www.onsemi.com/site/pdf/Patent-Marking.pdf. ON Semiconductor reserves the right to make changes without further notice to any products herein. ON Semiconductor makes no warranty, representation or guarantee regarding the suitability of its products for any particular purpose, nor does ON Semiconductor assume any liability arising out of the application or use of any product or circuit, and specifically disclaims any and all liability, including without limitation special, consequential or incidental damages. Buyer is responsible for its products and applications using ON Semiconductor products, including compliance with all laws, regulations and safety requirements or standards, regardless of any support or applications information provided by ON Semiconductor. "Typical" parameters which may be provided in ON Semiconductor data sheets and/or specifications can and do vary in different applications and actual performance may vary over time. All operating parameters, including "Typicals" must be validated for each customer application by customer's technical experts. ON Semiconductor does not convey any license under its patent rights nor the rights of others. ON Semiconductor products are not designed, intended, or authorized for use as a critical component in life support systems or any FDA Class 3 medical devices or medical devices with a same or similar classification in a foreign jurisdiction or any devices intended for implantation in the human body. Should Buyer purchase or use ON Semiconductor products for any such unintended or unauthorized application, Buyer shall indemnify and hold ON Semiconductor and its officers, employees, subsidiaries, affiliates, and distributors harmless against all claims, costs, damages, and expenses, and reasonable attorney fees arising out of, directly or indirectly, any claim of personal injury or death associated with such unintended or unauthorized use, even if such claim alleges that ON Semiconductor was negligent regarding the design or manufacture of the part. ON Semiconductor is an Equal Opportunity/Affirmative Action Employer. This literature is subject to all applicable copyright laws and is not for resale in any manner.

PUBLICATION ORDERING INFORMATION

LITERATURE FULFILLMENT:

Literature Distribution Center for ON Semiconductor
19521 E. 32nd Pkwy, Aurora, Colorado 80011 USA
Phone: 303-675-2175 or 800-344-3860 Toll Free USA/Canada
Fax: 303-675-2176 or 800-344-3867 Toll Free USA/Canada
Email: orderlit@onsemi.com

N. American Technical Support: 800-282-9855 Toll Free
USA/Canada
Europe, Middle East and Africa Technical Support:
Phone: 421 33 790 2910

ON Semiconductor Website: www.onsemi.com

Order Literature: <http://www.onsemi.com/orderlit>

For additional information, please contact your local
Sales Representative