

# FDMA8051L

## MOSFET, Single N-Channel, POWERTRENCH®

40 V, 10 A, 14 mΩ

### General Description

This device has been designed to provide maximum efficiency and thermal performance for synchronous buck converters. The low  $r_{DS(on)}$  and gate charge provide excellent switching performance.

### Features

- Max  $r_{DS(on)}$  = 14 mΩ at  $V_{GS} = 10\text{ V}$ ,  $I_D = 10\text{ A}$
- Max  $r_{DS(on)}$  = 18 mΩ at  $V_{GS} = 4.5\text{ V}$ ,  $I_D = 8.5\text{ A}$
- Low Profile – 0.8 mm maximum in the new package MicroFET 2 x 2 mm
- Free from halogenated compounds and antimony oxides
- RoHS Compliant

### Application

- DC-DC Buck Converters

### MOSFET MAXIMUM RATINGS ( $T_A = 25^\circ\text{C}$ unless otherwise noted)

Symbol	Parameter	Ratings	Unit
$V_{DS}$	Drain to Source Voltage	40	V
$V_{GS}$	Gate to Source Voltage	$\pm 20$	V
$I_D$	Drain Current – Continuous $T_A = 25^\circ\text{C}$ (Note 1a)	10	A
	– Pulsed (Note 3)	80	
$P_D$	Power dissipation $T_A = 25^\circ\text{C}$ (Note 1a)	2.4	W
	Power dissipation $T_A = 25^\circ\text{C}$ (Note 1b)	0.9	
$T_J$ , $T_{STG}$	Operating and Storage Junction Temperature Range	-55 to +150	$^\circ\text{C}$

Stresses exceeding those listed in the Maximum Ratings table may damage the device. If any of these limits are exceeded, device functionality should not be assumed, damage may occur and reliability may be affected.

### THERMAL CHARACTERISTICS

Symbol	Parameter	Ratings	Unit
$R_{\theta JA}$	Thermal Resistance, Junction to Ambient (Note 1a)	52	$^\circ\text{C/W}$
$R_{\theta JA}$	Thermal Resistance, Junction to Ambient (Note 1b)	145	

### PACKAGE MARKING AND ORDERING INFORMATION

Device Marking	Device	Package	Shipping†
051	FDMA8051L	MicroFET 2x2	3000 Units/ Tape & Reel

†For information on tape and reel specifications, including part orientation and tape sizes, please refer to our Tape and Reel Packaging Specifications Brochure, BRD8011/D.



ON Semiconductor®

[www.onsemi.com](http://www.onsemi.com)

### ELECTRICAL CONNECTION

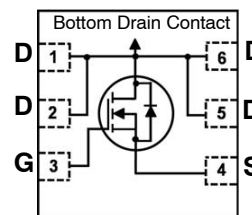

Single N-Channel MOSFET

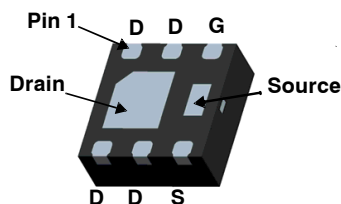

MicroFET 2x2  
(WDFN6 2x2, 0.65P)  
CASE 511DB

### MARKING DIAGRAM

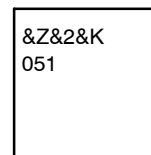

&Z = Assembly Plant Code  
&2 = Numeric Date Code  
&K = Lot Code  
051 = Specific Device Code

### ORDERING INFORMATION

See detailed ordering and shipping information on page 1 of this data sheet.

# FDMA8051L

## ELECTRICAL CHARACTERISTICS (T<sub>J</sub> = 25°C unless otherwise noted)

Symbol	Parameter	Test Condition	Min	Typ	Max	Unit
<b>OFF CHARACTERISTICS</b>						
BV <sub>DSS</sub>	Drain to Source Breakdown Voltage	I <sub>D</sub> = 250 μA, V <sub>GS</sub> = 0 V	40			V
$\frac{\Delta BV_{DSS}}{\Delta T_J}$	Breakdown Voltage Temperature Coefficient	I <sub>D</sub> = 250 μA, referenced to 25°C		22		mV/°C
I <sub>DSS</sub>	Zero Gate Voltage Drain Current	V <sub>DS</sub> = 32 V, V <sub>GS</sub> = 0 V			1	μA
I <sub>GSS</sub>	Gate-to-Source Leakage Current	V <sub>GS</sub> = ±20 V, V <sub>DS</sub> = 0 V			100	nA

## ON CHARACTERISTICS

V <sub>GS(th)</sub>	Gate to Source Threshold Voltage	V <sub>GS</sub> = V <sub>DS</sub> , I <sub>D</sub> = 250 μA	1.0	1.6	3.0	V
$\frac{\Delta V_{GS(th)}}{\Delta T_J}$	Gate to Source Threshold Voltage Temperature Coefficient	I <sub>D</sub> = 250 μA, referenced to 25°C		-5		mV/°C
r <sub>DS(on)</sub>	Static Drain to Source On Resistance	V <sub>GS</sub> = 10 V, I <sub>D</sub> = 10 A		11	14	mΩ
		V <sub>GS</sub> = 4.5 V, I <sub>D</sub> = 8.5 A		14	18	
		V <sub>GS</sub> = 10 V, I <sub>D</sub> = 10 A, T <sub>J</sub> = 125°C		15	19	
g <sub>FS</sub>	Forward Transconductance	V <sub>DD</sub> = 5 V, I <sub>D</sub> = 10 A		35		S

## DYNAMIC CHARACTERISTICS

C <sub>iss</sub>	Input Capacitance	V <sub>DS</sub> = 20 V, V <sub>GS</sub> = 0 V, f = 1MHz		901	1260	pF
C <sub>oss</sub>	Output Capacitance			251	350	
C <sub>rss</sub>	Reverse Transfer Capacitance			16	25	
R <sub>g</sub>	Gate Resistance		0.1	0.6	1.8	Ω

## SWITCHING CHARACTERISTICS

td(on)	Turn – On Delay Time	V <sub>DD</sub> = 20 V, I <sub>D</sub> = 10 A, V <sub>GS</sub> = 10 V, R <sub>GEN</sub> = 6 Ω		6.4	13	ns
t <sub>r</sub>	Rise Time			1.8	10	
t <sub>D(off)</sub>	Turn – Off Delay Time			17	31	
t <sub>f</sub>	Fall Time			1.8	10	
Q <sub>g</sub>	Total Gate Charge	V <sub>GS</sub> = 0V to 10 V  V <sub>DD</sub> = 20 V, I <sub>D</sub> = 10 A		14	20	nC
Q <sub>g</sub>	Total Gate Charge			6.4	9.0	
Q <sub>gs</sub>	Total Gate Charge			2.4	3.7	
Q <sub>gd</sub>	Gate to Source Charge			1.8	2.5	

## DRAIN-SOURCE DIODE CHARACTERISTICS

V <sub>SD</sub>	Source to Drain Diode Forward Voltage	V <sub>GS</sub> = 0 V, I <sub>S</sub> = 2 A (Note 2)		0.7	1.2	V
		V <sub>GS</sub> = 0 V, I <sub>S</sub> = 10 A (Note 2)		0.8	1.2	
t <sub>rr</sub>	Reverse Recovery Time	I <sub>F</sub> = 10 A, di/dt = 100 A/μs		23	37	ns
Q <sub>rr</sub>	Reverse Recovery Charge			6.7	14	nC

Product parametric performance is indicated in the Electrical Characteristics for the listed test conditions, unless otherwise noted. Product performance may not be indicated by the Electrical Characteristics if operated under different conditions.

NOTES:

1.  $R_{\theta JA}$  is determined with the device mounted on a 1 in<sup>2</sup> pad 2 oz copper pad on a 1.5 × 1.5 in. board of FR-4 material.  $R_{\theta JC}$  is guaranteed by design while  $R_{\theta JA}$  is determined by the user's board design.

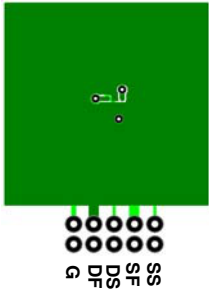

a) 52°C/W when mounted on a 1 in<sup>2</sup> pad of 2 oz copper.



b) 145°C/W when mounted on a minimum pad of 2 oz copper.

2. Pulse Test: Pulse Width < 300 μs, Duty cycle < 2.0%.
3. Pulsed  $I_D$  limited by junction temperature,  $t_{d} \leq 100 \mu s$ , please refer to SOA curve for more details.

TYPICAL CHARACTERISTICS  $T_J = 25^\circ C$  unless otherwise noted

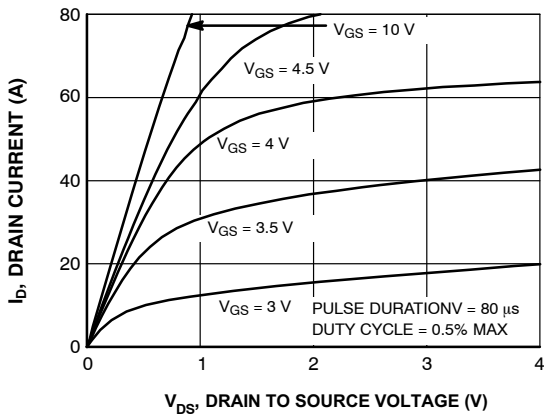

Figure 1. On Region Characteristics

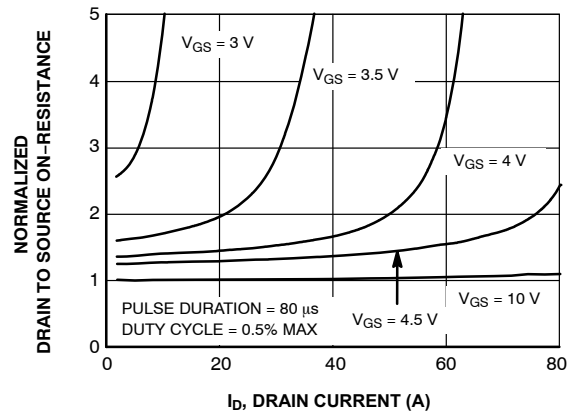

Figure 2. Normalized On-Resistance vs. Drain Current and Gate Voltage

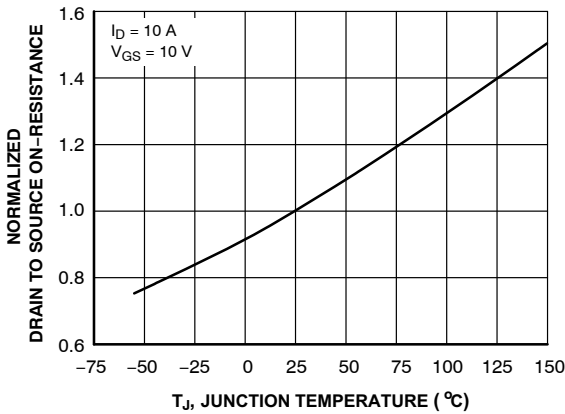

Figure 3. Normalized On Resistance vs. Junction Temperature

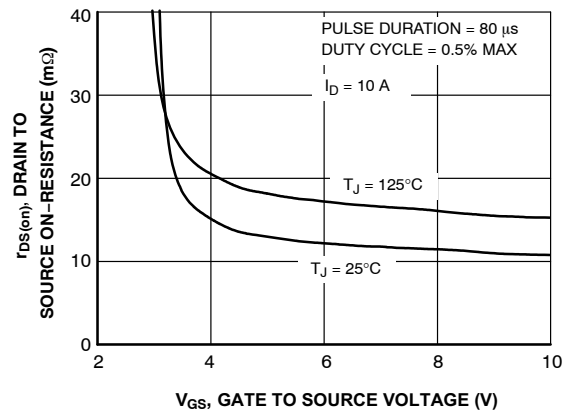

Figure 4. On-Resistance vs. Gate to Source Voltage

TYPICAL CHARACTERISTICS  $T_J = 25^\circ\text{C}$  unless otherwise noted (continued)

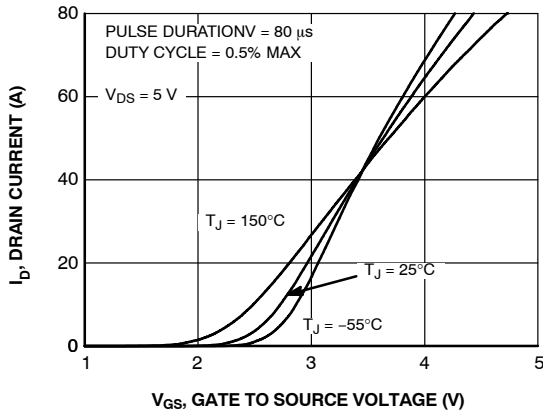

Figure 5. Transfer Characteristics

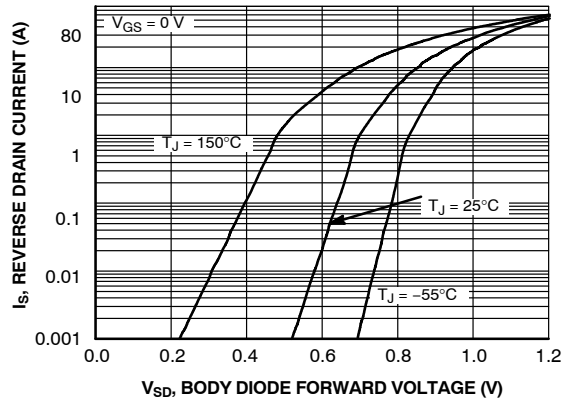

Figure 6. Source to Drain Diode Forward Voltage vs. Source Current

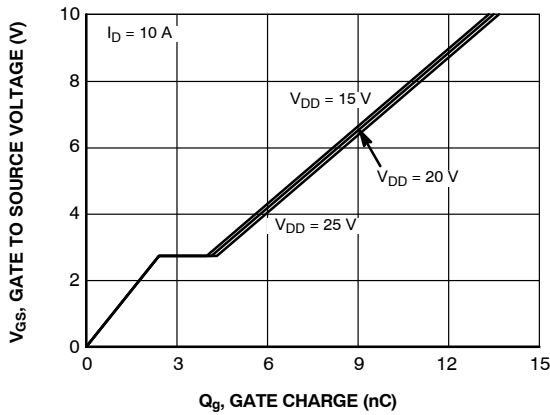

Figure 7. Gate Charge Characteristics

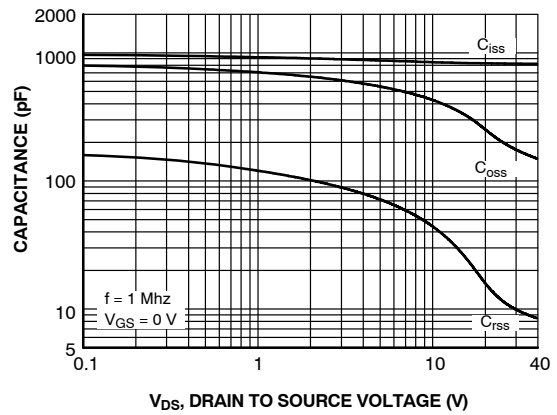

Figure 8. Capacitance vs. Drain to Source Voltage

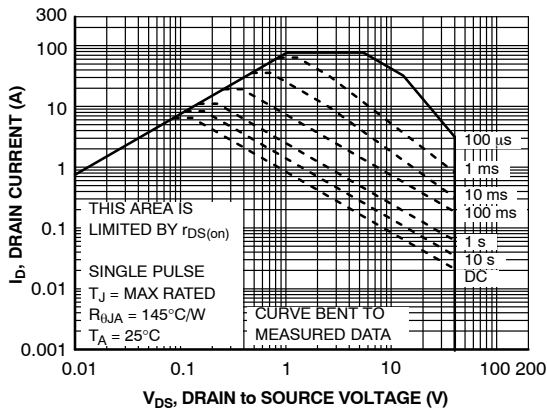

Figure 9. Forward Bias Safe Operating Area

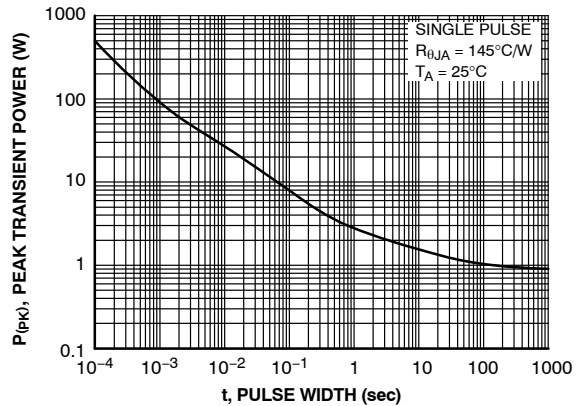

Figure 10. Single Pulse Maximum Power Dissipation

TYPICAL CHARACTERISTICS  $T_J = 25^\circ\text{C}$  unless otherwise noted (continued)

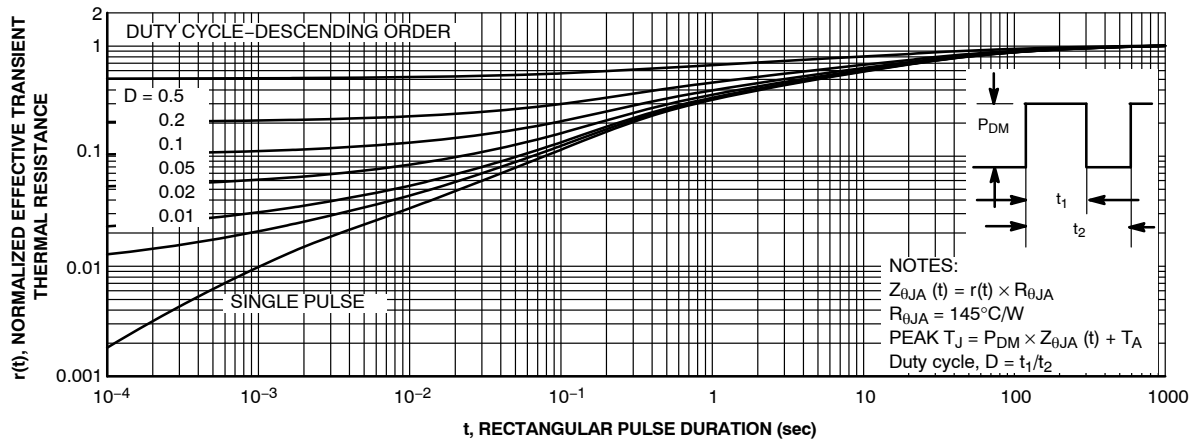
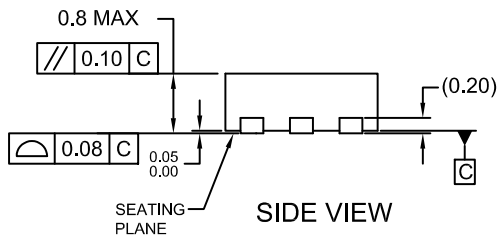
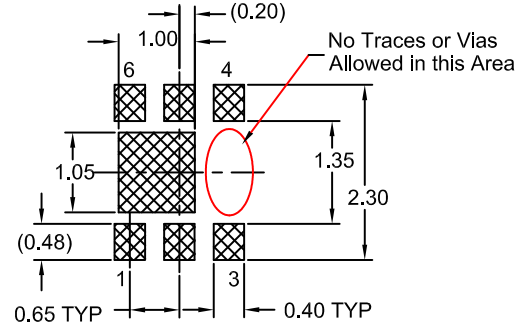
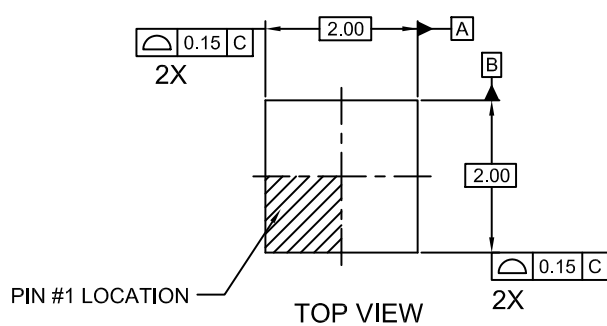

Figure 11. Single Pulse Junction-to-Ambient Transient Thermal Response Curve

POWERTRENCH is registered trademark of Semiconductor Components Industries, LLC (SCILLC) or its subsidiaries in the United States and/or other countries.

**WDFN6 2x2, 0.65P**  
**CASE 511DB**  
**ISSUE O**

DATE 31 AUG 2016



RECOMMENDED LAND PATTERN OPT 1

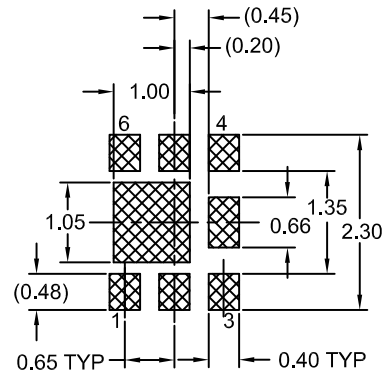
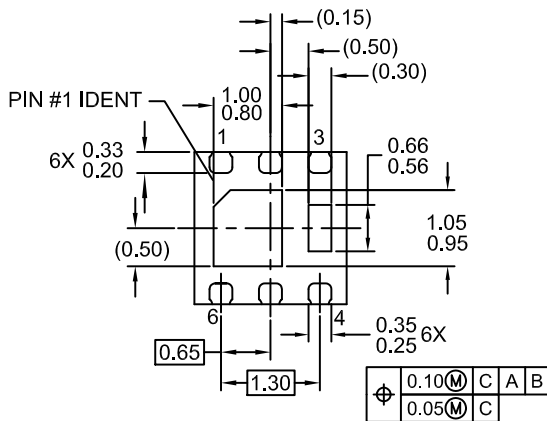

BOTTOM VIEW

RECOMMENDED LAND PATTERN OPT 2

**NOTES:**

- A. DOES NOT FULLY CONFORM TO JEDEC REGISTRATION MO-229 DATED AUG/2003
- B. DIMENSIONS ARE IN MILLIMETERS.
- C. DIMENSIONS AND TOLERANCES PER ASME Y14.5M, 1994

<b>DOCUMENT NUMBER:</b>	<b>98AON13617G</b>	Electronic versions are uncontrolled except when accessed directly from the Document Repository. Printed versions are uncontrolled except when stamped "CONTROLLED COPY" in red.
<b>STATUS:</b>	<b>ON SEMICONDUCTOR STANDARD</b>	
<b>NEW STANDARD:</b>		
<b>DESCRIPTION:</b>	<b>WDFN6 2X2, 0.65P</b>	<b>PAGE 1 OF 2</b>



ON Semiconductor and  are trademarks of Semiconductor Components Industries, LLC dba ON Semiconductor or its subsidiaries in the United States and/or other countries. ON Semiconductor owns the rights to a number of patents, trademarks, copyrights, trade secrets, and other intellectual property. A listing of ON Semiconductor's product/patent coverage may be accessed at [www.onsemi.com/site/pdf/Patent-Marking.pdf](http://www.onsemi.com/site/pdf/Patent-Marking.pdf). ON Semiconductor reserves the right to make changes without further notice to any products herein. ON Semiconductor makes no warranty, representation or guarantee regarding the suitability of its products for any particular purpose, nor does ON Semiconductor assume any liability arising out of the application or use of any product or circuit, and specifically disclaims any and all liability, including without limitation special, consequential or incidental damages. Buyer is responsible for its products and applications using ON Semiconductor products, including compliance with all laws, regulations and safety requirements or standards, regardless of any support or applications information provided by ON Semiconductor. "Typical" parameters which may be provided in ON Semiconductor data sheets and/or specifications can and do vary in different applications and actual performance may vary over time. All operating parameters, including "Typicals" must be validated for each customer application by customer's technical experts. ON Semiconductor does not convey any license under its patent rights nor the rights of others. ON Semiconductor products are not designed, intended, or authorized for use as a critical component in life support systems or any FDA Class 3 medical devices or medical devices with a same or similar classification in a foreign jurisdiction or any devices intended for implantation in the human body. Should Buyer purchase or use ON Semiconductor products for any such unintended or unauthorized application, Buyer shall indemnify and hold ON Semiconductor and its officers, employees, subsidiaries, affiliates, and distributors harmless against all claims, costs, damages, and expenses, and reasonable attorney fees arising out of, directly or indirectly, any claim of personal injury or death associated with such unintended or unauthorized use, even if such claim alleges that ON Semiconductor was negligent regarding the design or manufacture of the part. ON Semiconductor is an Equal Opportunity/Affirmative Action Employer. This literature is subject to all applicable copyright laws and is not for resale in any manner.

## PUBLICATION ORDERING INFORMATION

### LITERATURE FULFILLMENT:

Literature Distribution Center for ON Semiconductor  
19521 E. 32nd Pkwy, Aurora, Colorado 80011 USA  
**Phone:** 303-675-2175 or 800-344-3860 Toll Free USA/Canada  
**Fax:** 303-675-2176 or 800-344-3867 Toll Free USA/Canada  
**Email:** [orderlit@onsemi.com](mailto:orderlit@onsemi.com)

**N. American Technical Support:** 800-282-9855 Toll Free  
USA/Canada  
**Europe, Middle East and Africa Technical Support:**  
Phone: 421 33 790 2910

**ON Semiconductor Website:** [www.onsemi.com](http://www.onsemi.com)

**Order Literature:** <http://www.onsemi.com/orderlit>

For additional information, please contact your local  
Sales Representative