



Is Now Part of



ON Semiconductor®

To learn more about ON Semiconductor, please visit our website at
www.onsemi.com

Please note: As part of the Fairchild Semiconductor integration, some of the Fairchild orderable part numbers will need to change in order to meet ON Semiconductor's system requirements. Since the ON Semiconductor product management systems do not have the ability to manage part nomenclature that utilizes an underscore (_), the underscore (_) in the Fairchild part numbers will be changed to a dash (-). This document may contain device numbers with an underscore (_). Please check the ON Semiconductor website to verify the updated device numbers. The most current and up-to-date ordering information can be found at www.onsemi.com. Please email any questions regarding the system integration to Fairchild_questions@onsemi.com.

ON Semiconductor and the ON Semiconductor logo are trademarks of Semiconductor Components Industries, LLC dba ON Semiconductor or its subsidiaries in the United States and/or other countries. ON Semiconductor owns the rights to a number of patents, trademarks, copyrights, trade secrets, and other intellectual property. A listing of ON Semiconductor's product/patent coverage may be accessed at www.onsemi.com/site/pdf/Patent-Marking.pdf. ON Semiconductor reserves the right to make changes without further notice to any products herein. ON Semiconductor makes no warranty, representation or guarantee regarding the suitability of its products for any particular purpose, nor does ON Semiconductor assume any liability arising out of the application or use of any product or circuit, and specifically disclaims any and all liability, including without limitation special, consequential or incidental damages. Buyer is responsible for its products and applications using ON Semiconductor products, including compliance with all laws, regulations and safety requirements or standards, regardless of any support or applications information provided by ON Semiconductor. "Typical" parameters which may be provided in ON Semiconductor data sheets and/or specifications can and do vary in different applications and actual performance may vary over time. All operating parameters, including "Typicals" must be validated for each customer application by customer's technical experts. ON Semiconductor does not convey any license under its patent rights nor the rights of others. ON Semiconductor products are not designed, intended, or authorized for use as a critical component in life support systems or any FDA Class 3 medical devices or medical devices with a same or similar classification in a foreign jurisdiction or any devices intended for implantation in the human body. Should Buyer purchase or use ON Semiconductor products for any such unintended or unauthorized application, Buyer shall indemnify and hold ON Semiconductor and its officers, employees, subsidiaries, affiliates, and distributors harmless against all claims, costs, damages, and expenses, and reasonable attorney fees arising out of, directly or indirectly, any claim of personal injury or death associated with such unintended or unauthorized use, even if such claim alleges that ON Semiconductor was negligent regarding the design or manufacture of the part. ON Semiconductor is an Equal Opportunity/Affirmative Action Employer. This literature is subject to all applicable copyright laws and is not for resale in any manner.



FDMC8200

Dual N-Channel PowerTrench[®] MOSFET 30 V, 9.5 mΩ and 20 mΩ

Features

Q1: N-Channel

- Max $r_{DS(on)}$ = 20 mΩ at $V_{GS} = 10\text{ V}$, $I_D = 6\text{ A}$
- Max $r_{DS(on)}$ = 32 mΩ at $V_{GS} = 4.5\text{ V}$, $I_D = 5\text{ A}$

Q2: N-Channel

- Max $r_{DS(on)}$ = 9.5 mΩ at $V_{GS} = 10\text{ V}$, $I_D = 9\text{ A}$
- Max $r_{DS(on)}$ = 13.5 mΩ at $V_{GS} = 4.5\text{ V}$, $I_D = 7\text{ A}$
- RoHS Compliant

General Description

This device includes two specialized N-Channel MOSFETs in a dual Power33 (3mm x 3mm MLP) package. The switch node has been internally connected to enable easy placement and routing of synchronous buck converters. The control MOSFET (Q1) and synchronous MOSFET (Q2) have been designed to provide optimal power efficiency.

Applications

- Mobile Computing
- Mobile Internet Devices
- General Purpose Point of Load

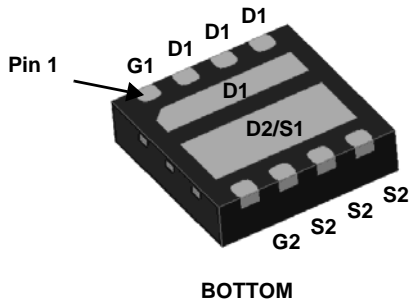

BOTTOM

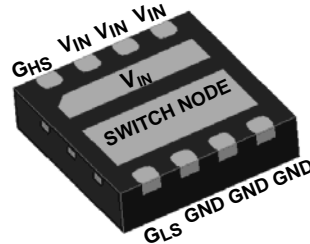

BOTTOM

Power 33

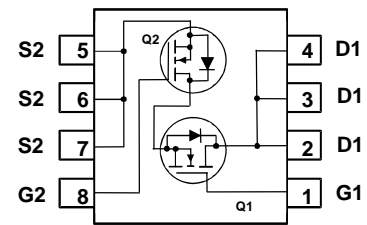

MOSFET Maximum Ratings $T_C = 25\text{ °C}$ unless otherwise noted

Symbol	Parameter	Q1	Q2	Units
V_{DS}	Drain to Source Voltage	30	30	V
V_{GS}	Gate to Source Voltage (Note 3)	± 20	± 20	V
I_D	Drain Current - Continuous (Package limited)	$T_C = 25\text{ °C}$	18	18
	- Continuous (Silicon limited)	$T_C = 25\text{ °C}$	23	45
	- Continuous	$T_A = 25\text{ °C}$	8 ^{1a}	12 ^{1b}
	- Pulsed		40	40
P_D	Power Dissipation	$T_A = 25\text{ °C}$	1.9 ^{1a}	2.2 ^{1b}
	Power Dissipation	$T_A = 25\text{ °C}$	0.7 ^{1c}	0.9 ^{1d}
T_J, T_{STG}	Operating and Storage Junction Temperature Range	-55 to +150		°C

Thermal Characteristics

$R_{\theta JA}$	Thermal Resistance, Junction to Ambient	65 ^{1a}	55 ^{1b}	°C/W
$R_{\theta JA}$	Thermal Resistance, Junction to Ambient	180 ^{1c}	145 ^{1d}	
$R_{\theta JC}$	Thermal Resistance, Junction to Case	7.5	4	

Package Marking and Ordering Information

Device Marking	Device	Package	Reel Size	Tape Width	Quantity
FDMC8200	FDMC8200	Power 33	13"	12 mm	3000 units

Electrical Characteristics $T_J = 25\text{ }^\circ\text{C}$ unless otherwise noted

Symbol	Parameter	Test Conditions	Type	Min	Typ	Max	Units
--------	-----------	-----------------	------	-----	-----	-----	-------

Off Characteristics

BV_{DSS}	Drain to Source Breakdown Voltage	$I_D = 250\text{ }\mu\text{A}, V_{GS} = 0\text{ V}$ $I_D = 250\text{ }\mu\text{A}, V_{GS} = 0\text{ V}$	Q1 Q2	30 30			V
$\frac{\Delta BV_{DSS}}{\Delta T_J}$	Breakdown Voltage Temperature Coefficient	$I_D = 250\text{ }\mu\text{A}$, referenced to $25\text{ }^\circ\text{C}$ $I_D = 250\text{ }\mu\text{A}$, referenced to $25\text{ }^\circ\text{C}$	Q1 Q2		14 14		mV/ $^\circ\text{C}$
I_{DSS}	Zero Gate Voltage Drain Current	$V_{DS} = 24\text{ V}, V_{GS} = 0\text{ V}$ $V_{DS} = 24\text{ V}, V_{GS} = 0\text{ V}$	Q1 Q2			1 1	μA
I_{GSS}	Gate to Source Leakage Current	$V_{DS} = 20\text{ V}, V_{GS} = 0\text{ V}$	Q1 Q2			100 100	nA nA

On Characteristics

$V_{GS(th)}$	Gate to Source Threshold Voltage	$V_{GS} = V_{DS}, I_D = 250\text{ }\mu\text{A}$ $V_{GS} = V_{DS}, I_D = 250\text{ }\mu\text{A}$	Q1 Q2	1.0 1.0	2.3 2.3	3.0 3.0	V
$\frac{\Delta V_{GS(th)}}{\Delta T_J}$	Gate to Source Threshold Voltage Temperature Coefficient	$I_D = 250\text{ }\mu\text{A}$, referenced to $25\text{ }^\circ\text{C}$ $I_D = 250\text{ }\mu\text{A}$, referenced to $25\text{ }^\circ\text{C}$	Q1 Q2		-5 -6		mV/ $^\circ\text{C}$
$r_{DS(on)}$	Static Drain to Source On Resistance	$V_{GS} = 10\text{ V}, I_D = 6\text{ A}$ $V_{GS} = 4.5\text{ V}, I_D = 5\text{ A}$ $V_{GS} = 10\text{ V}, I_D = 6\text{ A}, T_J = 125\text{ }^\circ\text{C}$	Q1		16 24 22	20 32 28	m Ω
		$V_{GS} = 10\text{ V}, I_D = 9\text{ A}$ $V_{GS} = 4.5\text{ V}, I_D = 7\text{ A}$ $V_{GS} = 10\text{ V}, I_D = 9\text{ A}, T_J = 125\text{ }^\circ\text{C}$	Q2		7.3 9.5 10	9.5 13.5 13	
g_{FS}	Forward Transconductance	$V_{DD} = 5\text{ V}, I_D = 6\text{ A}$ $V_{DD} = 5\text{ V}, I_D = 9\text{ A}$	Q1 Q2		29 56		S

Dynamic Characteristics

C_{iss}	Input Capacitance		Q1 Q2		495 1180	660 1570	pF
C_{oss}	Output Capacitance	$V_{DS} = 15\text{ V}, V_{GS} = 0\text{ V}, f = 1\text{ MHz}$	Q1 Q2		145 330	195 440	pF
C_{riss}	Reverse Transfer Capacitance		Q1 Q2		20 30	30 45	pF
R_g	Gate Resistance		Q1 Q2		1.4 1.4		Ω

Switching Characteristics

$t_{d(on)}$	Turn-On Delay Time	Q1	Q1 Q2		11 13	20 23	ns
t_r	Rise Time	$V_{DD} = 15\text{ V}, I_D = 1\text{ A},$ $V_{GS} = 10\text{ V}, R_{GEN} = 6\text{ }\Omega$	Q1 Q2		3.1 4	10 10	ns
$t_{d(off)}$	Turn-Off Delay Time	Q2	Q1 Q2		35 38	56 60	ns
t_f	Fall Time	$V_{DD} = 15\text{ V}, I_D = 1\text{ A},$ $V_{GS} = 10\text{ V}, R_{GEN} = 6\text{ }\Omega$	Q1 Q2		1.3 6	10 12	ns
$Q_{g(TOT)}$	Total Gate Charge	$V_{GS} = 0\text{ V to }10\text{ V}$	Q1 Q2		7.3 16	10 22	nC
$Q_{g(TOT)}$	Total Gate Charge	$V_{GS} = 0\text{ V to }4.5\text{ V}$	Q1 Q2		3.1 7	4.3 10	nC
Q_{gs}	Gate to Source Charge	Q2: $V_{DD} = 15\text{ V},$ $I_D = 9\text{ A},$	Q1 Q2		1.8 4.1		nC
Q_{gd}	Gate to Drain "Miller" Charge		Q1 Q2		1 1.5		nC

Electrical Characteristics $T_J = 25\text{ }^\circ\text{C}$ unless otherwise noted

Symbol	Parameter	Test Conditions	Type	Min	Typ	Max	Units
Drain-Source Diode Characteristics							
V_{SD}	Source to Drain Diode Forward Voltage	$V_{GS} = 0\text{ V}, I_S = 6\text{ A}$ (Note 2)	Q1		0.8	1.2	V
		$V_{GS} = 0\text{ V}, I_S = 9\text{ A}$ (Note 2)	Q2		0.8	1.2	
t_{rr}	Reverse Recovery Time	Q1 $I_F = 6\text{ A}, di/dt = 100\text{ A/s}$	Q1		13	24	ns
			Q2		21	34	
Q_{rr}	Reverse Recovery Charge	Q2 $I_F = 9\text{ A}, di/dt = 100\text{ A/s}$	Q1		2.3	10	nC
			Q2		5.6	12	

Notes:

1. $R_{\theta JA}$ is determined with the device mounted on a 1in² pad 2 oz copper pad on a 1.5 x 1.5 in. board of FR-4 material. $R_{\theta JC}$ is guaranteed by design while $R_{\theta CA}$ is determined by the user's board design.

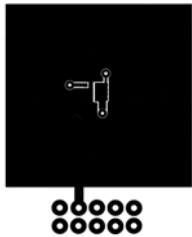

a. 65 °C/W when mounted on a 1 in² pad of 2 oz copper



b. 55 °C/W when mounted on a 1 in² pad of 2 oz copper

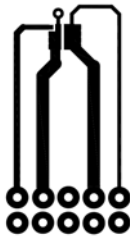

c. 180 °C/W when mounted on a minimum pad of 2 oz copper

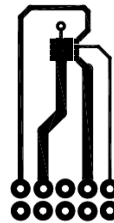

d. 145 °C/W when mounted on a minimum pad of 2 oz copper

2. Pulse Test: Pulse Width < 300 μs, Duty cycle < 2.0%.

3. As an N-ch device, the negative Vgs rating is for low duty cycle pulse occurrence only. No continuous rating is implied.

Typical Characteristics (Q1 N-Channel) $T_J = 25^\circ\text{C}$ unless otherwise noted

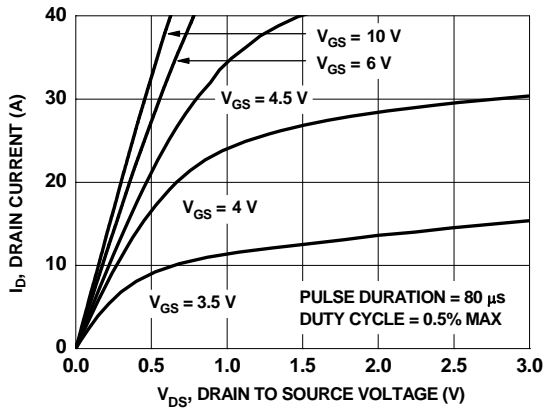

Figure 1. On Region Characteristics

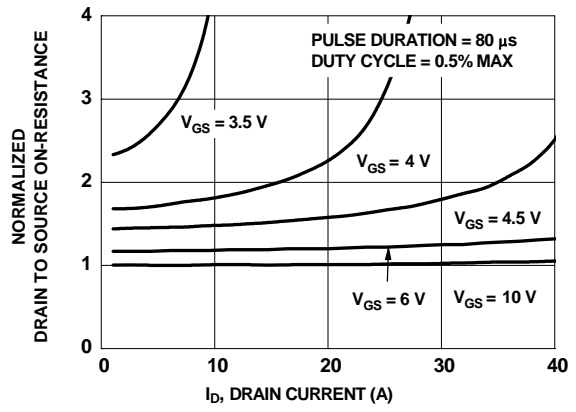

Figure 2. Normalized On-Resistance vs Drain Current and Gate Voltage

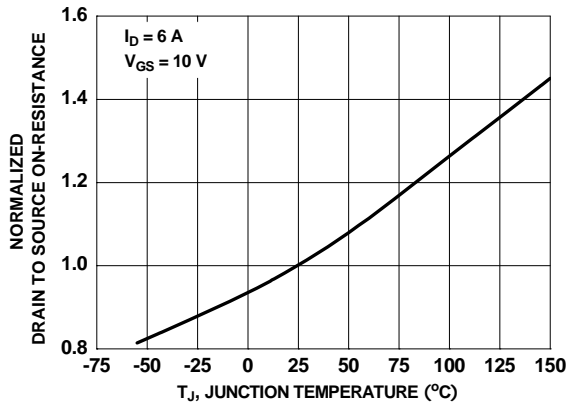

Figure 3. Normalized On Resistance vs Junction Temperature

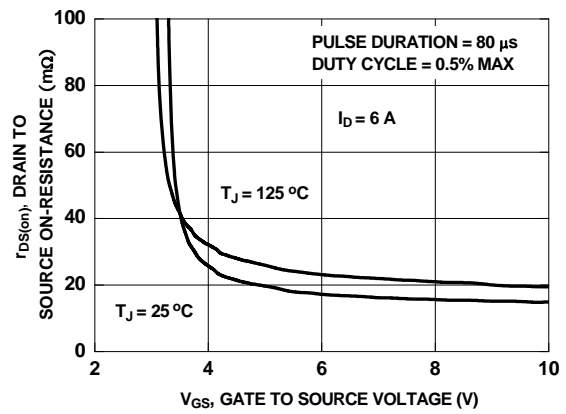

Figure 4. On-Resistance vs Gate to Source Voltage

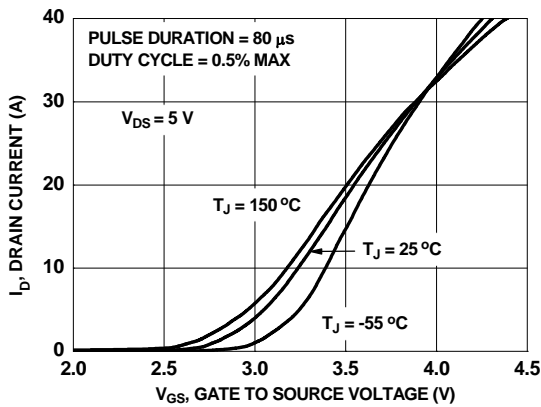

Figure 5. Transfer Characteristics

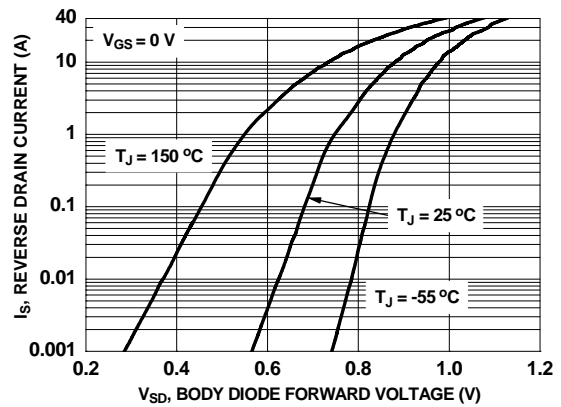

Figure 6. Source to Drain Diode Forward Voltage vs Source Current

Typical Characteristics (Q1 N-Channel) $T_J = 25^\circ\text{C}$ unless otherwise noted

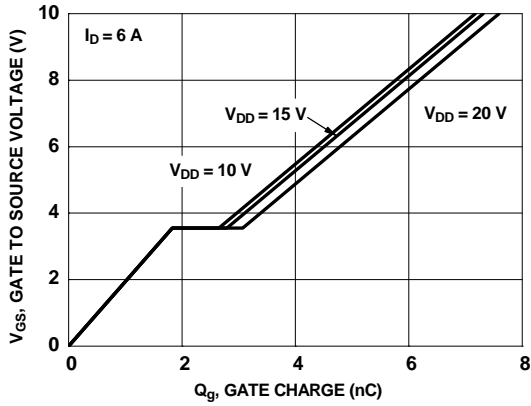

Figure 7. Gate Charge Characteristics

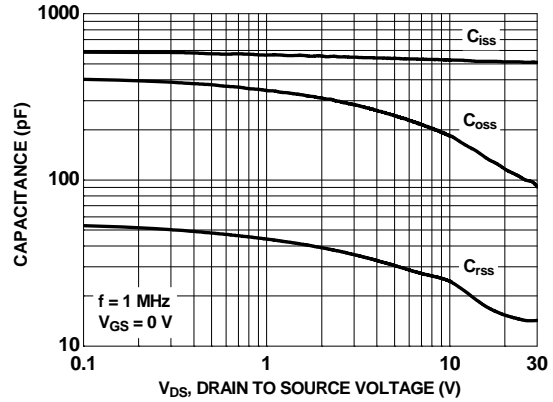

Figure 8. Capacitance vs Drain to Source Voltage

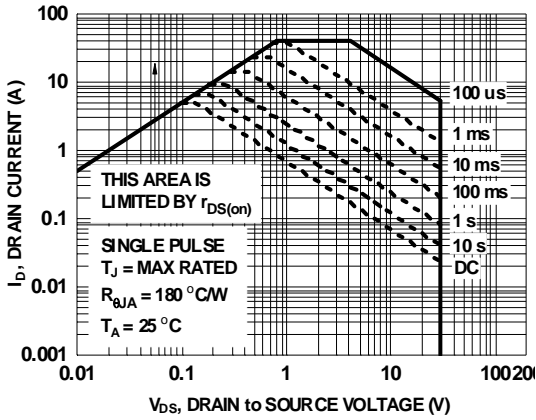

Figure 9. Forward Bias Safe Operating Area

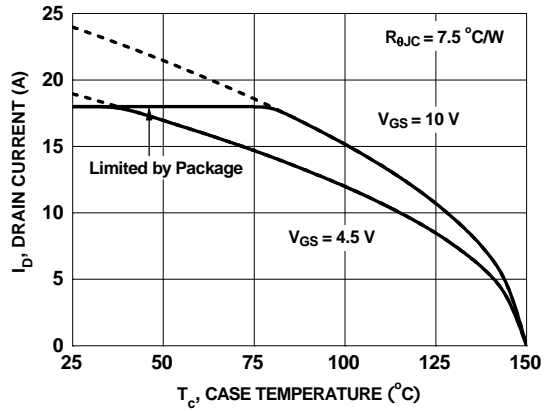

Figure 10. Maximum Continuous Drain Current vs Case Temperature

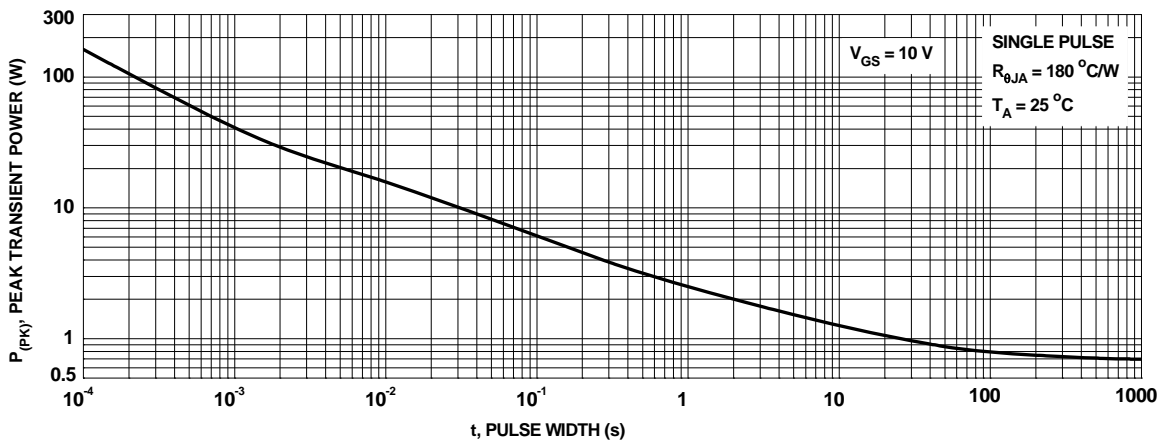

Figure 11. Single Pulse Maximum Power Dissipation

Typical Characteristics (Q1 N-Channel) $T_J = 25\text{ }^\circ\text{C}$ unless otherwise noted

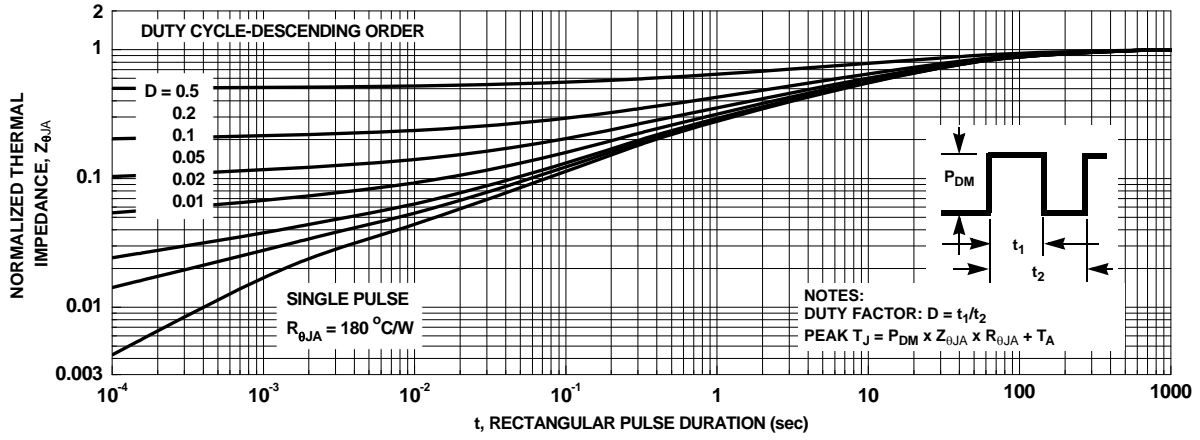

Figure 12. Junction-to-Ambient Transient Thermal Response Curve

Typical Characteristics (Q2 N-Channel) $T_J = 25\text{ }^\circ\text{C}$ unless otherwise noted

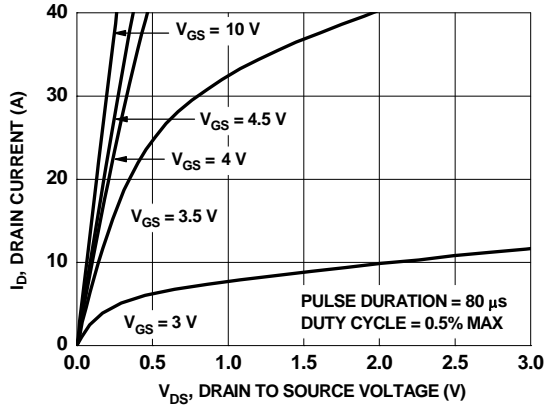

Figure 13. On-Region Characteristics

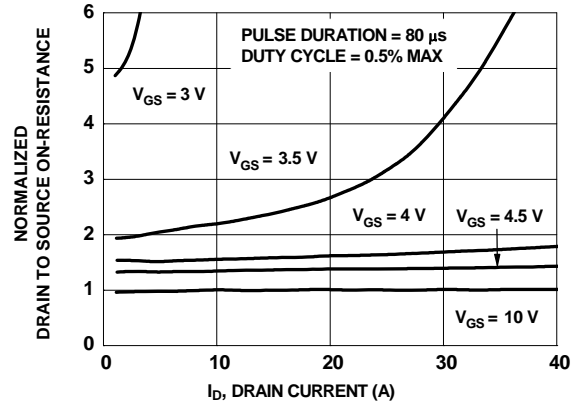

Figure 14. Normalized on-Resistance vs Drain Current and Gate Voltage

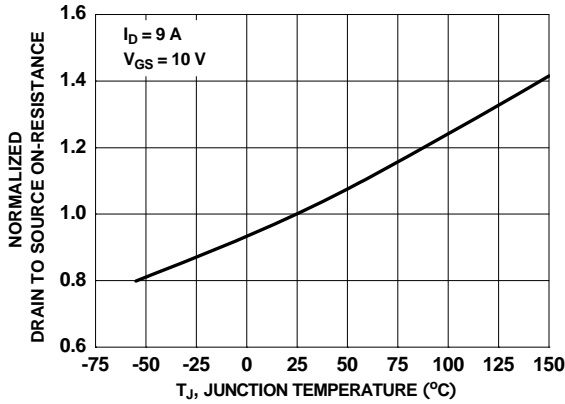

Figure 15. Normalized On-Resistance vs Junction Temperature

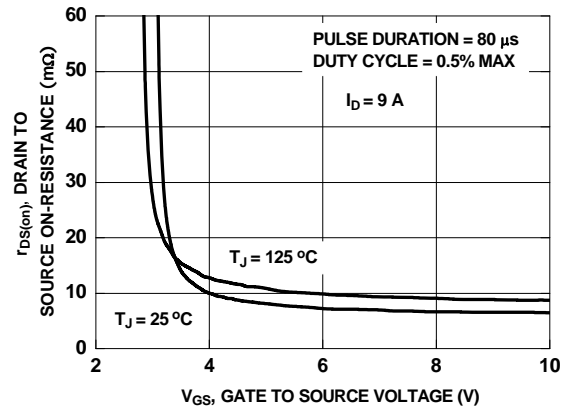

Figure 16. On-Resistance vs Gate to Source Voltage

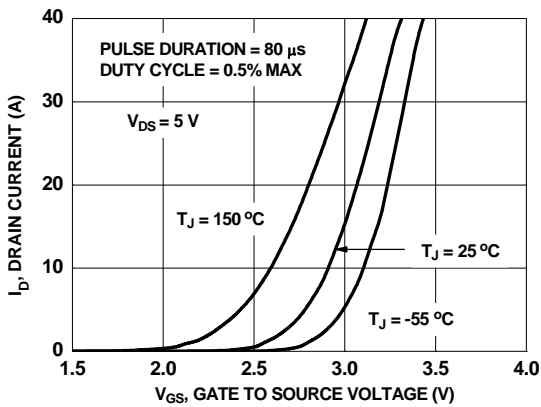

Figure 17. Transfer Characteristics

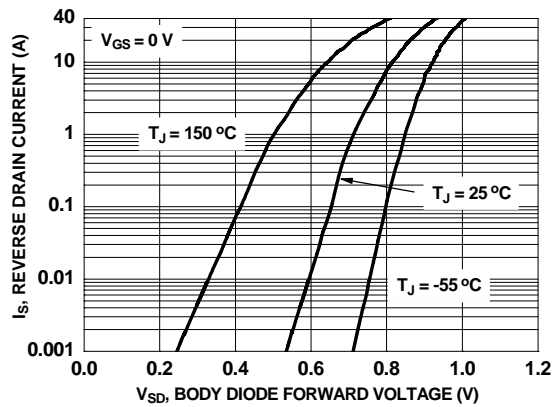

Figure 18. Source to Drain Diode Forward Voltage vs Source Current

Typical Characteristics (Q2 N-Channel) $T_J = 25\text{ }^\circ\text{C}$ unless otherwise noted

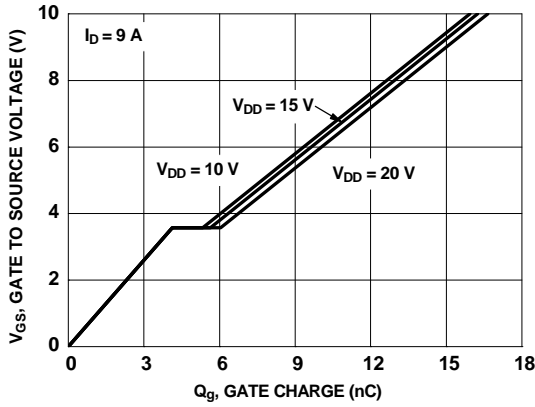

Figure 19. Gate Charge Characteristics

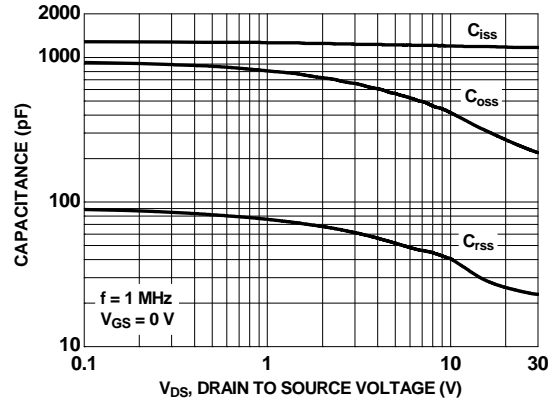

Figure 20. Capacitance vs Drain to Source Voltage

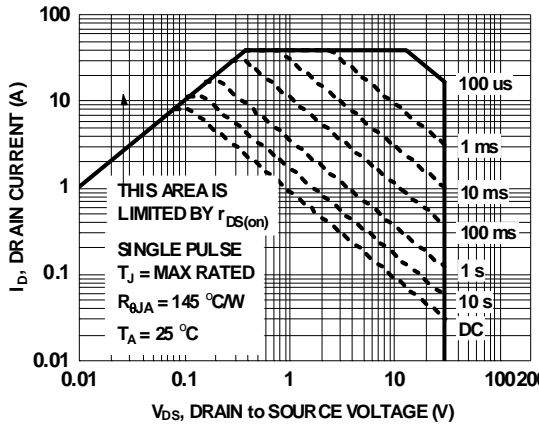

Figure 21. Forward Bias Safe Operating Area

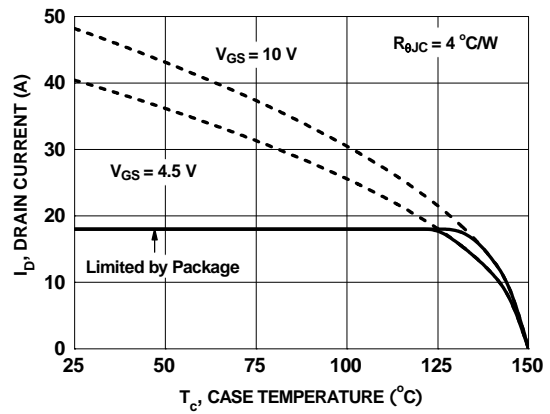

Figure 22. Maximum Continuous Drain Current vs Case Temperature

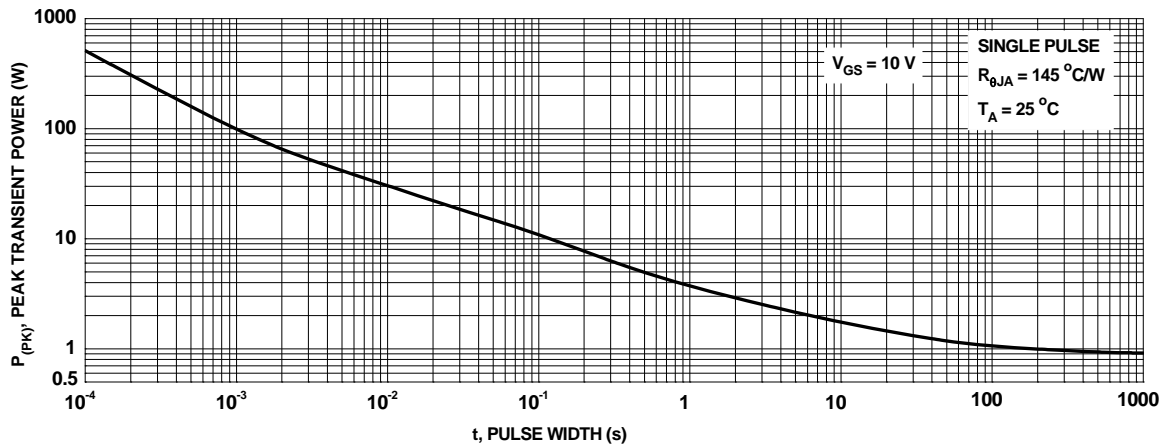

Figure 22. Single Pulse Maximum Power Dissipation

Typical Characteristics (Q2 N-Channel) $T_J = 25\text{ }^\circ\text{C}$ unless otherwise noted

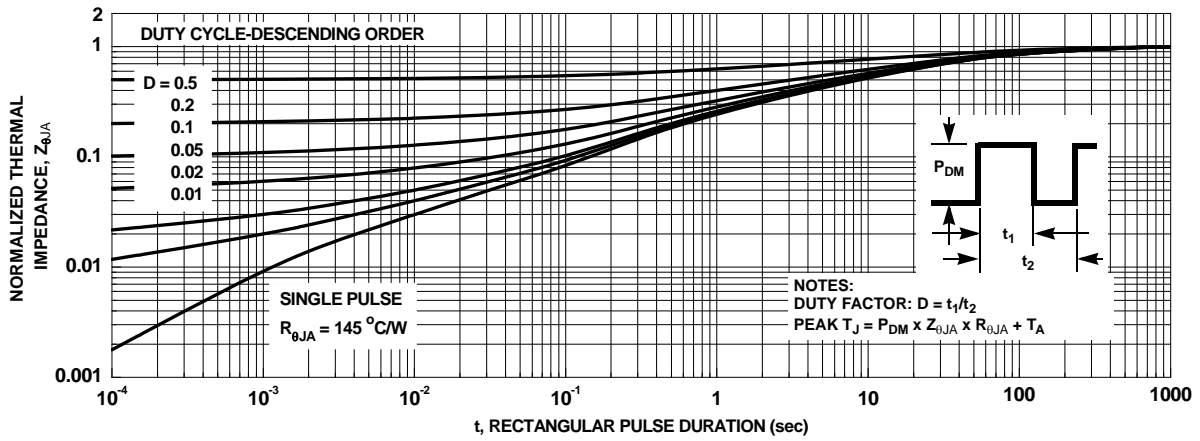
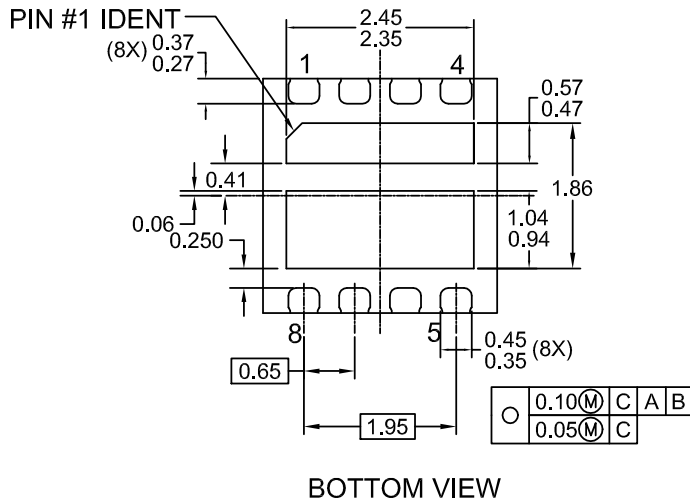
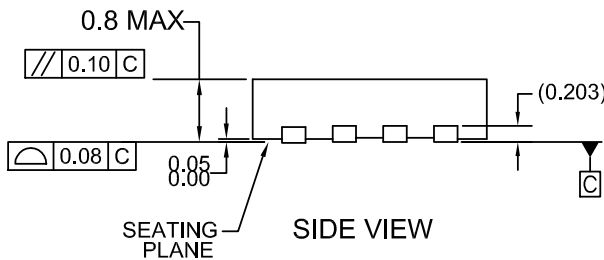
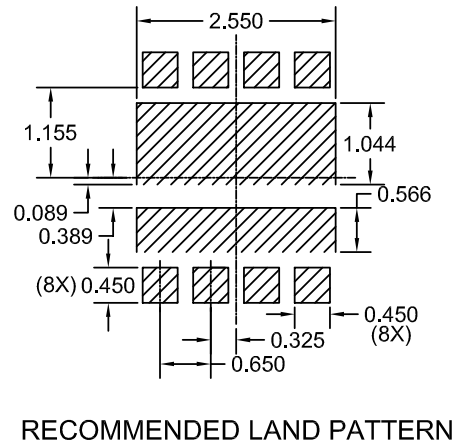
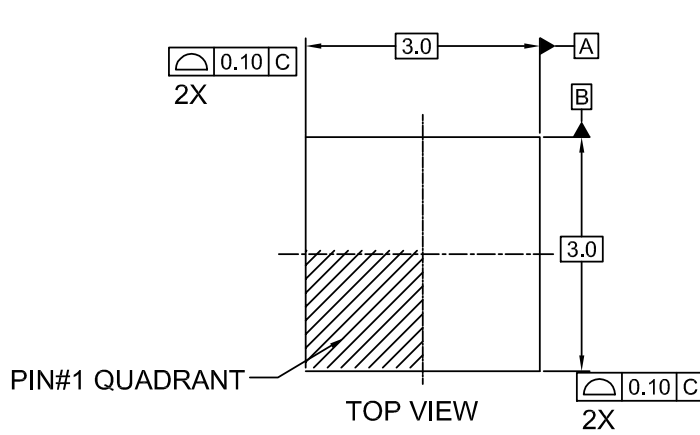

Figure 23. Junction-to-Ambient Transient Thermal Response Curve

Dimensional Outline and Pad Layout



NOTES:

- A. DOES NOT CONFORM TO JEDEC REGISTRATION MO-229
- B. DIMENSIONS ARE IN MILLIMETERS.
- C. DIMENSIONS AND TOLERANCES PER ASME Y14.5M, 1994
- C. DRAWING FILE NAME : MLP08NREVA

Package drawings are provided as a service to customers considering Fairchild components. Drawings may change in any manner without notice. Please note the revision and/or date on the drawing and contact a Fairchild Semiconductor representative to verify or obtain the most recent revision. Package specifications do not expand the terms of Fairchild's worldwide terms and conditions, specifically the warranty therein, which covers Fairchild products.

Always visit Fairchild Semiconductor's online packaging area for the most recent package drawings:
http://www.fairchildsemi.com/package/packageDetails.html?id=PN_MLDED-CX8



TRADEMARKS

The following includes registered and unregistered trademarks and service marks, owned by Fairchild Semiconductor and/or its global subsidiaries, and is not intended to be an exhaustive list of all such trademarks.

- | | | | |
|--------------------------|---|---------------------------------------|------------------|
| AccuPower™ | F-PFS™ | PowerTrench® | SYSTEM GENERAL® |
| AX-CAP®* | FRFET® | PowerXS™ | TinyBoost® |
| BitSiC™ | Global Power ResourceSM | Programmable Active Droop™ | TinyBuck® |
| Build it Now™ | GreenBridge™ | QFET® | TinyCalc™ |
| CorePLUS™ | Green FPS™ | QS™ | TinyLogic® |
| CorePOWER™ | Green FPS™ e-Series™ | Quiet Series™ | TINYOPTO™ |
| CROSSVOLT™ | Gmax™ | RapidConfigure™ | TinyPower™ |
| CTL™ | GTO™ | Saving our world, 1mW/W/kW at a time™ | TinyPWM™ |
| Current Transfer Logic™ | IntelliMAX™ | SignalWise™ | TranSIC™ |
| DEUXPEED® | ISOPLANAR™ | SmartMax™ | TriFault Detect™ |
| Dual Cool™ | Marking Small Speakers Sound Louder and Better™ | SMART START™ | TRUECURRENT®* |
| EcoSPARK® | MegaBuck™ | Solutions for Your Success™ | µSerDes™ |
| EfficientMax™ | MICROCOUPLER™ | SPM® | UHC® |
| ESBC™ | MicroFET™ | STEALTH™ | Ultra FRFET™ |
| Fairchild® | MicroPak™ | SuperFET® | UniFET™ |
| Fairchild Semiconductor® | MicroPak2™ | SuperSOT™-3 | VCX™ |
| FACT Quiet Series™ | MillerDrive™ | SuperSOT™-6 | VisualMax™ |
| FACT® | MotionMax™ | SuperSOT™-8 | VoltagePlus™ |
| FAST® | mWSaver® | SupreMOS® | XST™ |
| FastvCore™ | OptoHiT™ | SyncFET™ | 仙童™ |
| FETBench™ | OPTOLOGIC® | Sync-Lock™ | |
| FPS™ | OPTOPLANAR® | | |

*Trademarks of System General Corporation, used under license by Fairchild Semiconductor.

DISCLAIMER

FAIRCHILD SEMICONDUCTOR RESERVES THE RIGHT TO MAKE CHANGES WITHOUT FURTHER NOTICE TO ANY PRODUCTS HEREIN TO IMPROVE RELIABILITY, FUNCTION, OR DESIGN. FAIRCHILD DOES NOT ASSUME ANY LIABILITY ARISING OUT OF THE APPLICATION OR USE OF ANY PRODUCT OR CIRCUIT DESCRIBED HEREIN; NEITHER DOES IT CONVEY ANY LICENSE UNDER ITS PATENT RIGHTS, NOR THE RIGHTS OF OTHERS. THESE SPECIFICATIONS DO NOT EXPAND THE TERMS OF FAIRCHILD'S WORLDWIDE TERMS AND CONDITIONS, SPECIFICALLY THE WARRANTY THEREIN, WHICH COVERS THESE PRODUCTS.

LIFE SUPPORT POLICY

FAIRCHILD'S PRODUCTS ARE NOT AUTHORIZED FOR USE AS CRITICAL COMPONENTS IN LIFE SUPPORT DEVICES OR SYSTEMS WITHOUT THE EXPRESS WRITTEN APPROVAL OF FAIRCHILD SEMICONDUCTOR CORPORATION.

As used here in:

- Life support devices or systems are devices or systems which, (a) are intended for surgical implant into the body or (b) support or sustain life, and (c) whose failure to perform when properly used in accordance with instructions for use provided in the labeling, can be reasonably expected to result in a significant injury of the user.
- A critical component in any component of a life support, device, or system whose failure to perform can be reasonably expected to cause the failure of the life support device or system, or to affect its safety or effectiveness.

ANTI-COUNTERFEITING POLICY

Fairchild Semiconductor Corporation's Anti-Counterfeiting Policy. Fairchild's Anti-Counterfeiting Policy is also stated on our external website, www.Fairchildsemi.com, under Sales Support.

Counterfeiting of semiconductor parts is a growing problem in the industry. All manufactures of semiconductor products are experiencing counterfeiting of their parts. Customers who inadvertently purchase counterfeit parts experience many problems such as loss of brand reputation, substandard performance, failed application, and increased cost of production and manufacturing delays. Fairchild is taking strong measures to protect ourselves and our customers from the proliferation of counterfeit parts. Fairchild strongly encourages customers to purchase Fairchild parts either directly from Fairchild or from Authorized Fairchild Distributors who are listed by country on our web page cited above. Products customers buy either from Fairchild directly or from Authorized Fairchild Distributors are genuine parts, have full traceability, meet Fairchild's quality standards for handling and storage and provide access to Fairchild's full range of up-to-date technical and product information. Fairchild and our Authorized Distributors will stand behind all warranties and will appropriately address and warranty issues that may arise. Fairchild will not provide any warranty coverage or other assistance for parts bought from Unauthorized Sources. Fairchild is committed to combat this global problem and encourage our customers to do their part in stopping this practice by buying direct or from authorized distributors.

PRODUCT STATUS DEFINITIONS

Definition of Terms

Datasheet Identification	Product Status	Definition
Advance Information	Formative / In Design	Datasheet contains the design specifications for product development. Specifications may change in any manner without notice.
Preliminary	First Production	Datasheet contains preliminary data; supplementary data will be published at a later date. Fairchild Semiconductor reserves the right to make changes at any time without notice to improve design.
No Identification Needed	Full Production	Datasheet contains final specifications. Fairchild Semiconductor reserves the right to make changes at any time without notice to improve the design.
Obsolete	Not In Production	Datasheet contains specifications on a product that is discontinued by Fairchild Semiconductor. The datasheet is for reference information only.

ON Semiconductor and  are trademarks of Semiconductor Components Industries, LLC dba ON Semiconductor or its subsidiaries in the United States and/or other countries. ON Semiconductor owns the rights to a number of patents, trademarks, copyrights, trade secrets, and other intellectual property. A listing of ON Semiconductor's product/patent coverage may be accessed at www.onsemi.com/site/pdf/Patent-Marking.pdf. ON Semiconductor reserves the right to make changes without further notice to any products herein. ON Semiconductor makes no warranty, representation or guarantee regarding the suitability of its products for any particular purpose, nor does ON Semiconductor assume any liability arising out of the application or use of any product or circuit, and specifically disclaims any and all liability, including without limitation special, consequential or incidental damages. Buyer is responsible for its products and applications using ON Semiconductor products, including compliance with all laws, regulations and safety requirements or standards, regardless of any support or applications information provided by ON Semiconductor. "Typical" parameters which may be provided in ON Semiconductor data sheets and/or specifications can and do vary in different applications and actual performance may vary over time. All operating parameters, including "Typicals" must be validated for each customer application by customer's technical experts. ON Semiconductor does not convey any license under its patent rights nor the rights of others. ON Semiconductor products are not designed, intended, or authorized for use as a critical component in life support systems or any FDA Class 3 medical devices or medical devices with a same or similar classification in a foreign jurisdiction or any devices intended for implantation in the human body. Should Buyer purchase or use ON Semiconductor products for any such unintended or unauthorized application, Buyer shall indemnify and hold ON Semiconductor and its officers, employees, subsidiaries, affiliates, and distributors harmless against all claims, costs, damages, and expenses, and reasonable attorney fees arising out of, directly or indirectly, any claim of personal injury or death associated with such unintended or unauthorized use, even if such claim alleges that ON Semiconductor was negligent regarding the design or manufacture of the part. ON Semiconductor is an Equal Opportunity/Affirmative Action Employer. This literature is subject to all applicable copyright laws and is not for resale in any manner.

PUBLICATION ORDERING INFORMATION

LITERATURE FULFILLMENT:

Literature Distribution Center for ON Semiconductor
19521 E. 32nd Pkwy, Aurora, Colorado 80011 USA
Phone: 303-675-2175 or 800-344-3860 Toll Free USA/Canada
Fax: 303-675-2176 or 800-344-3867 Toll Free USA/Canada
Email: orderlit@onsemi.com

N. American Technical Support: 800-282-9855 Toll Free
USA/Canada
Europe, Middle East and Africa Technical Support:
Phone: 421 33 790 2910
Japan Customer Focus Center
Phone: 81-3-5817-1050

ON Semiconductor Website: www.onsemi.com
Order Literature: <http://www.onsemi.com/orderlit>
For additional information, please contact your local
Sales Representative