



Is Now Part of



**ON Semiconductor®**

To learn more about ON Semiconductor, please visit our website at  
[www.onsemi.com](http://www.onsemi.com)

Please note: As part of the Fairchild Semiconductor integration, some of the Fairchild orderable part numbers will need to change in order to meet ON Semiconductor's system requirements. Since the ON Semiconductor product management systems do not have the ability to manage part nomenclature that utilizes an underscore (\_), the underscore (\_) in the Fairchild part numbers will be changed to a dash (-). This document may contain device numbers with an underscore (\_). Please check the ON Semiconductor website to verify the updated device numbers. The most current and up-to-date ordering information can be found at [www.onsemi.com](http://www.onsemi.com). Please email any questions regarding the system integration to [Fairchild\\_questions@onsemi.com](mailto:Fairchild_questions@onsemi.com).

ON Semiconductor and the ON Semiconductor logo are trademarks of Semiconductor Components Industries, LLC dba ON Semiconductor or its subsidiaries in the United States and/or other countries. ON Semiconductor owns the rights to a number of patents, trademarks, copyrights, trade secrets, and other intellectual property. A listing of ON Semiconductor's product/patent coverage may be accessed at [www.onsemi.com/site/pdf/Patent-Marking.pdf](http://www.onsemi.com/site/pdf/Patent-Marking.pdf). ON Semiconductor reserves the right to make changes without further notice to any products herein. ON Semiconductor makes no warranty, representation or guarantee regarding the suitability of its products for any particular purpose, nor does ON Semiconductor assume any liability arising out of the application or use of any product or circuit, and specifically disclaims any and all liability, including without limitation special, consequential or incidental damages. Buyer is responsible for its products and applications using ON Semiconductor products, including compliance with all laws, regulations and safety requirements or standards, regardless of any support or applications information provided by ON Semiconductor. "Typical" parameters which may be provided in ON Semiconductor data sheets and/or specifications can and do vary in different applications and actual performance may vary over time. All operating parameters, including "Typicals" must be validated for each customer application by customer's technical experts. ON Semiconductor does not convey any license under its patent rights nor the rights of others. ON Semiconductor products are not designed, intended, or authorized for use as a critical component in life support systems or any FDA Class 3 medical devices or medical devices with a same or similar classification in a foreign jurisdiction or any devices intended for implantation in the human body. Should Buyer purchase or use ON Semiconductor products for any such unintended or unauthorized application, Buyer shall indemnify and hold ON Semiconductor and its officers, employees, subsidiaries, affiliates, and distributors harmless against all claims, costs, damages, and expenses, and reasonable attorney fees arising out of, directly or indirectly, any claim of personal injury or death associated with such unintended or unauthorized use, even if such claim alleges that ON Semiconductor was negligent regarding the design or manufacture of the part. ON Semiconductor is an Equal Opportunity/Affirmative Action Employer. This literature is subject to all applicable copyright laws and is not for resale in any manner.

# FDZ8040L

## Integrated Load Switch

### Features

- Optimized for Low-Voltage Core ICs in Portable Systems
- Very Small Package Dimension: WLCSP 0.8 X 0.8 X 0.5 mm<sup>3</sup>
- Current = 1.2 A, V<sub>IN</sub> Max. = 4 V
- Current = 2 A, V<sub>IN</sub> Max. = 4 V (Pulsed)
- R<sub>DS(on)</sub> = 80 mΩ at V<sub>ON</sub> = V<sub>IN</sub> = 4 V
- R<sub>DS(on)</sub> = 85 mΩ at V<sub>ON</sub> = V<sub>IN</sub> = 3.6 V
- R<sub>DS(on)</sub> = 90 mΩ at V<sub>ON</sub> = V<sub>IN</sub> = 3 V
- R<sub>DS(on)</sub> = 360 mΩ at V<sub>ON</sub> = V<sub>IN</sub> = 0.9 V
- R<sub>DS(on)</sub> = 1000 mΩ at V<sub>ON</sub> = V<sub>IN</sub> = 0.8 V
- RoHS Compliant

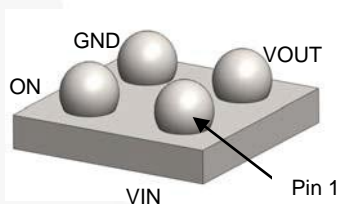

Figure 1. Bottom View

### Description

This device is particularly suited for compact power management in portable applications needing 0.8 V to 4 V input and 1.2 A output current capability. This load switch integrated a level-shifting function that drives a P-channel power MOSFET in a very small 0.8 X 0.8 X 0.5 mm<sup>3</sup> WLCSP package.

### Applications

- Load Switch
- Power Management in Portable Applications

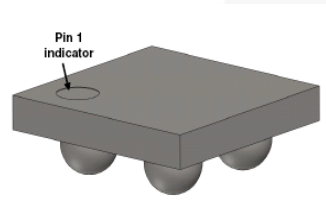

Figure 2. Top View

### Ordering Information

Part Number	Device Mark	Ball Pitch	Operating Temperature Range	Switch	Package	Packing Method
FDZ8040L	ZM	0.4 mm	-40 to 85°C	80 mΩ, P-Channel MOSFET	0.8 x 0.8 x 0.5 mm <sup>3</sup> WLCSP	Tape & Reel

### Typical Application

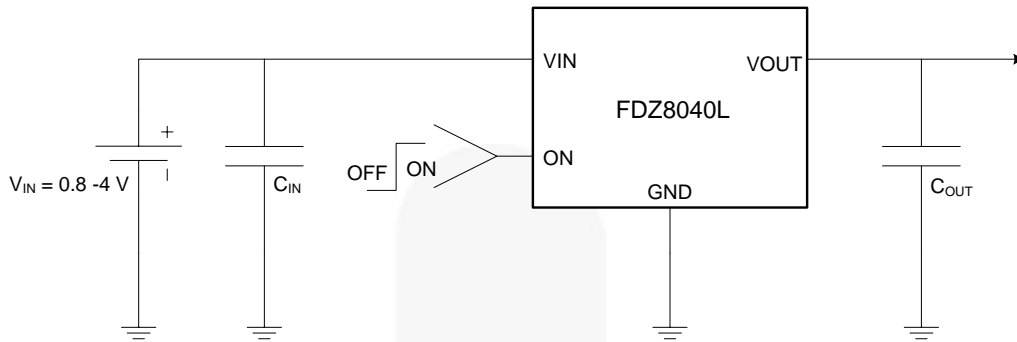

Figure 3. Typical Application

### Block Diagram

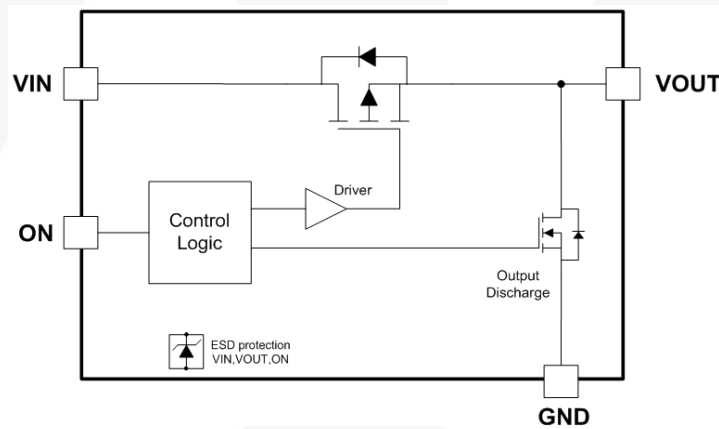

Figure 4. Internal Block Diagram

### Pin Configuration

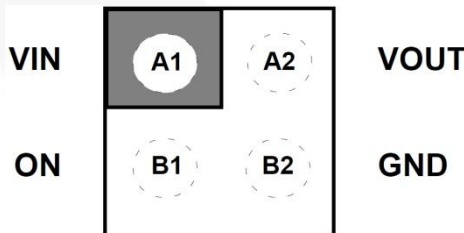

Figure 5. Top View (Bumps Down)

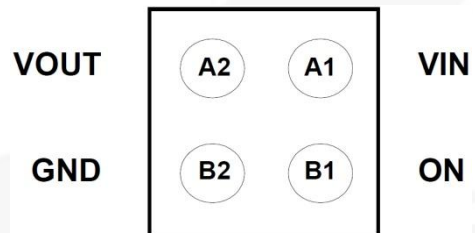

Figure 6. Bottom View (Bumps Up)

### Pin Descriptions

Pin #	Name	Description
A1	VIN	Supply Input: Input to the load switch
A2	VOUT	Switch Output: Output of the load switch
B1	ON	ON/OFF Control Input
B2	GND	Ground

## Absolute Maximum Ratings

Stresses exceeding the absolute maximum ratings may damage the device. The device may not function or be operable above the recommended operating conditions and stressing the parts to these levels is not recommended. In addition, extended exposure to stresses above the recommended operating conditions may affect device reliability. The absolute maximum ratings are stress ratings only.

Symbol	Parameter	Min.	Max.	Unit
$V_{IN}$	Voltage on VIN, VOUT, ON to GND	-0.3	4.2	V
$I_{OUT\_C}$	$I_{OUT}$ -Load Current (Continuous) <sup>(1a)</sup>		1.2	A
$I_{OUT\_P}$	$I_{OUT}$ -Load Current (Pulsed)		2	A
$P_D$	Power Dissipation at $T_A = 25^\circ\text{C}$ <sup>(1a)</sup>		0.9	W
$T_A$	Operating Temperature Range	-40	85	$^\circ\text{C}$
$T_{STG}$	Storage Temperature	-65	150	$^\circ\text{C}$
$R\theta_{JA}$	Thermal Resistance, Junction to Ambient <sup>(1a)</sup>		135	$^\circ\text{C}/\text{W}$
ESD	Electrostatic Discharge Capability	Human Body Model, JESD22-A114	8	kV
		Charged Device Model, JESD22-C101	2	

### Notes:

- $R\theta_{JA}$  is the sum of the junction-to-case and case-to-ambient thermal resistance where the case thermal reference is defined as the solder mounting surface of the drain pins.  $R\theta_{JC}$  is guaranteed by design, while  $R\theta_{JA}$  is determined by the board design.



- 135 $^\circ\text{C}/\text{W}$  when mounted on a 1-inch square pad of 2-oz copper.

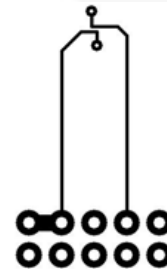

- 360 $^\circ\text{C}/\text{W}$  when mounted on a minimum pad of 2-oz copper.

- Pulse test: pulse width < 300  $\mu\text{s}$ ; duty cycle < 2.0%.

## Recommended Operating Conditions

The Recommended Operating Conditions table defines the conditions for actual device operation. Recommended operating conditions are specified to ensure optimal performance to the datasheet specifications. Fairchild does not recommend exceeding them or designing to Absolute Maximum Ratings.

Symbol	Parameter	Min.	Max.	Unit
$V_{IN}$	Voltage on VIN Pin	0.8	4.0	V
$V_{ON}$	Voltage on ON Pin	0.7	4.0	V
$T_A$	Operating Temperature Range	1 V to 4 V	-40	85
		0.8 V to 4 V	-10	

## Electrical Characteristics

$T_J = 25^\circ\text{C}$  and  $V_{IN} = 1.8\text{ V}$ , unless otherwise noted.

Symbol	Parameter	Test Conditions	Min.	Typ.	Max.	Unit
$V_{IN}$	Operation Voltage		0.8		4.0	V
$V_{IL}$	ON Input Logic Low Voltage	$1.6\text{ V} \leq V_{IN} \leq 4.0\text{ V}$			0.35	V
		$0.8\text{ V} \leq V_{IN} \leq 1.6\text{ V}$			0.25	
$V_{IH}$	ON Input Logic High Voltage	$1.6\text{ V} \leq V_{IN} \leq 4.0\text{ V}$	1.0			V
		$0.8\text{ V} \leq V_{IN} \leq 1.6\text{ V}$	0.7			
$I_Q$	Quiescent Current	$I_{OUT} = 0\text{ mA}$ , $V_{IN} = V_{ON} = 1.8\text{ V}$			2.1	$\mu\text{A}$
$I_{Q(off)}$	Off Supply Current	$I_{OUT} = 0\text{ mA}$ , $V_{IN} = 1.8\text{ V}$ , $V_{ON} = \text{GND}$			1	$\mu\text{A}$
$I_{SD(off)}$	Off Switch Current	$V_{ON} = \text{GND}$ , $V_{OUT} = 0\text{ V}$ , $V_{IN} = 1.8\text{ V}$			100	nA
$I_{ON}$	ON Input Leakage	$V_{ON} = V_{IN}$ or GND			1	$\mu\text{A}$
$R_{PD}$	Output Discharge Pull-Down Resistance			200		$\Omega$
$R_{DS(ON)}$	Static Drain-Source On-Resistance	$V_{ON} = V_{IN} = 4\text{ V}$ , $I_{OUT} = 300\text{ mA}$		50	80	m $\Omega$
		$V_{ON} = V_{IN} = 3.6\text{ V}$ , $I_{OUT} = 300\text{ mA}$		51	85	
		$V_{ON} = V_{IN} = 3\text{ V}$ , $I_{OUT} = 300\text{ mA}$		54	90	
		$V_{ON} = 0.7\text{ V}$ , $V_{IN} = 1.6\text{ V}$ , $I_{OUT} = 300\text{ mA}$		73	110	
		$V_{ON} = 0.7\text{ V}$ , $V_{IN} = 1\text{ V}$ , $I_{OUT} = 300\text{ mA}$		140	309	
		$V_{ON} = V_{IN} = 0.9\text{ V}$ , $I_{OUT} = 10\text{ mA}$		186	360	
		$V_{ON} = V_{IN} = 0.8\text{ V}$ , $I_{OUT} = 10\text{ mA}$		348	1000	
		$V_{ON} = V_{IN} = 0.9\text{ V}$ , $I_{OUT} = 10\text{ mA}$ , $T_J = 10 \sim 85^\circ\text{C}$		194	370	
		$V_{ON} = V_{IN} = 0.8\text{ V}$ , $I_{OUT} = 10\text{ mA}$ , $T_J = 10 \sim 85^\circ\text{C}$		268	750	
		$V_{IN} = 3.6\text{ V}$ , $I_{OUT} = 300\text{ mA}$ , $T_J = 85^\circ\text{C}$		59	102	

## Switching Characteristics

Symbol	Parameter	Test Conditions	Typical	Unit
$t_{d(on)}$	Turn-On Delay Time	$V_{IN} = 1.6\text{ V}, V_{ON} = 0.7\text{ V}, C_L = 1\ \mu\text{F}, R_L = 500\ \Omega$	22	$\mu\text{s}$
$t_r$	Turn-On Rise Time		23	$\mu\text{s}$
$t_{d(off)}$	Turn-Off Delay Time		109	$\mu\text{s}$
$t_f$	Turn-Off Fall Time		285	$\mu\text{s}$
$t_{d(on)}$	Turn-On Delay Time	$V_{IN} = 1\text{ V}, V_{ON} = 1.8\text{ V}, C_L = 1\ \mu\text{F}, R_L = 500\ \Omega$	37	$\mu\text{s}$
$t_r$	Turn-On Rise Time		35	$\mu\text{s}$
$t_{d(off)}$	Turn-Off Delay Time		112	$\mu\text{s}$
$t_f$	Turn-Off Fall Time		332	$\mu\text{s}$
$t_{d(on)}$	Turn-On Delay Time	$V_{IN} = 1.8\text{ V}, V_{ON} = 1.8\text{ V}, C_L = 1\ \mu\text{F}, R_L = 500\ \Omega$	20	$\mu\text{s}$
$t_r$	Turn-On Rise Time		22	$\mu\text{s}$
$t_{d(off)}$	Turn-Off Delay Time		122	$\mu\text{s}$
$t_f$	Turn-Off Fall Time		296	$\mu\text{s}$
$t_{d(on)}$	Turn-On Delay Time	$V_{IN} = 2.5\text{ V}, V_{ON} = 1.8\text{ V}, C_L = 1\ \mu\text{F}, R_L = 500\ \Omega$	15	$\mu\text{s}$
$t_r$	Turn-On Rise Time		19	$\mu\text{s}$
$t_{d(off)}$	Turn-Off Delay Time		160	$\mu\text{s}$
$t_f$	Turn-Off Fall Time		295	$\mu\text{s}$
$t_{d(on)}$	Turn-On Delay Time	$V_{IN} = 3.3\text{ V}, V_{ON} = 1.8\text{ V}, C_L = 1\ \mu\text{F}, R_L = 500\ \Omega$	13	$\mu\text{s}$
$t_r$	Turn-On Rise Time		18	$\mu\text{s}$
$t_{d(off)}$	Turn-Off Delay Time		193	$\mu\text{s}$
$t_f$	Turn-Off Fall Time		305	$\mu\text{s}$
$t_{d(on)}$	Turn-On Delay Time	$V_{IN} = 0.8\text{ V}, V_{ON} = 0.8\text{ V}, C_L = 1\ \mu\text{F}, R_L = 500\ \Omega$	53	$\mu\text{s}$
$t_r$	Turn-On Rise Time		56	$\mu\text{s}$
$t_{d(off)}$	Turn-Off Delay Time		143	$\mu\text{s}$
$t_f$	Turn-Off Fall Time		532	$\mu\text{s}$
$t_{d(on)}$	Turn-On Delay Time	$V_{IN} = 0.9\text{ V}, V_{ON} = 0.9\text{ V}, C_L = 1\ \mu\text{F}, R_L = 500\ \Omega$	51	$\mu\text{s}$
$t_r$	Turn-On Rise Time		54	$\mu\text{s}$
$t_{d(off)}$	Turn-Off Delay Time		148	$\mu\text{s}$
$t_f$	Turn-Off Fall Time		525	$\mu\text{s}$

## Typical Performance Characteristics

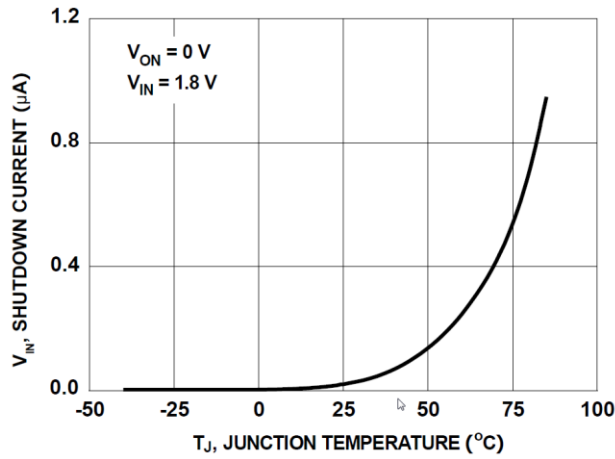

Figure 7. Shutdown Current vs. Temperature

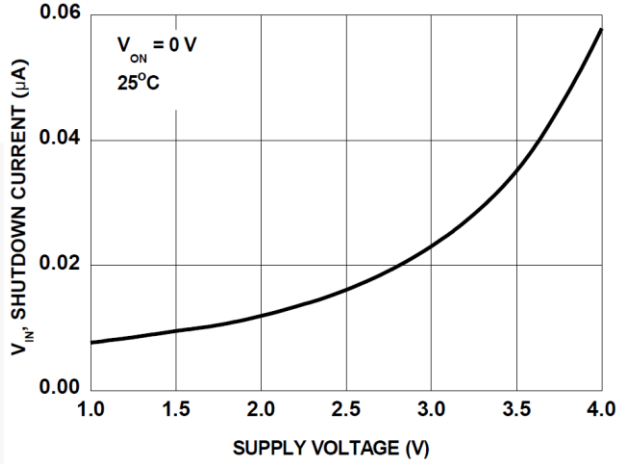

Figure 8. Shutdown Current vs. Supply Voltage

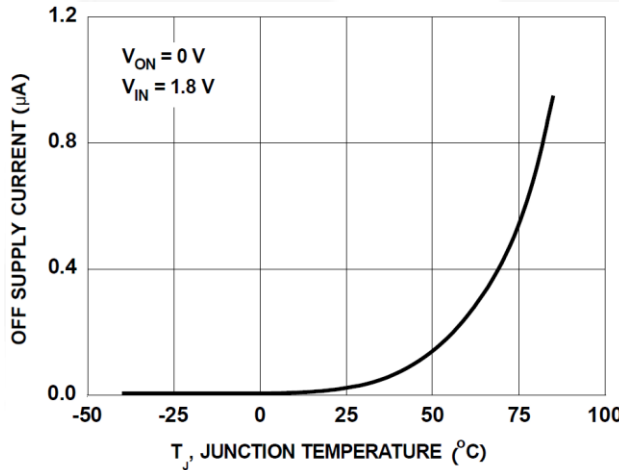

Figure 9. Off Supply Current vs. Temperature

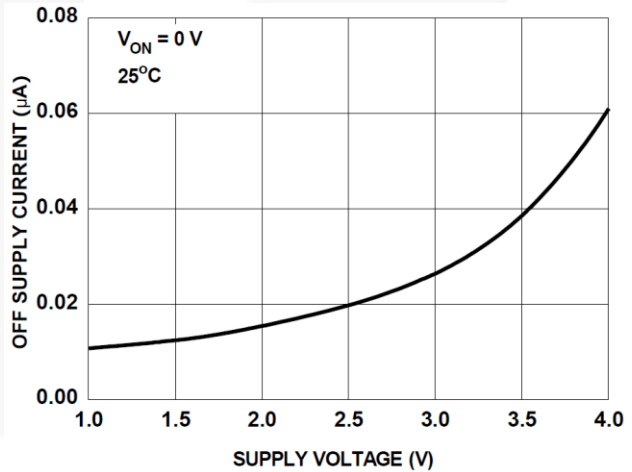

Figure 10. Off Supply Current vs. Supply Voltage

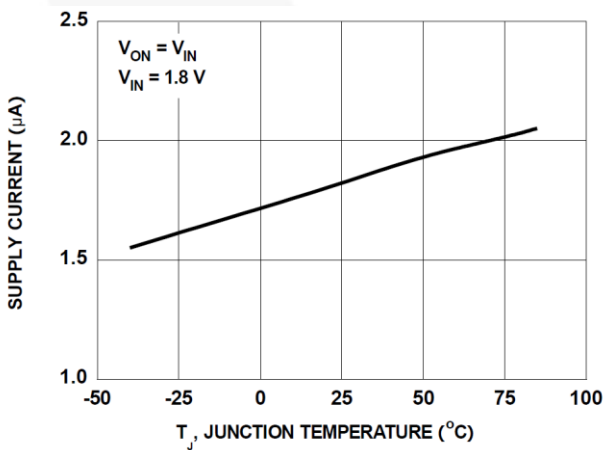

Figure 11. Quiescent Current vs. Temperature

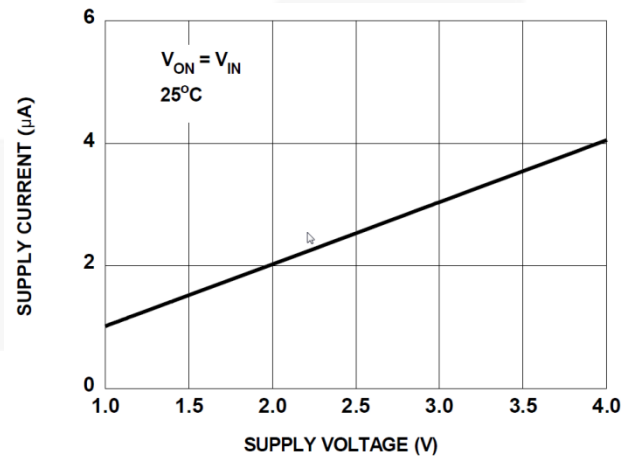

Figure 12. Quiescent Current vs. Supply Voltage

## Typical Performance Characteristics

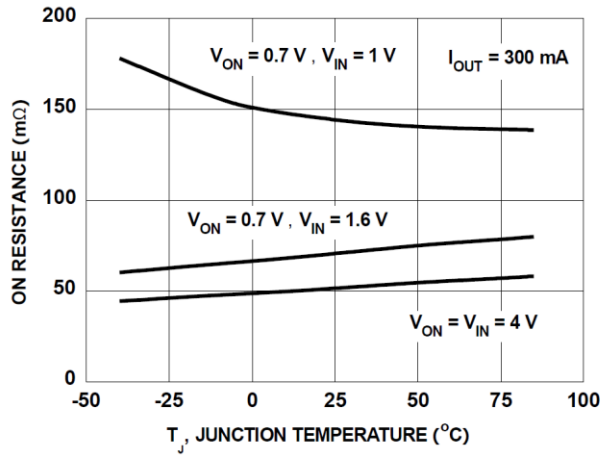

Figure 13.  $R_{ON}$  vs. Temperature

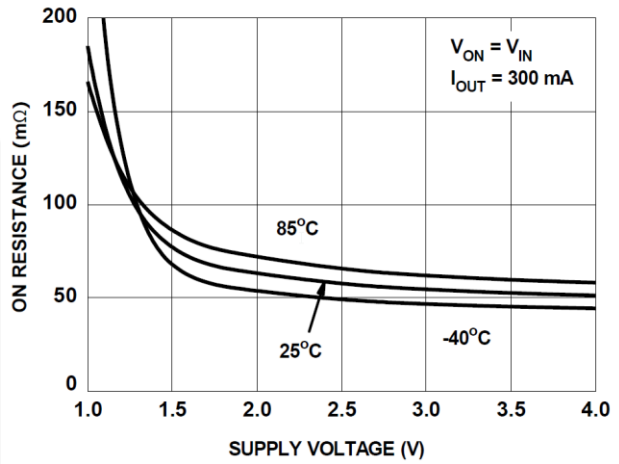

Figure 14.  $R_{ON}$  vs. Supply Voltage

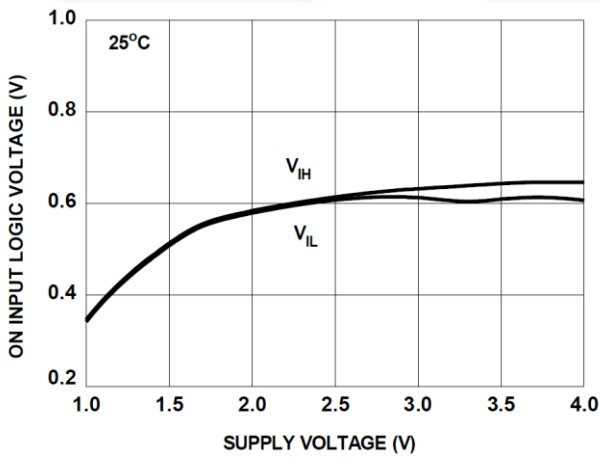

Figure 15. ON-Pin Threshold vs.  $V_{IN}$

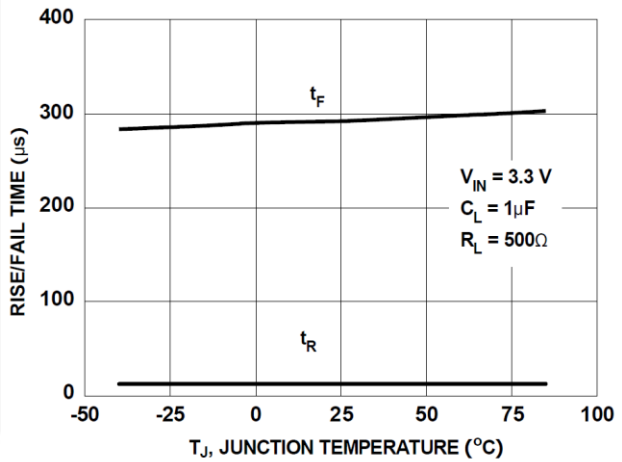

Figure 16.  $V_{OUT}$  Rise and Fall Time vs. Temperature at  $R_L=500\Omega$

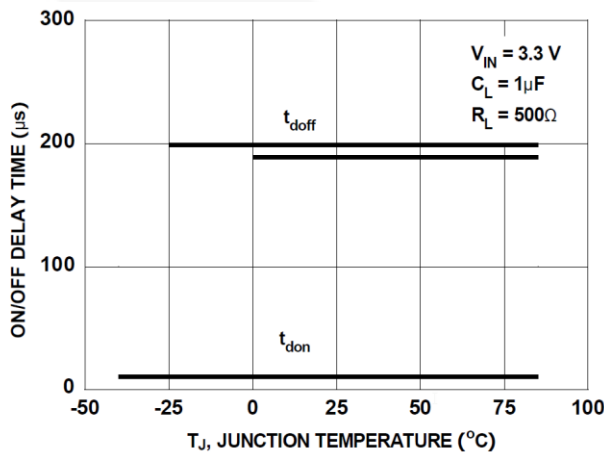

Figure 17.  $V_{OUT}$  Turn-On and Turn-Off Delay vs. Temperature at  $R_L=500\Omega$

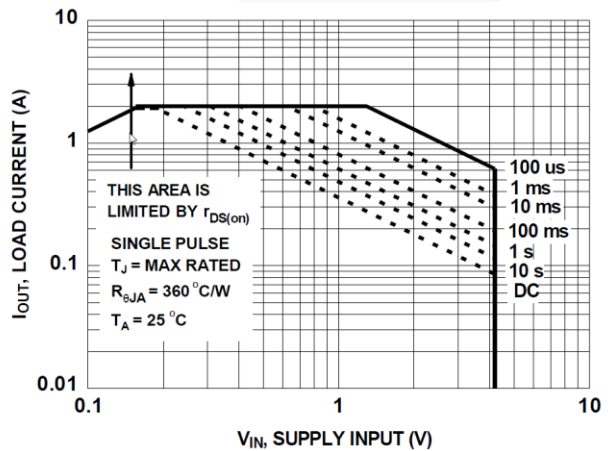

Figure 18. Forward Bias Safe Operation Area



Typical Performance Characteristics

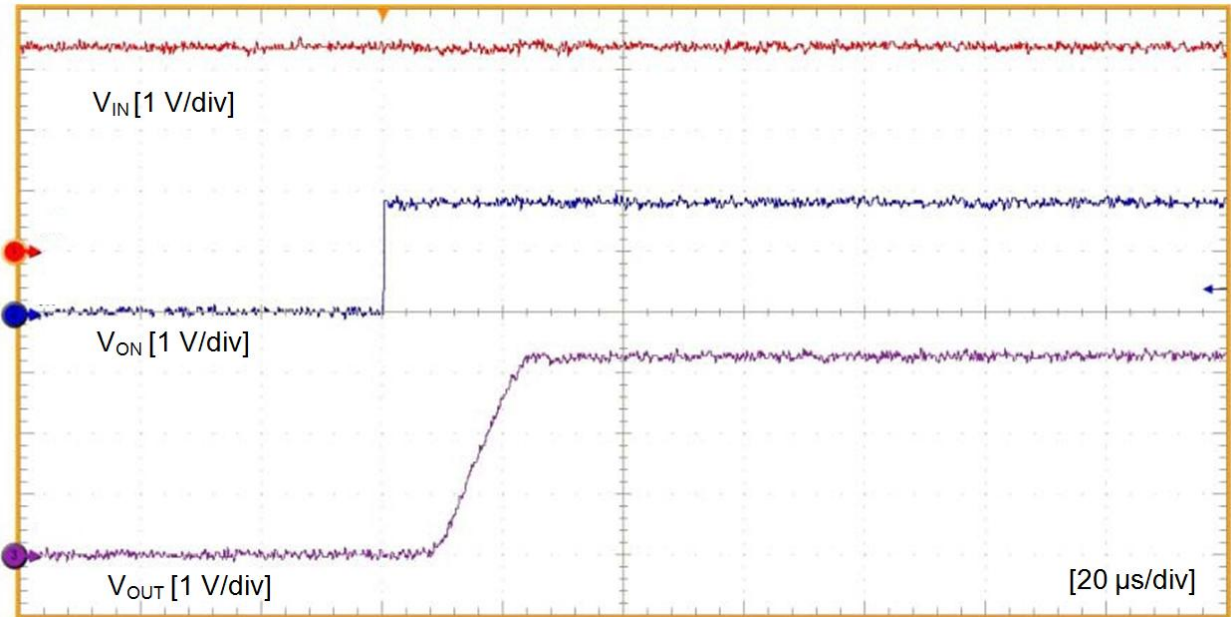

Figure 19. Turn-On Response ( $V_{IN} = 3.3 \text{ V}$ ,  $C_{OUT} = 1 \mu\text{F}$ ,  $R_L = 500 \Omega$ )

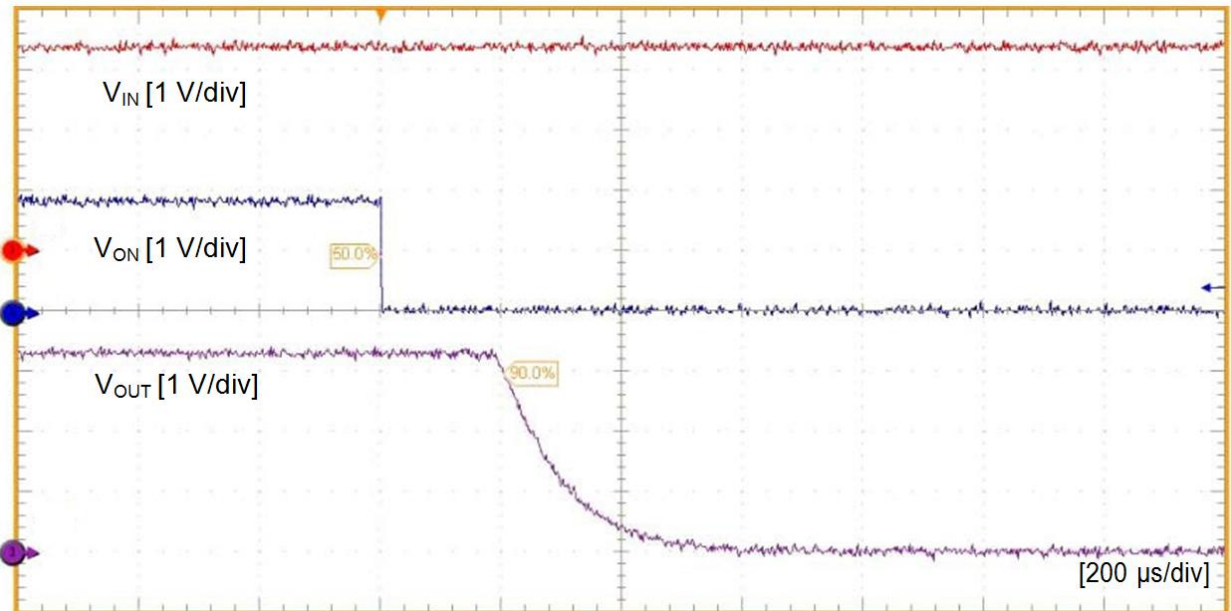

Figure 20. Turn-Off Response ( $V_{IN} = 3.3 \text{ V}$ ,  $C_{OUT} = 1 \mu\text{F}$ ,  $R_L = 500 \Omega$ )

## Functional Description

The FDZ8040L is a low- $R_{DS(ON)}$  P-channel load switch packaged in space-saving 0.8 x 0.8 WLCSP.

The core of the device is an 80 m $\Omega$  P-channel MOSFET capable of functioning over a wide input operating range

of 0.8-4 V. The ON pin, an active HIGH TTL-compatible input that supports input as low as 0.7 V, controls the state of the switch.

## Applications Information

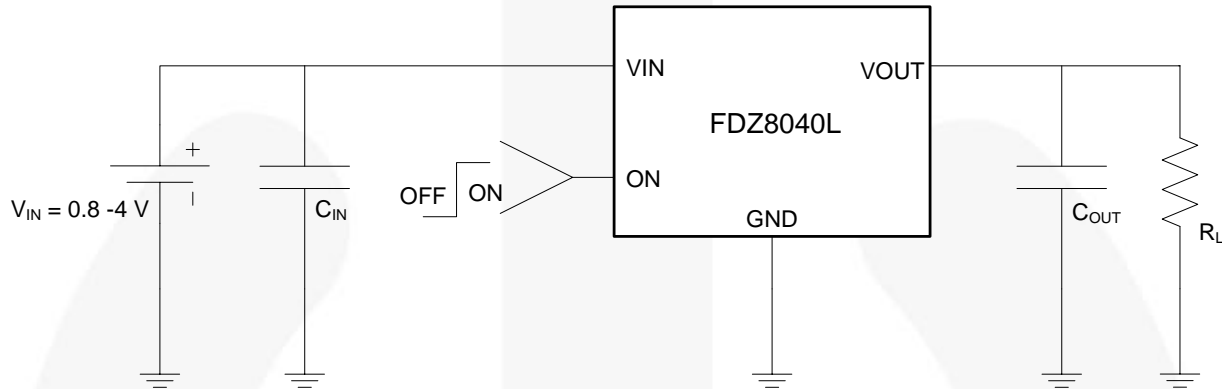

Figure 21. Typical Application

### Input Capacitor

To reduce device inrush current effect, a 0.1  $\mu\text{F}$  ceramic capacitor,  $C_{IN}$ , is recommended close to the VIN pin. A higher value of  $C_{IN}$  can be used to further reduce the voltage drop experienced as the switch is turned on into a large capacitive load.

### Output Capacitor

FDZ8040L works without an output capacitor. However, if parasitic board inductance forces  $V_{OUT}$  below GND when switching off, a 0.1  $\mu\text{F}$  capacitor,  $C_{OUT}$ , should be placed between the VOUT and GND pins.

## Physical Dimensions

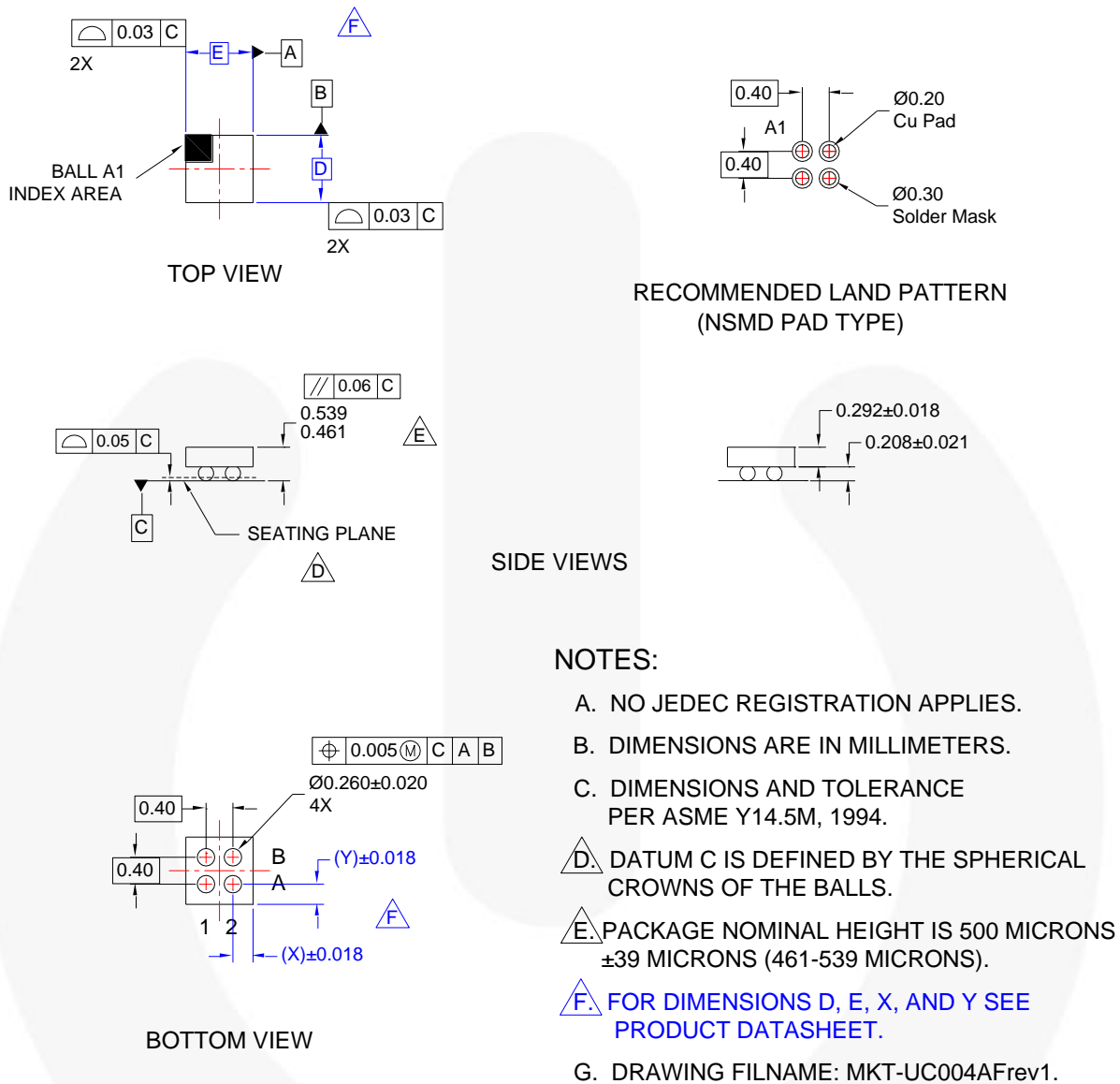

**Figure 22. 4-Ball, WLCSP, 2 X 2 Array, 0.4 mm Pitch, 250 µm Ball**

## Product-Specific Dimensions

Product	D	E	X	Y
FDZ8040L	0.8 $\pm$ 0.03 mm	0.8 $\pm$ 0.03 mm	0.21 mm	0.21 mm





Package drawings are provided as a service to customers considering Fairchild components. Drawings may change in any manner without notice. Please note the revision and/or date on the drawing and contact a Fairchild Semiconductor representative to verify or obtain the most recent revision. Package specifications do not expand the terms of Fairchild's worldwide terms and conditions, specifically the warranty therein, which covers Fairchild products.

Always visit Fairchild Semiconductor's online packaging area for the most recent package drawings:  
<http://www.fairchildsemi.com/packaging/>.



**TRADEMARKS**

The following includes registered and unregistered trademarks and service marks, owned by Fairchild Semiconductor and/or its global subsidiaries, and is not intended to be an exhaustive list of all such trademarks.

- |   |  |   |   |
|---|--|---|---|
| 2Cool™  | FPS™   |  | Sync-Lock™  |
| AccuPower™  | F-PFS™   | PowerTrench®  | SYSTEM GENERAL®   |
| AX-CAP®*  | FRFET®   | PowerXS™  | TinyBoost™  |
| BitSiC™   | Global Power Resource™                         | Programmable Active Droop™  | TinyBuck™   |
| Build it Now™   | GreenBridge™                                   | QFET®   | TinyCalc™   |
| CorePLUS™   | Green FPS™                                     | QS™   | TinyLogic®  |
| CorePOWER™  | Green FPS™ e-Series™                           | Quiet Series™   | TINYOPTO™   |
| CROSSVOLT™  | Gmax™  | RapidConfigure™   | TinyPower™  |
| CTL™  | GTO™   |  | TinyPWM™  |
| Current Transfer Logic™   | IntelliMAX™                                    | Saving our world, 1mW/W/kW at a time™   | TinyWire™   |
| DEUXPEED®   | ISOPLANAR™                                     | SignalWise™   | TranSiC™  |
| Dual Cool™  | Making Small Speakers Sound Louder and Better™ | SmartMax™   | TriFault Detect™  |
| EcoSPARK®   | MegaBuck™                                      | SMART START™  | TRUECURRENT®*   |
| EfficientMax™   | MICROCOUPLER™                                  | Solutions for Your Success™   | μSerDes™  |
| ESBC™   | MicroFET™                                      | SPM®  |  |
|  | MicroPak™                                      | STEALTH™  | UHC®  |
| Fairchild®  | MicroPak2™                                     | SuperFET®   | Ultra FRFET™  |
| Fairchild Semiconductor®  | MillerDrive™                                   | SuperSOT™-3   | UniFET™   |
| FACT Quiet Series™  | MotionMax™                                     | SuperSOT™-6   | VCX™  |
| FACT®   | mWSaver™                                       | SuperSOT™-8   | VisualMax™  |
| FAST®   | OptoHiT™                                       | SupreMOS®   | VoltagePlus™  |
| FastvCore™  | OPTOLOGIC®                                     | SyncFET™  | XS™   |
| FETBench™   | OPTOPLANAR®                                    |   |   |

\* Trademarks of System General Corporation, used under license by Fairchild Semiconductor.

**DISCLAIMER**

FAIRCHILD SEMICONDUCTOR RESERVES THE RIGHT TO MAKE CHANGES WITHOUT FURTHER NOTICE TO ANY PRODUCTS HEREIN TO IMPROVE RELIABILITY, FUNCTION, OR DESIGN. FAIRCHILD DOES NOT ASSUME ANY LIABILITY ARISING OUT OF THE APPLICATION OR USE OF ANY PRODUCT OR CIRCUIT DESCRIBED HEREIN; NEITHER DOES IT CONVEY ANY LICENSE UNDER ITS PATENT RIGHTS, NOR THE RIGHTS OF OTHERS. THESE SPECIFICATIONS DO NOT EXPAND THE TERMS OF FAIRCHILD'S WORLDWIDE TERMS AND CONDITIONS, SPECIFICALLY THE WARRANTY THEREIN, WHICH COVERS THESE PRODUCTS.

**LIFE SUPPORT POLICY**

FAIRCHILD'S PRODUCTS ARE NOT AUTHORIZED FOR USE AS CRITICAL COMPONENTS IN LIFE SUPPORT DEVICES OR SYSTEMS WITHOUT THE EXPRESS WRITTEN APPROVAL OF FAIRCHILD SEMICONDUCTOR CORPORATION.

As used herein:

1. Life support devices or systems are devices or systems which, (a) are intended for surgical implant into the body or (b) support or sustain life, and (c) whose failure to perform when properly used in accordance with instructions for use provided in the labeling, can be reasonably expected to result in a significant injury of the user.
2. A critical component in any component of a life support, device, or system whose failure to perform can be reasonably expected to cause the failure of the life support device or system, or to affect its safety or effectiveness.

**ANTI-COUNTERFEITING POLICY**

Fairchild Semiconductor Corporation's Anti-Counterfeiting Policy. Fairchild's Anti-Counterfeiting Policy is also stated on our external website, [www.fairchildsemi.com](http://www.fairchildsemi.com), under Sales Support.

Counterfeiting of semiconductor parts is a growing problem in the industry. All manufacturers of semiconductor products are experiencing counterfeiting of their parts. Customers who inadvertently purchase counterfeit parts experience many problems such as loss of brand reputation, substandard performance, failed applications, and increased cost of production and manufacturing delays. Fairchild is taking strong measures to protect ourselves and our customers from the proliferation of counterfeit parts. Fairchild strongly encourages customers to purchase Fairchild parts either directly from Fairchild or from Authorized Fairchild Distributors who are listed by country on our web page cited above. Products customers buy either from Fairchild directly or from Authorized Fairchild Distributors are genuine parts, have full traceability, meet Fairchild's quality standards for handling and storage and provide access to Fairchild's full range of up-to-date technical and product information. Fairchild and our Authorized Distributors will stand behind all warranties and will appropriately address any warranty issues that may arise. Fairchild will not provide any warranty coverage or other assistance for parts bought from Unauthorized Sources. Fairchild is committed to combat this global problem and encourage our customers to do their part in stopping this practice by buying direct or from authorized distributors.

**PRODUCT STATUS DEFINITIONS**

**Definition of Terms**

Datasheet Identification	Product Status	Definition
Advance Information	Formative / In Design	Datasheet contains the design specifications for product development. Specifications may change in any manner without notice.
Preliminary	First Production	Datasheet contains preliminary data; supplementary data will be published at a later date. Fairchild Semiconductor reserves the right to make changes at any time without notice to improve design.
No Identification Needed	Full Production	Datasheet contains final specifications. Fairchild Semiconductor reserves the right to make changes at any time without notice to improve the design.
Obsolete	Not In Production	Datasheet contains specifications on a product that is discontinued by Fairchild Semiconductor. The datasheet is for reference information only.

Rev. I64

ON Semiconductor and  are trademarks of Semiconductor Components Industries, LLC dba ON Semiconductor or its subsidiaries in the United States and/or other countries. ON Semiconductor owns the rights to a number of patents, trademarks, copyrights, trade secrets, and other intellectual property. A listing of ON Semiconductor's product/patent coverage may be accessed at [www.onsemi.com/site/pdf/Patent-Marking.pdf](http://www.onsemi.com/site/pdf/Patent-Marking.pdf). ON Semiconductor reserves the right to make changes without further notice to any products herein. ON Semiconductor makes no warranty, representation or guarantee regarding the suitability of its products for any particular purpose, nor does ON Semiconductor assume any liability arising out of the application or use of any product or circuit, and specifically disclaims any and all liability, including without limitation special, consequential or incidental damages. Buyer is responsible for its products and applications using ON Semiconductor products, including compliance with all laws, regulations and safety requirements or standards, regardless of any support or applications information provided by ON Semiconductor. "Typical" parameters which may be provided in ON Semiconductor data sheets and/or specifications can and do vary in different applications and actual performance may vary over time. All operating parameters, including "Typicals" must be validated for each customer application by customer's technical experts. ON Semiconductor does not convey any license under its patent rights nor the rights of others. ON Semiconductor products are not designed, intended, or authorized for use as a critical component in life support systems or any FDA Class 3 medical devices or medical devices with a same or similar classification in a foreign jurisdiction or any devices intended for implantation in the human body. Should Buyer purchase or use ON Semiconductor products for any such unintended or unauthorized application, Buyer shall indemnify and hold ON Semiconductor and its officers, employees, subsidiaries, affiliates, and distributors harmless against all claims, costs, damages, and expenses, and reasonable attorney fees arising out of, directly or indirectly, any claim of personal injury or death associated with such unintended or unauthorized use, even if such claim alleges that ON Semiconductor was negligent regarding the design or manufacture of the part. ON Semiconductor is an Equal Opportunity/Affirmative Action Employer. This literature is subject to all applicable copyright laws and is not for resale in any manner.

## PUBLICATION ORDERING INFORMATION

### LITERATURE FULFILLMENT:

Literature Distribution Center for ON Semiconductor  
19521 E. 32nd Pkwy, Aurora, Colorado 80011 USA  
**Phone:** 303-675-2175 or 800-344-3860 Toll Free USA/Canada  
**Fax:** 303-675-2176 or 800-344-3867 Toll Free USA/Canada  
**Email:** [orderlit@onsemi.com](mailto:orderlit@onsemi.com)

**N. American Technical Support:** 800-282-9855 Toll Free  
USA/Canada  
**Europe, Middle East and Africa Technical Support:**  
Phone: 421 33 790 2910  
**Japan Customer Focus Center**  
Phone: 81-3-5817-1050

**ON Semiconductor Website:** [www.onsemi.com](http://www.onsemi.com)  
**Order Literature:** <http://www.onsemi.com/orderlit>  
For additional information, please contact your local  
Sales Representative