



ON Semiconductor®

FFB20UP20DN-F085

10A, 200V Ultrafast Dual Rectifiers

Features

- High Reverse Voltage : $V_{RRM} = 200V$
- Avalanche Energy Rated
- Planar Construction

Applications

- Output Rectifiers
- Switching Mode Power Supply
- Free-wheeling diode for motor application
- Power switching circuits
- Qualified to AEC Q101
- RoHS Compliant



Description

The FFB20UP20DN-F085 is an ultrafast rectifier. It has a low forward voltage drop and is a silicon nitride passivated ion-implanted epitaxial planar construction.

This device is intended for use as a freewheeling/clamping rectifier in a variety of switching power supplies and other power switching applications. Its low stored charge and hyperfast recovery minimize ringing and electrical noise in many power switching circuits, thus reducing power loss in the switching transistors.

Pin Assignments

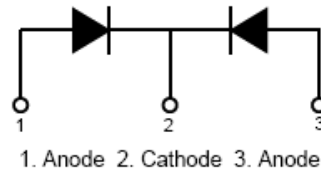
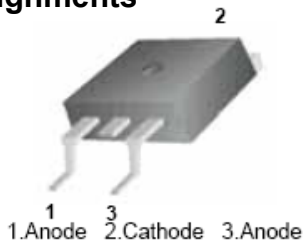

Absolute Maximum Ratings $T_C = 25^\circ C$ unless otherwise noted

Symbol	Parameter	Ratings	Units
V_{RRM}	Peak Repetitive Reverse Voltage	200	V
V_{RWM}	Working Peak Reverse Voltage	200	V
V_R	DC Blocking Voltage	200	V
$I_{f(av)}$	Average Rectified Forward Current @ $T_C = 155^\circ C$	10	A
I_{FSM}	Non-repetitive Peak Surge Current 60Hz Single Half-Sine Wave	100	A
T_J, T_{STG}	Operating Junction and Storage Temperature	-55 to +175	$^\circ C$

Thermal Characteristics $T_C = 25^\circ C$ unless otherwise noted

Symbol	Parameter	Max	Units
$R_{\theta JC}^1$	Maximum Thermal Resistance, Junction to Case	3.5	$^\circ C/W$

Package Marking and Ordering Information

Device Marking	Device	Package	Reel Size	Tape Width	Quantity
F20UP20DN	FFB20UP20DN-F085	TO-263	13"	24mm	800

Electrical Characteristics $T_C = 25^\circ\text{C}$ unless otherwise noted

Symbol	Parameter	Min.	Typ.	Max	Units
V_F^2	$I_F = 10\text{A}$	-	-	1.15	V
	$I_F = 10\text{A}$	-	-	1.0	V
I_R^2	$V_R = 200\text{V}$	-	-	10	μA
	$V_R = 200\text{V}$	-	-	250	μA
t_{rr}	$I_F = 1\text{A}$, $di/dt = 200\text{A}/\mu\text{s}$, $V_{CC} = 130\text{V}$	-	15	25	ns
	$I_F = 10\text{A}$, $di/dt = 200\text{A}/\mu\text{s}$, $V_{CC} = 130\text{V}$	-	27	40	ns
t_a	$I_F = 10\text{A}$, $di/dt = 200\text{A}/\mu\text{s}$, $V_{CC} = 130\text{V}$	-	21	-	ns
t_b		-	6	-	ns
Q_{rr}		-	50	-	nC
W_{AVL}	Avalanche Energy ($L = 20\text{mH}$)	10	-	-	mJ

Notes
 1: R_{th_jc} value is specified for each die
 2: Pulse: Test Pulse width = 300S, Duty Cycle = 2%

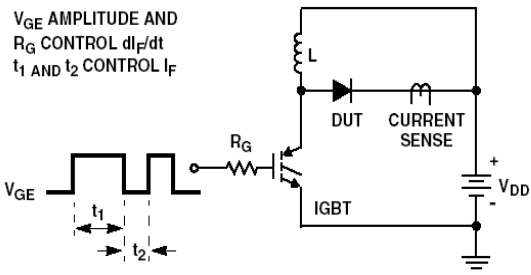

t_{rr} TEST CIRCUIT

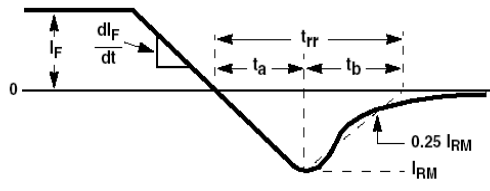

t_{rr} WAVEFORMS AND DEFINITIONS

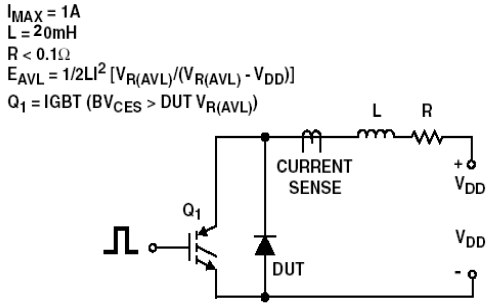

AVALANCHE ENERGY TEST CIRCUIT

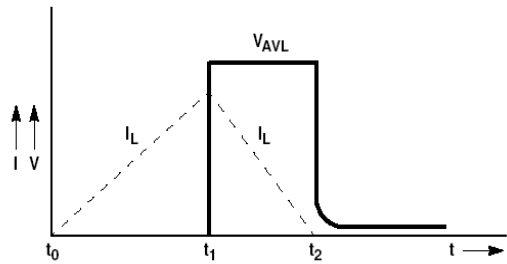

AVALANCHE CURRENT AND VOLTAGE WAVEFORMS

Typical Characteristics $T_C = 25^\circ\text{C}$ unless otherwise noted

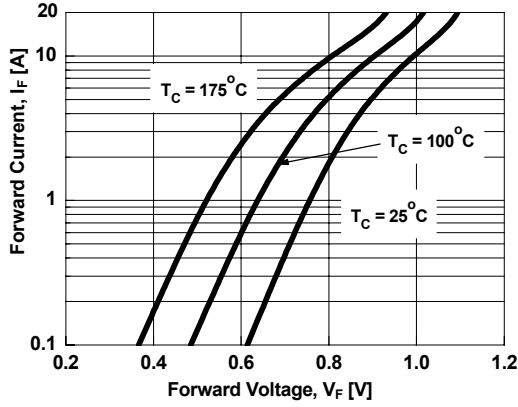

Figure 1. Typical Forward Voltage Drop

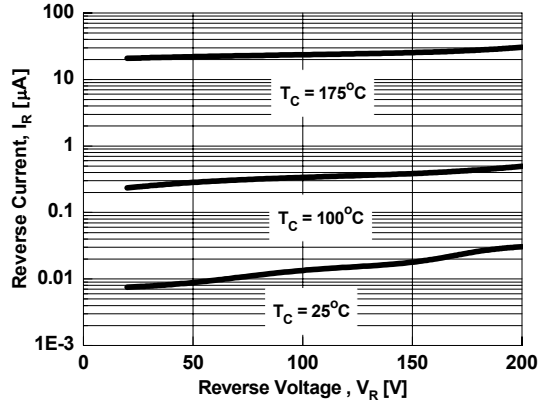

Figure 2. Typical Reverse Current

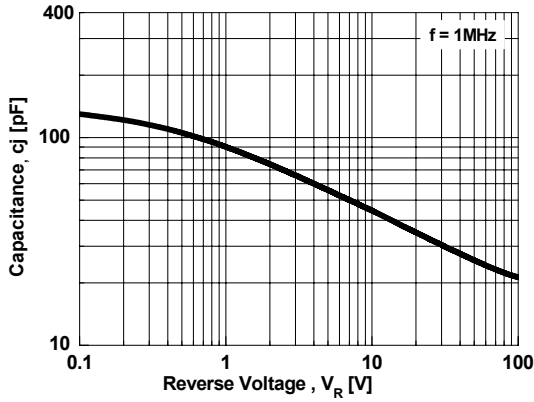

Figure 3. Typical Junction Capacitance

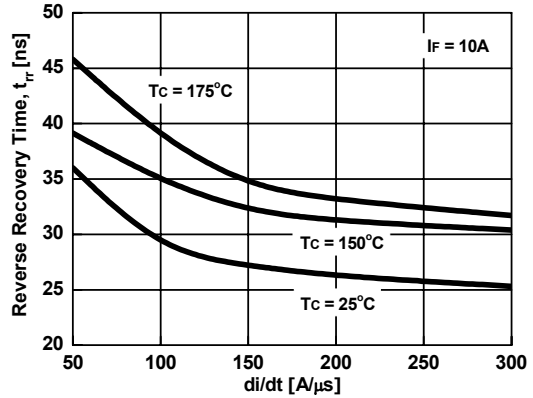

Figure 4. Typical Reverse Recovery Time

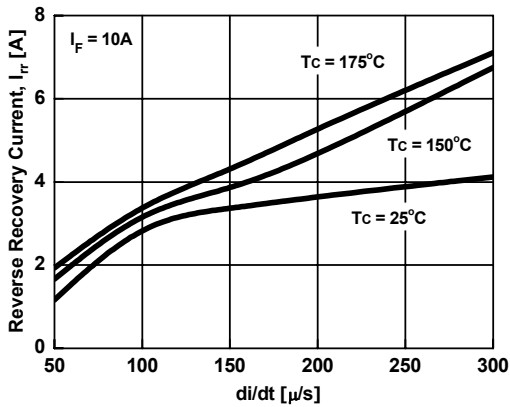

Figure 5. Typical Reverse Recovery Current

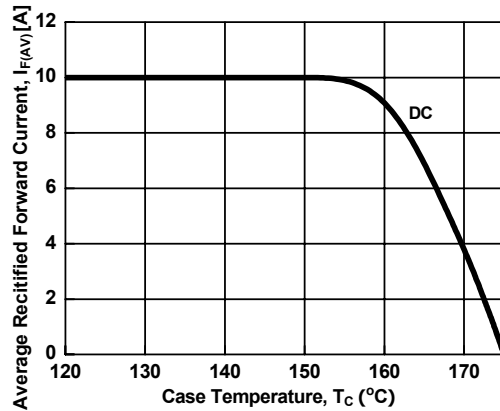

Figure 6. Case Temperature, T_C [$^\circ\text{C}$]

ON Semiconductor and  are trademarks of Semiconductor Components Industries, LLC dba ON Semiconductor or its subsidiaries in the United States and/or other countries. ON Semiconductor owns the rights to a number of patents, trademarks, copyrights, trade secrets, and other intellectual property. A listing of ON Semiconductor's product/patent coverage may be accessed at www.onsemi.com/site/pdf/Patent-Marking.pdf. ON Semiconductor reserves the right to make changes without further notice to any products herein. ON Semiconductor makes no warranty, representation or guarantee regarding the suitability of its products for any particular purpose, nor does ON Semiconductor assume any liability arising out of the application or use of any product or circuit, and specifically disclaims any and all liability, including without limitation special, consequential or incidental damages. Buyer is responsible for its products and applications using ON Semiconductor products, including compliance with all laws, regulations and safety requirements or standards, regardless of any support or applications information provided by ON Semiconductor. "Typical" parameters which may be provided in ON Semiconductor data sheets and/or specifications can and do vary in different applications and actual performance may vary over time. All operating parameters, including "Typicals" must be validated for each customer application by customer's technical experts. ON Semiconductor does not convey any license under its patent rights nor the rights of others. ON Semiconductor products are not designed, intended, or authorized for use as a critical component in life support systems or any FDA Class 3 medical devices or medical devices with a same or similar classification in a foreign jurisdiction or any devices intended for implantation in the human body. Should Buyer purchase or use ON Semiconductor products for any such unintended or unauthorized application, Buyer shall indemnify and hold ON Semiconductor and its officers, employees, subsidiaries, affiliates, and distributors harmless against all claims, costs, damages, and expenses, and reasonable attorney fees arising out of, directly or indirectly, any claim of personal injury or death associated with such unintended or unauthorized use, even if such claim alleges that ON Semiconductor was negligent regarding the design or manufacture of the part. ON Semiconductor is an Equal Opportunity/Affirmative Action Employer. This literature is subject to all applicable copyright laws and is not for resale in any manner.

PUBLICATION ORDERING INFORMATION

LITERATURE FULFILLMENT:

Literature Distribution Center for ON Semiconductor
19521 E. 32nd Pkwy, Aurora, Colorado 80011 USA
Phone: 303-675-2175 or 800-344-3860 Toll Free USA/Canada
Fax: 303-675-2176 or 800-344-3867 Toll Free USA/Canada
Email: orderlit@onsemi.com

N. American Technical Support: 800-282-9855 Toll Free
USA/Canada
Europe, Middle East and Africa Technical Support:
Phone: 421 33 790 2910
Japan Customer Focus Center
Phone: 81-3-5817-1050

ON Semiconductor Website: www.onsemi.com
Order Literature: <http://www.onsemi.com/orderlit>
For additional information, please contact your local
Sales Representative