

# FFPF30UP20S

## 30 A, 200 V, Ultrafast Diode

The FFPF30UP20S is a ultrafast diode with low forward voltage drop. This device is intended for use as freewheeling and clamping diodes in a variety of switching power supplies and other power switching applications. It is specially suited for use in switching power supplies and industrial application.

### Features

- Ultrafast Recovery  $t_{rr} = 50$  ns (@  $I_F = 30$  A)
- Max Forward Voltage,  $V_F = 1.15$  V (@  $T_C = 25^\circ\text{C}$ )
- Reverse Voltage,  $V_{RRM} = 200$  V
- Avalanche Energy Rated
- This Device is Pb-Free and is RoHS Compliant

### Applications

- Output Rectifiers
- SMPS, Power Switching Circuits
- Free-Wheeling Diode for Motor Application

### ABSOLUTE MAXIMUM RATINGS

$T_C = 25^\circ\text{C}$  unless otherwise noted

Symbol	Parameter	Rating	Unit
$V_{RRM}$	Peak Repetitive Reverse Voltage	200	V
$V_{RWM}$	Working Peak Reverse Voltage	200	V
$V_R$	DC Blocking Voltage	200	V
$I_{F(AV)}$	Average Rectified Forward Current @ $T_C = 102^\circ\text{C}$	30	A
$I_{FSM}$	Non-repetitive Peak Surge Current 60 Hz Single Half-Sine Wave	300	A
$T_J, T_{STG}$	Operating Junction and Storage Temperature	-65 to +175	$^\circ\text{C}$

Stresses exceeding those listed in the Maximum Ratings table may damage the device. If any of these limits are exceeded, device functionality should not be assumed, damage may occur and reliability may be affected.



ON Semiconductor®

[www.onsemi.com](http://www.onsemi.com)

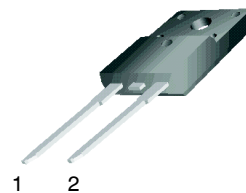
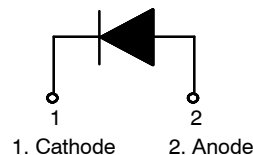

TO-220, 2-Lead  
CASE 221AS

### MARKING DIAGRAM

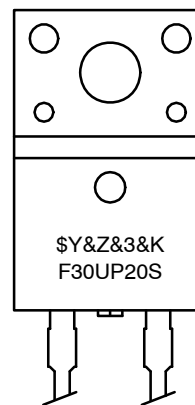

\$Y                    = ON Semiconductor Logo  
&Z&3                = Data Code (Year & Week)  
&K                    = Lot  
F30UP20S           = Specific Device Code

### ORDERING INFORMATION

See detailed ordering and shipping information on page 2 of this data sheet.

# FFPF30UP20S

## THERMAL CHARACTERISTICS

Symbol	Parameter	Max.	Unit
$R_{\theta JC}$	Maximum Thermal Resistance, Junction to Case	3.0	$^{\circ}C/W$

## PACKAGE MARKING AND ORDERING INFORMATION

Part Number	Top Mark	Package	Packing Method	Reel Size	Tape Width	Quantity
FFPF30UP20STU	F30UP20S	TO-220F-2L	Tube	N/A	N/A	50

## ELECTRICAL CHARACTERISTICS $T_C = 25^{\circ}C$ unless otherwise noted

Parameter	Conditions	Min.	Typ.	Max.	Unit
$V_F$ (Note 1)	$I_F = 30\text{ A}$ $I_F = 30\text{ A}$	$T_C = 25^{\circ}C$ $T_C = 125^{\circ}C$	- -	1.15 1.0	V V
$I_R$ (Note 1)	$V_R = 200\text{ V}$ $V_R = 200\text{ V}$	$T_C = 25^{\circ}C$ $T_C = 125^{\circ}C$	- -	100 500	$\mu A$ $\mu A$
$t_{rr}$	$I_F = 1\text{ A}$ , $di_F/dt = 100\text{ A}/\mu s$ , $V_{CC} = 30\text{ V}$ $I_F = 30\text{ A}$ , $di_F/dt = 200\text{ A}/\mu s$ , $V_{CC} = 130\text{ V}$	$T_C = 25^{\circ}C$ $T_C = 25^{\circ}C$	- -	40 50	ns ns
$t_a$ $t_b$ $Q_{rr}$	$I_F = 30\text{ A}$ , $di_F/dt = 200\text{ A}/\mu s$ , $V_{CC} = 130\text{ V}$	$T_C = 25^{\circ}C$ $T_C = 25^{\circ}C$ $T_C = 25^{\circ}C$	- - -	22 14 67	ns ns nC
$W_{AVL}$	Avalanche Energy ( $L = 40\text{ mH}$ )	20	-	-	mJ

Product parametric performance is indicated in the Electrical Characteristics for the listed test conditions, unless otherwise noted. Product performance may not be indicated by the Electrical Characteristics if operated under different conditions.

1. Pulse: Test Pulse Width = 300  $\mu s$ , Duty Cycle = 2%

## Test Circuit and Waveforms

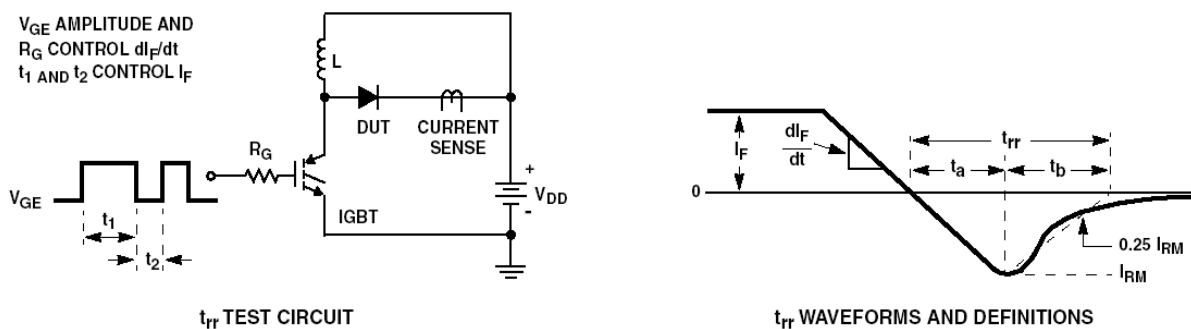

Figure 1. Diode Reverse Recovery Test Circuit & Waveform

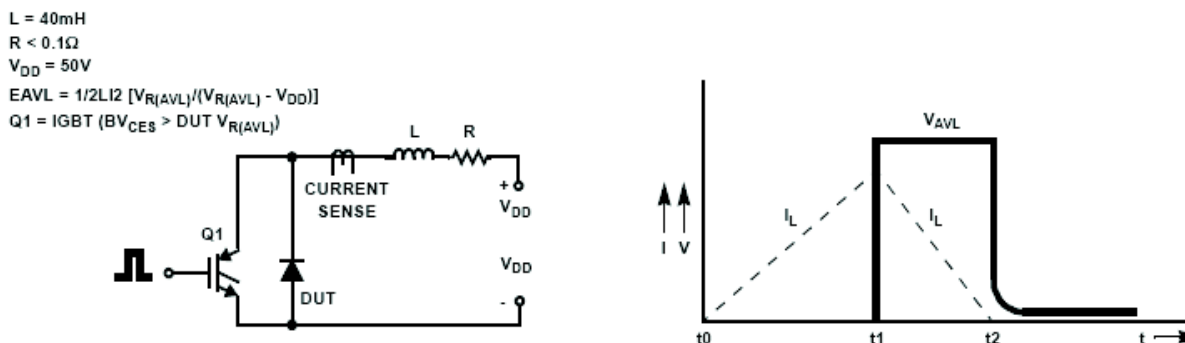

Figure 2. Unclamped Inductive Switching Test Circuit & Waveform

# FFPF30UP20S

## TYPICAL CHARACTERISTICS

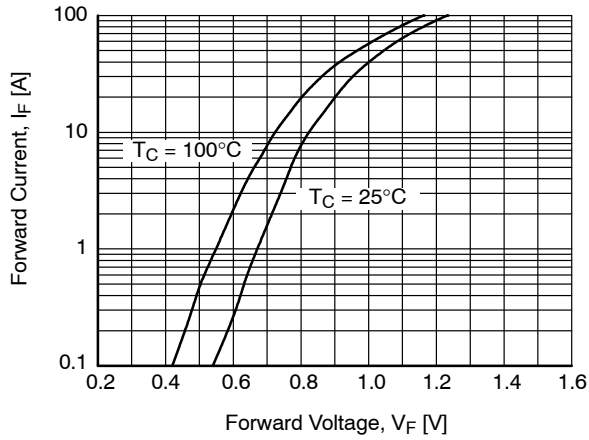

Figure 3. Typical Forward Voltage Drop

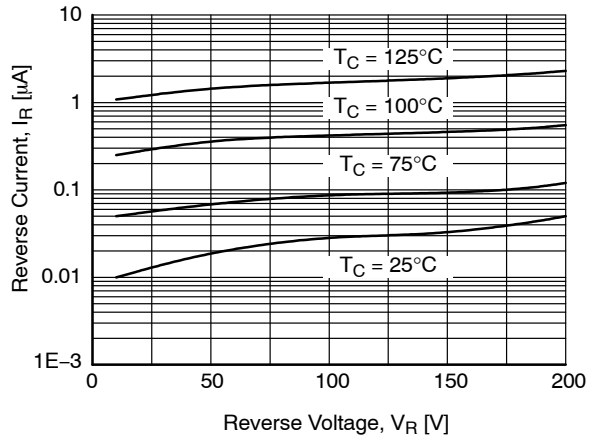

Figure 4. Typical Reverse Current

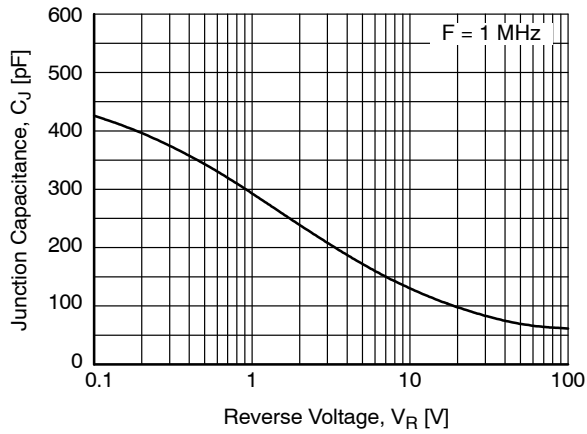

Figure 5. Typical Junction Capacitance

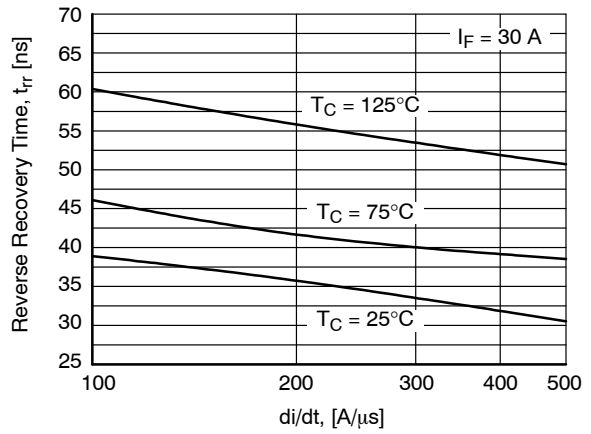

Figure 6. Typical Reverse Recovery Time

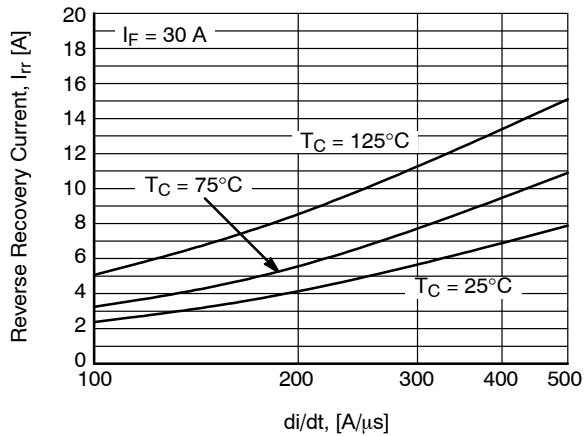

Figure 7. Typical Reverse Recovery Current

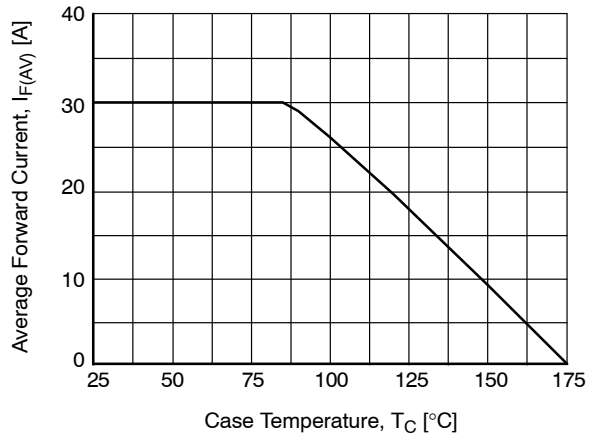

Figure 8. Forward Current Deration Curve

**MECHANICAL CASE OUTLINE**  
**PACKAGE DIMENSIONS**



TO-220 Fullpack, 2-Lead / TO-220F-2FS  
CASE 221AS  
ISSUE 0

DATE 29 FEB 2012

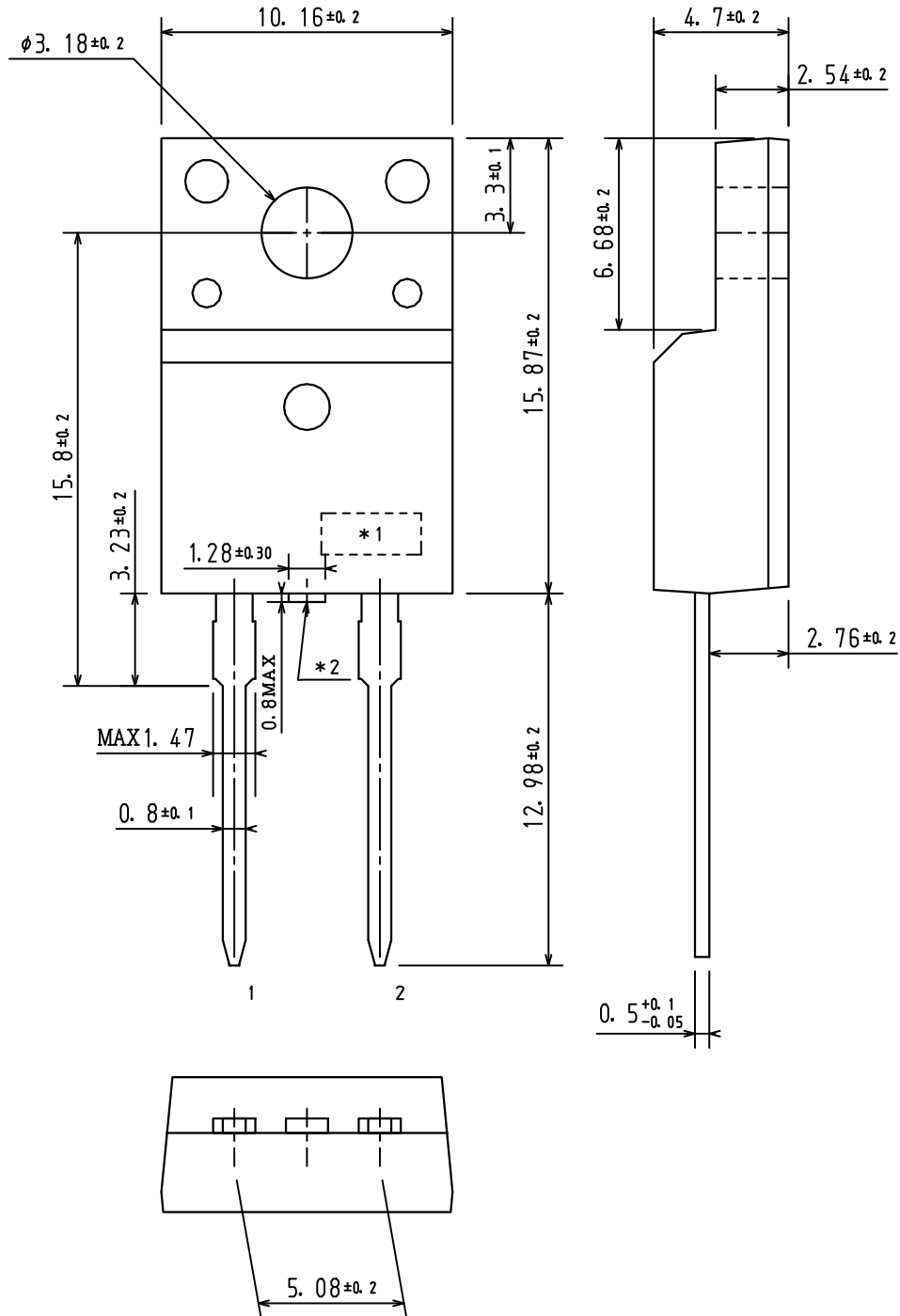

<b>DOCUMENT NUMBER:</b>	<b>98AON67438E</b>	Electronic versions are uncontrolled except when accessed directly from the Document Repository. Printed versions are uncontrolled except when stamped "CONTROLLED COPY" in red.
<b>STATUS:</b>	<b>ON SEMICONDUCTOR STANDARD</b>	
<b>NEW STANDARD:</b>		
<b>DESCRIPTION:</b>	<b>TO-220 FULLPACK, 2-LEAD / TO-220F-2FS</b>	<b>PAGE 1 OF 2</b>



ON Semiconductor and  are trademarks of Semiconductor Components Industries, LLC dba ON Semiconductor or its subsidiaries in the United States and/or other countries. ON Semiconductor owns the rights to a number of patents, trademarks, copyrights, trade secrets, and other intellectual property. A listing of ON Semiconductor's product/patent coverage may be accessed at [www.onsemi.com/site/pdf/Patent-Marking.pdf](http://www.onsemi.com/site/pdf/Patent-Marking.pdf). ON Semiconductor reserves the right to make changes without further notice to any products herein. ON Semiconductor makes no warranty, representation or guarantee regarding the suitability of its products for any particular purpose, nor does ON Semiconductor assume any liability arising out of the application or use of any product or circuit, and specifically disclaims any and all liability, including without limitation special, consequential or incidental damages. Buyer is responsible for its products and applications using ON Semiconductor products, including compliance with all laws, regulations and safety requirements or standards, regardless of any support or applications information provided by ON Semiconductor. "Typical" parameters which may be provided in ON Semiconductor data sheets and/or specifications can and do vary in different applications and actual performance may vary over time. All operating parameters, including "Typicals" must be validated for each customer application by customer's technical experts. ON Semiconductor does not convey any license under its patent rights nor the rights of others. ON Semiconductor products are not designed, intended, or authorized for use as a critical component in life support systems or any FDA Class 3 medical devices or medical devices with a same or similar classification in a foreign jurisdiction or any devices intended for implantation in the human body. Should Buyer purchase or use ON Semiconductor products for any such unintended or unauthorized application, Buyer shall indemnify and hold ON Semiconductor and its officers, employees, subsidiaries, affiliates, and distributors harmless against all claims, costs, damages, and expenses, and reasonable attorney fees arising out of, directly or indirectly, any claim of personal injury or death associated with such unintended or unauthorized use, even if such claim alleges that ON Semiconductor was negligent regarding the design or manufacture of the part. ON Semiconductor is an Equal Opportunity/Affirmative Action Employer. This literature is subject to all applicable copyright laws and is not for resale in any manner.

## PUBLICATION ORDERING INFORMATION

### LITERATURE FULFILLMENT:

Literature Distribution Center for ON Semiconductor  
19521 E. 32nd Pkwy, Aurora, Colorado 80011 USA  
**Phone:** 303-675-2175 or 800-344-3860 Toll Free USA/Canada  
**Fax:** 303-675-2176 or 800-344-3867 Toll Free USA/Canada  
**Email:** [orderlit@onsemi.com](mailto:orderlit@onsemi.com)

**N. American Technical Support:** 800-282-9855 Toll Free  
USA/Canada  
**Europe, Middle East and Africa Technical Support:**  
Phone: 421 33 790 2910

**ON Semiconductor Website:** [www.onsemi.com](http://www.onsemi.com)

**Order Literature:** <http://www.onsemi.com/orderlit>

For additional information, please contact your local  
Sales Representative