

# FFSB0665B

## Silicon Carbide Schottky Diode

### 650 V, 6 A

Silicon Carbide (SiC) Schottky Diodes use a completely new technology that provides superior switching performance and higher reliability compared to Silicon. No reverse recovery current, temperature independent switching characteristics, and excellent thermal performance sets Silicon Carbide as the next generation of power semiconductor. System benefits include highest efficiency, faster operating frequency, increased power density, reduced EMI, and reduced system size and cost.

#### Features

- Max Junction Temperature 175°C
- Avalanche Rated 24.5 mJ
- High Surge Current Capacity
- Positive Temperature Coefficient
- Ease of Paralleling
- No Reverse Recovery / No Forward Recovery
- These Devices are Pb-Free, Halogen Free/BFR Free and are RoHS Compliant

#### Applications

- General Purpose
- SMPS, Solar Inverter, UPS
- Power Switching Circuits

#### MAXIMUM RATINGS (T<sub>J</sub> = 25°C unless otherwise noted)

Parameter	Symbol	Value	Unit
Peak Repetitive Reverse Voltage	V <sub>RRM</sub>	650	V
Single Pulse Avalanche Energy (T <sub>J</sub> = 25°C, I <sub>L(pk)</sub> = 9.9 A, L = 0.5 mH, V = 50 V)	E <sub>AS</sub>	24.5	mJ
Continuous Rectified Forward Current	@ T <sub>C</sub> < 150	I <sub>F</sub>	6.0 A
	@ T <sub>C</sub> < 135		8.0
Non-Repetitive Peak Forward Surge Current	T <sub>C</sub> = 25°C t <sub>p</sub> = 10 μs	I <sub>FM</sub>	523 A
	T <sub>C</sub> = 150°C t <sub>p</sub> = 10 μs		467
Non-Repetitive Forward Surge Current (Half-Sine Pulse)	T <sub>C</sub> = 25°C t <sub>p</sub> = 8.3 ms	I <sub>FSM</sub>	45 A
Power Dissipation	T <sub>C</sub> = 25°C	P <sub>tot</sub>	61 W
	T <sub>C</sub> = 150°C		10
Operating Junction and Storage Temperature Range	T <sub>J</sub> , T <sub>stg</sub>	-55 to +175	°C

Stresses exceeding those listed in the Maximum Ratings table may damage the device. If any of these limits are exceeded, device functionality should not be assumed, damage may occur and reliability may be affected.

#### THERMAL CHARACTERISTICS

Parameter	Symbol	Value	Unit
Thermal Resistance, Junction-to-Case, Max.	R <sub>θJC</sub>	2.46	°C/W



ON Semiconductor®

[www.onsemi.com](http://www.onsemi.com)

V <sub>RRM</sub>	I <sub>F</sub>
650 V	6.0 A

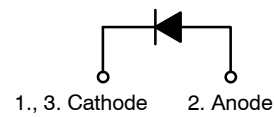

Schottky Diode

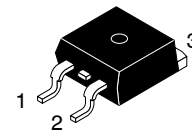

D<sup>2</sup>PAK-3  
TO-263  
CASE 418BK

#### MARKING DIAGRAM

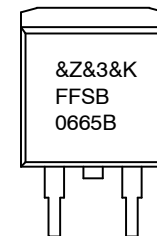

&Z = Assembly Plant Code  
 &3 = Numeric Date Code  
 &K = Lot Code  
 FFSB0665B = Specific Device Code

#### ORDERING INFORMATION

See detailed ordering and shipping information on page 2 of this data sheet.

# FFSB0665B

## ELECTRICAL CHARACTERISTICS ( $T_J = 25^\circ\text{C}$ unless otherwise noted)

Parameter	Symbol	Test Conditions	Min	Typ	Max	Unit
-----------	--------	-----------------	-----	-----	-----	------

### ON CHARACTERISTICS

Forward Voltage	$V_F$	$I_F = 6.0\text{ A}, T_J = 25^\circ\text{C}$		1.38	1.7	V
		$I_F = 6.0\text{ A}, T_J = 125^\circ\text{C}$		1.53	2.0	
		$I_F = 6.0\text{ A}, T_J = 175^\circ\text{C}$		1.67	2.4	
Reverse Current	$I_R$	$V_R = 650\text{ V}, T_J = 25^\circ\text{C}$		0.5	40	$\mu\text{A}$
		$V_R = 650\text{ V}, T_J = 125^\circ\text{C}$		1.0	80	
		$V_R = 650\text{ V}, T_J = 175^\circ\text{C}$		2.0	160	

### CHARGES, CAPACITANCES & GATE RESISTANCE

Total Capacitive Charge	$Q_C$	$V_C = 400\text{ V}$		16		nC
	$C_{\text{tot}}$	$V_R = 1\text{ V}, f = 100\text{ kHz}$		259		pF
		$V_R = 200\text{ V}, f = 100\text{ kHz}$		29		
		$V_R = 400\text{ V}, f = 100\text{ kHz}$		22		

Product parametric performance is indicated in the Electrical Characteristics for the listed test conditions, unless otherwise noted. Product performance may not be indicated by the Electrical Characteristics if operated under different conditions.

### PACKAGE MARKING AND ORDERING INFORMATION

Part Number	Top Marking	Package	Packing Method	Reel Size	Tape Width	Quantity
FFSB0665B	FFSB0665B	D <sup>2</sup> PAK	Tape & Reel†	330 mm	24 mm	800 Units

†For information on tape and reel specifications, including part orientation and tape sizes, please refer to our Tape and Reel Packaging Specifications Brochure, [BRD8011/D](#).

TYPICAL CHARACTERISTICS

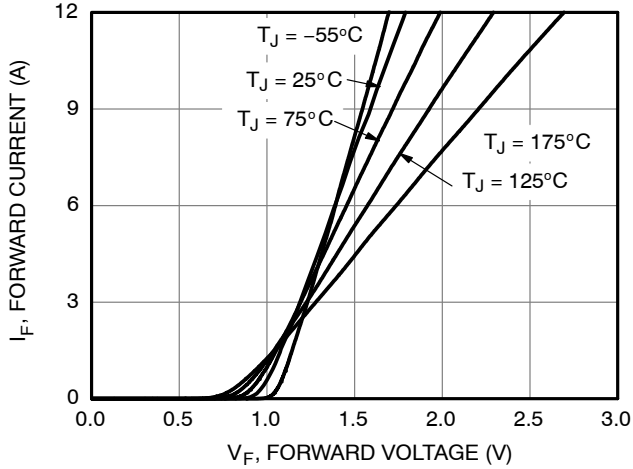

Figure 1. Forward Characteristics

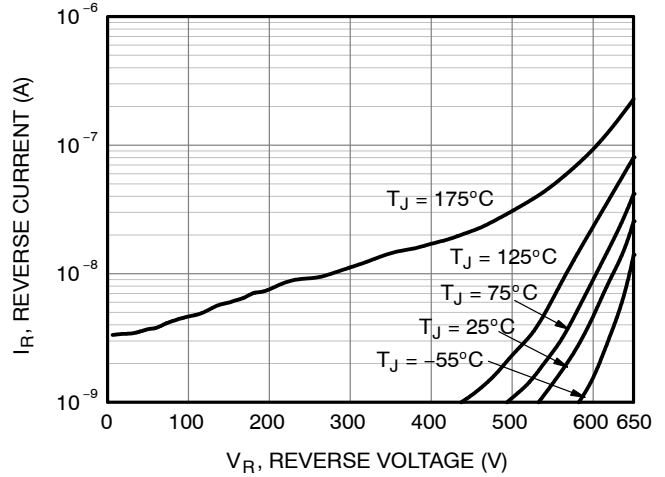

Figure 2. Reverse Characteristics

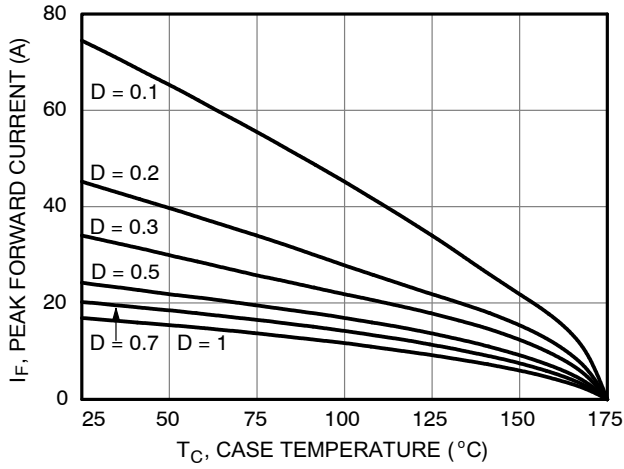

Figure 3. Current Derating

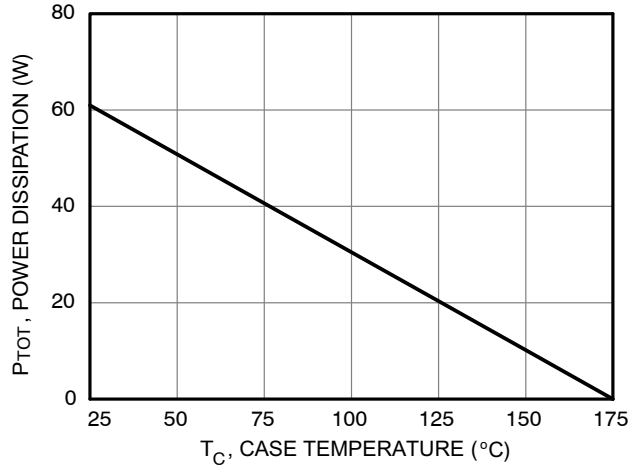

Figure 4. Power Derating

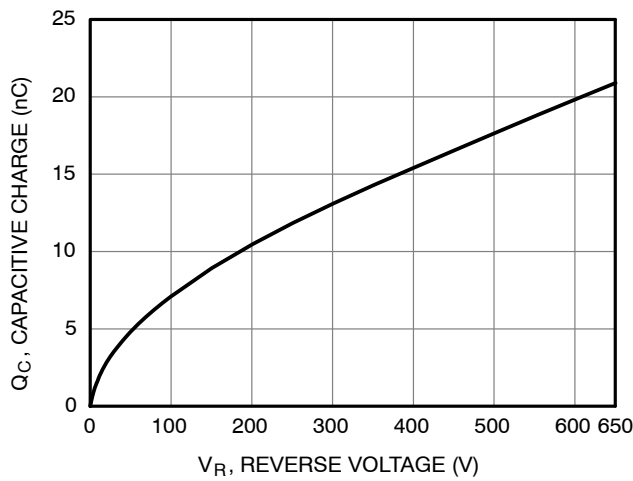

Figure 5. Capacitive Charge vs. Reverse Voltage

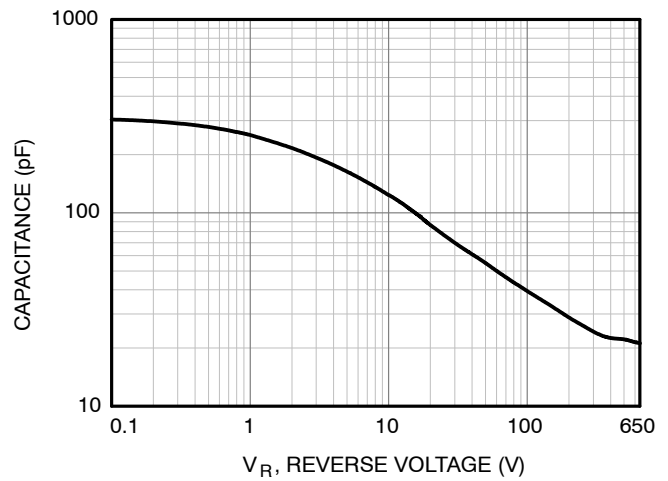

Figure 6. Capacitance vs. Reverse Voltage

TYPICAL CHARACTERISTICS

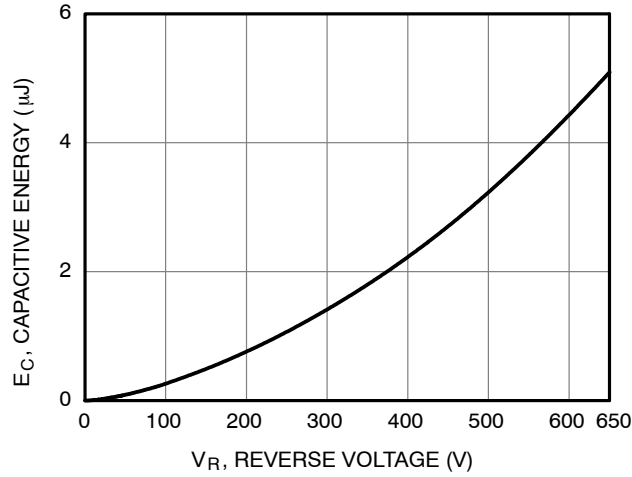

Figure 7. Capacitance Stored Energy

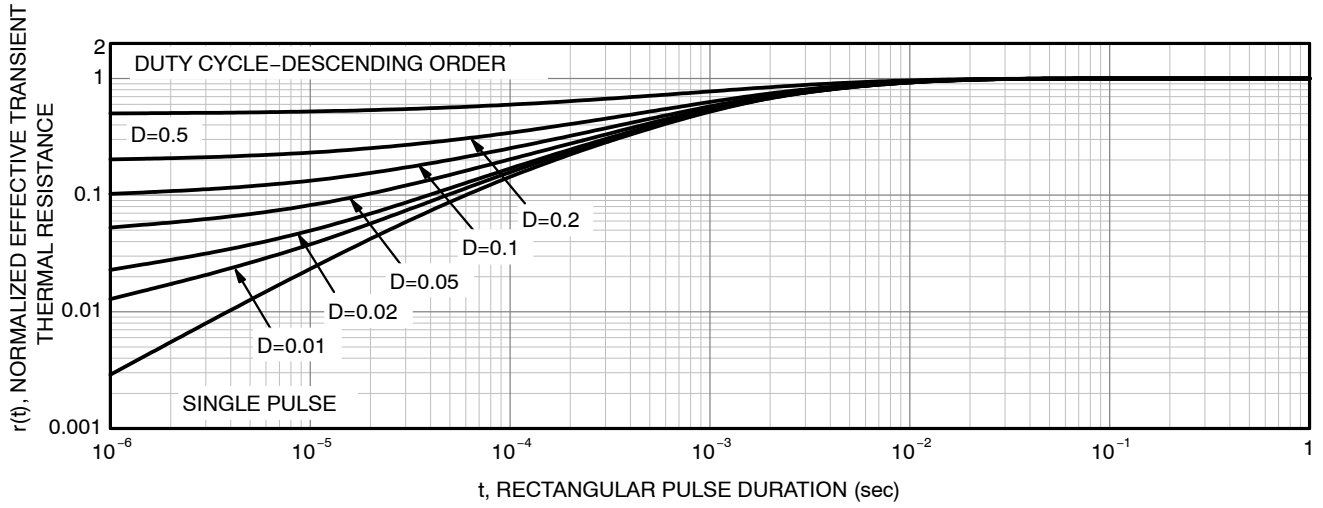
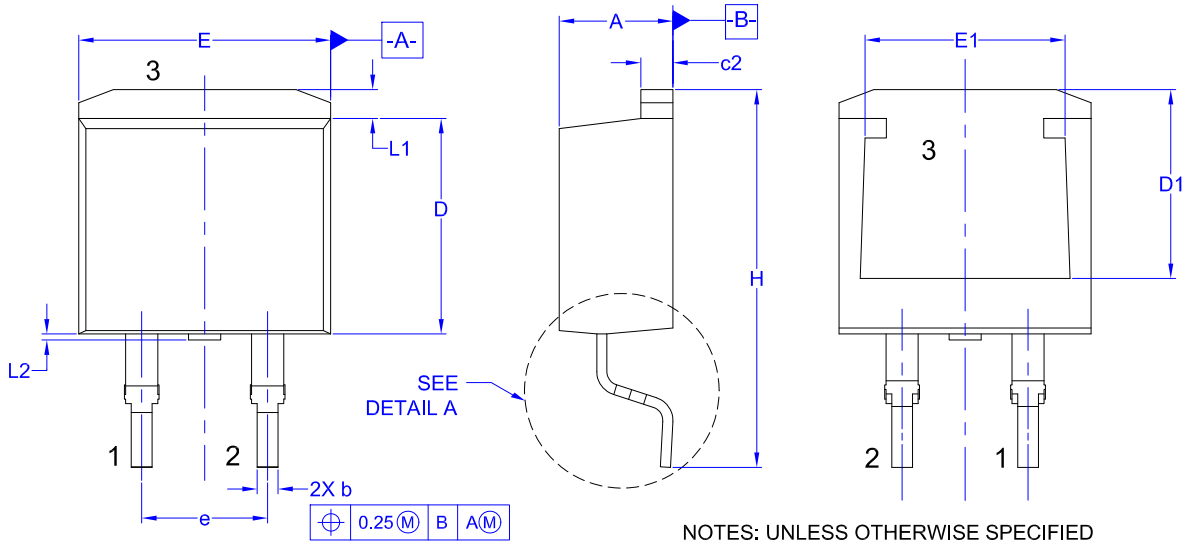

Figure 8. Junction-to-Case Transient Thermal Response

# FFSB0665B

## PACKAGE DIMENSIONS

**D<sup>2</sup>PAK2 (TO-263-2L)**  
 CASE 418BK  
 ISSUE O



- NOTES: UNLESS OTHERWISE SPECIFIED  
 A) ALL DIMENSIONS ARE IN MILLIMETERS.  
 B) REFERENCE JEDEC, TO-263, VARIATION AB.  
 C) DIMENSIONING AND TOLERANCING PER DIMENSIONING AND TOLERANCING PER ASME Y14.5 - 2009.  
 D) LANDPATTERN RECOMMENDATION PER IPC TO254P1524X482-3N

**DETAIL A, ROTATED 90°**  
 SCALE: 2X

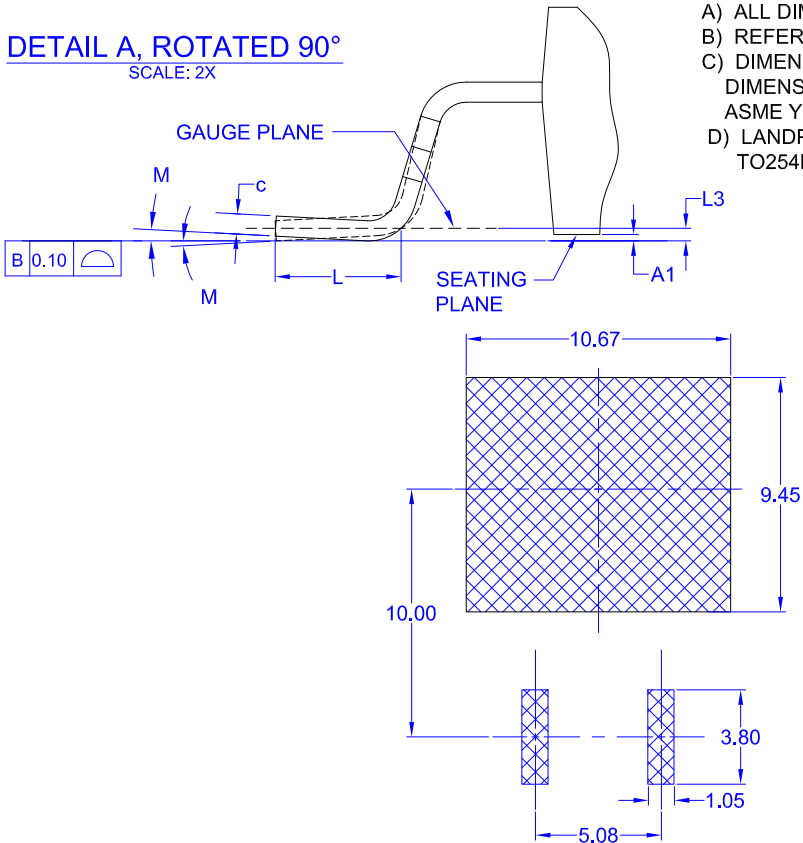

LAND PATTERN RECOMMENDATION  
 UNLESS NOTED, ALL DIMS TYPICAL

DIM	MILLIMETERS		
	MIN	NOM	MAX
A	4.06	4.57	4.83
A1	0.00	0.10	0.25
b	0.51	0.81	0.99
c	0.30	0.407	0.74
c2	1.14	1.30	1.65
D	8.38	8.69	9.65
D1	7.30	7.80	8.30
E	9.65	10.16	10.67
E1	8.00	8.62	9.00
e	5.08 BSC		
H	14.60	15.35	15.88
L	1.78	2.54	2.79
L1	0.90	1.29	1.68
L2	0.00	0.15	0.25
L3	0.25 BSC		
M	0°	4°	8°

ON Semiconductor and  are trademarks of Semiconductor Components Industries, LLC dba ON Semiconductor or its subsidiaries in the United States and/or other countries. ON Semiconductor owns the rights to a number of patents, trademarks, copyrights, trade secrets, and other intellectual property. A listing of ON Semiconductor's product/patent coverage may be accessed at [www.onsemi.com/site/pdf/Patent-Marking.pdf](http://www.onsemi.com/site/pdf/Patent-Marking.pdf). ON Semiconductor reserves the right to make changes without further notice to any products herein. ON Semiconductor makes no warranty, representation or guarantee regarding the suitability of its products for any particular purpose, nor does ON Semiconductor assume any liability arising out of the application or use of any product or circuit, and specifically disclaims any and all liability, including without limitation special, consequential or incidental damages. Buyer is responsible for its products and applications using ON Semiconductor products, including compliance with all laws, regulations and safety requirements or standards, regardless of any support or applications information provided by ON Semiconductor. "Typical" parameters which may be provided in ON Semiconductor data sheets and/or specifications can and do vary in different applications and actual performance may vary over time. All operating parameters, including "Typicals" must be validated for each customer application by customer's technical experts. ON Semiconductor does not convey any license under its patent rights nor the rights of others. ON Semiconductor products are not designed, intended, or authorized for use as a critical component in life support systems or any FDA Class 3 medical devices or medical devices with a same or similar classification in a foreign jurisdiction or any devices intended for implantation in the human body. Should Buyer purchase or use ON Semiconductor products for any such unintended or unauthorized application, Buyer shall indemnify and hold ON Semiconductor and its officers, employees, subsidiaries, affiliates, and distributors harmless against all claims, costs, damages, and expenses, and reasonable attorney fees arising out of, directly or indirectly, any claim of personal injury or death associated with such unintended or unauthorized use, even if such claim alleges that ON Semiconductor was negligent regarding the design or manufacture of the part. ON Semiconductor is an Equal Opportunity/Affirmative Action Employer. This literature is subject to all applicable copyright laws and is not for resale in any manner.

**PUBLICATION ORDERING INFORMATION**

**LITERATURE FULFILLMENT:**

Literature Distribution Center for ON Semiconductor  
19521 E. 32nd Pkwy, Aurora, Colorado 80011 USA  
**Phone:** 303-675-2175 or 800-344-3860 Toll Free USA/Canada  
**Fax:** 303-675-2176 or 800-344-3867 Toll Free USA/Canada  
**Email:** [orderlit@onsemi.com](mailto:orderlit@onsemi.com)

**N. American Technical Support:** 800-282-9855 Toll Free  
USA/Canada  
**Europe, Middle East and Africa Technical Support:**  
Phone: 421 33 790 2910

**ON Semiconductor Website:** [www.onsemi.com](http://www.onsemi.com)  
**Order Literature:** <http://www.onsemi.com/orderlit>

For additional information, please contact your local Sales Representative