

FFSH3065B-F085

Silicon Carbide Schottky Diode, 650 V, 30 A

Description

Silicon Carbide (SiC) Schottky Diodes use a completely new technology that provides superior switching performance and higher reliability compared to Silicon. No reverse recovery current, temperature independent switching characteristics, and excellent thermal performance sets Silicon Carbide as the next generation of power semiconductor. System benefits include highest efficiency, faster operating frequency, increased power density, reduced EMI, and reduced system size & cost.

Features

- Max Junction Temperature 175°C
- Avalanche Rated 144 mJ
- High Surge Current Capacity
- Positive Temperature Coefficient
- Ease of Paralleling
- No Reverse Recovery/No Forward Recovery
- AEC-Q101 Qualified
- These Devices are Pb-Free, Halogen Free/BFR Free and are RoHS Compliant

Applications

- Automotive HEV-EV Onboard Chargers
- Automotive HEV-EV DC-DC Converters



ON Semiconductor®

www.onsemi.com

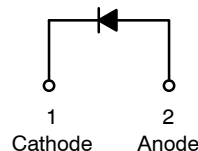

Schottky Diode

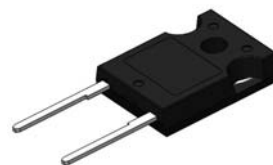

TO-247-2LD
CASE 340CL

MARKING DIAGRAM



| | |
|-----------|-------------------------|
| \$Y | = ON Semiconductor Logo |
| &Z | = Assembly Plant Code |
| &3 | = Numeric Date Code |
| &K | = Lot Code |
| FFSH3065B | = Specific Device Code |

ORDERING INFORMATION

See detailed ordering and shipping information on page 2 of this data sheet.

FFSH3065B-F085

ABSOLUTE MAXIMUM RATINGS (T_C = 25°C unless otherwise noted)

| Symbol | Parameter | Value | Unit | |
|-----------------------------------|---|--|------|---|
| V _{RRM} | Peak Repetitive Reverse Voltage | 650 | V | |
| E _{AS} | Single Pulse Avalanche Energy (Note 1) | 144 | mJ | |
| I _F | Continuous Rectified Forward Current @ T _C < 146°C | 30 | A | |
| | Continuous Rectified Forward Current @ T _C < 135°C | 37 | | |
| I _{F, Max} | Non-Repetitive Peak Forward Surge Current | T _C = 25°C, 10 μs | 1100 | A |
| | | T _C = 150°C, 10 μs | 1000 | A |
| I _{F, SM} | Non-Repetitive Forward Surge Current T _C = 25°C | Half-Sine Pulse, t _p = 8.3 ms | 110 | A |
| P _{tot} | Power Dissipation | T _C = 25°C | 268 | W |
| | | T _C = 150°C | 45 | W |
| T _J , T _{STG} | Operating and Storage Temperature Range | -55 to +175 | °C | |
| | TO247 Mounting Torque, M3 Screw | 60 | Ncm | |

Stresses exceeding those listed in the Maximum Ratings table may damage the device. If any of these limits are exceeded, device functionality should not be assumed, damage may occur and reliability may be affected.

1. E_{AS} of 144 mJ is based on starting T_J = 25°C, L = 0.5 mH, I_{AS} = 24 A, V = 50 V.

THERMAL CHARACTERISTICS

| Symbol | Parameter | Value | Unit |
|------------------|---|-------|------|
| R _{θJC} | Thermal Resistance, Junction to Case, Max | 0.56 | °C/W |

ELECTRICAL CHARACTERISTICS (T_C = 25°C unless otherwise noted)

| Symbol | Parameter | Test Condition | Min | Typ | Max | Unit |
|----------------|-------------------------|--|-----|------|-----|------|
| V _F | Forward Voltage | I _F = 30 A, T _C = 25°C | - | 1.38 | 1.7 | V |
| | | I _F = 30 A, T _C = 125°C | - | 1.6 | 2.0 | |
| | | I _F = 30 A, T _C = 175°C | - | 1.72 | 2.4 | |
| I _R | Reverse Current | V _R = 650 V, T _C = 25°C | - | 0.5 | 40 | μA |
| | | V _R = 650 V, T _C = 125°C | - | 1 | 80 | |
| | | V _R = 650 V, T _C = 175°C | - | 2 | 160 | |
| Q _C | Total Capacitive Charge | V = 400 V | - | 73 | - | nC |
| C | Total Capacitance | V _R = 1 V, f = 100 kHz | - | 1260 | - | pF |
| | | V _R = 300 V, f = 100 kHz | - | 115 | - | |
| | | V _R = 600 V, f = 100 kHz | - | 104 | - | |

Product parametric performance is indicated in the Electrical Characteristics for the listed test conditions, unless otherwise noted. Product performance may not be indicated by the Electrical Characteristics if operated under different conditions.

PACKAGE MARKING AND ORDERING INFORMATION

| Part Number | Top Marking | Package | Shipping |
|----------------|-------------|--|-----------------|
| FFSH3065B-F085 | FFSH3065B | TO-247-2LD (Pb-Free / Halogen Free) | 30 Units / Tube |

TYPICAL CHARACTERISTICS

($T_J = 25^\circ\text{C}$ unless otherwise noted)

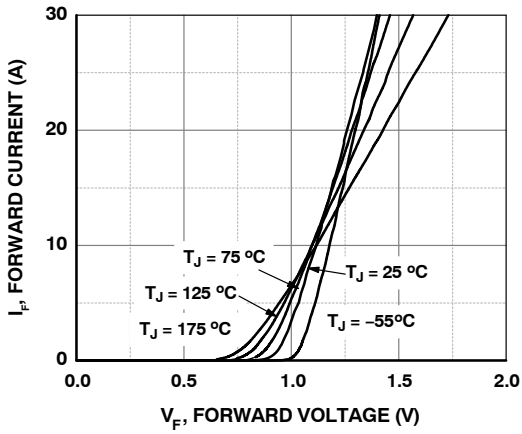

Figure 1. Forward Characteristics

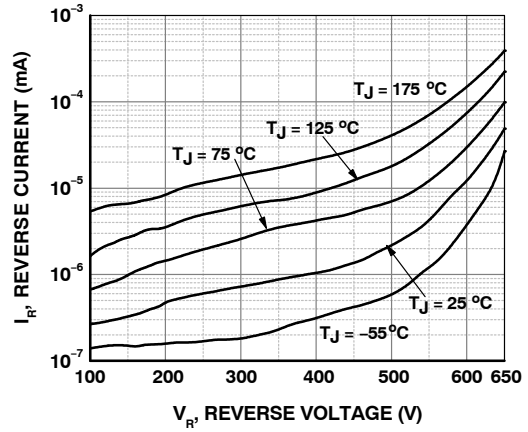

Figure 2. Reverse Characteristics

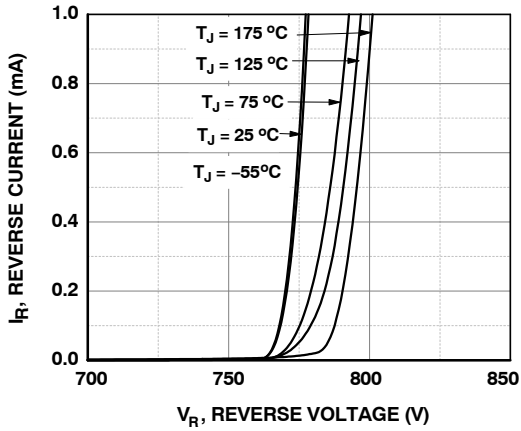

Figure 3. Reverse Characteristics

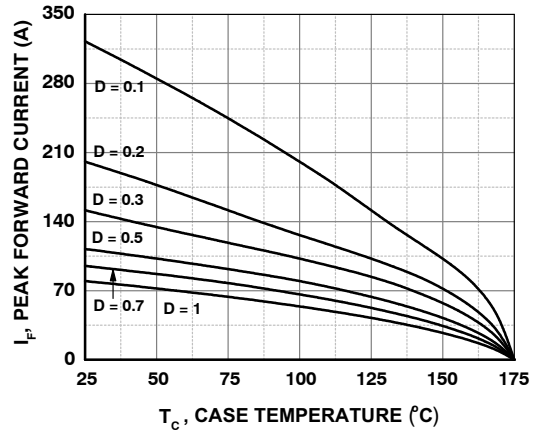

Figure 4. Current Derating

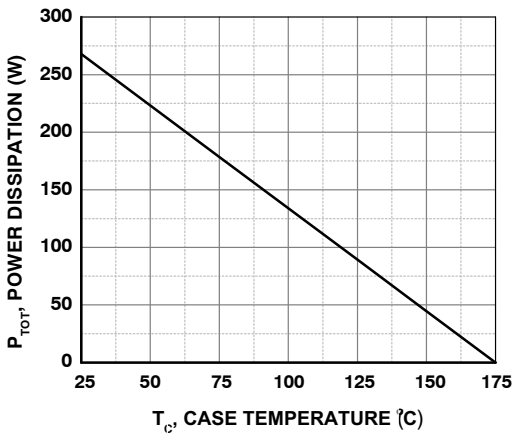

Figure 5. Power Derating

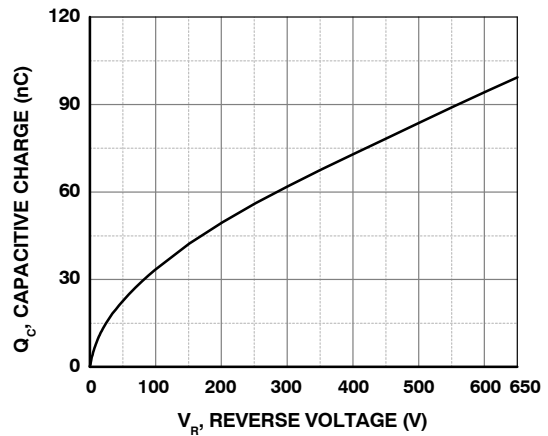

Figure 6. Capacitive Charge vs. Reverse Voltage

TYPICAL CHARACTERISTICS

($T_J = 25^\circ\text{C}$ unless otherwise noted)

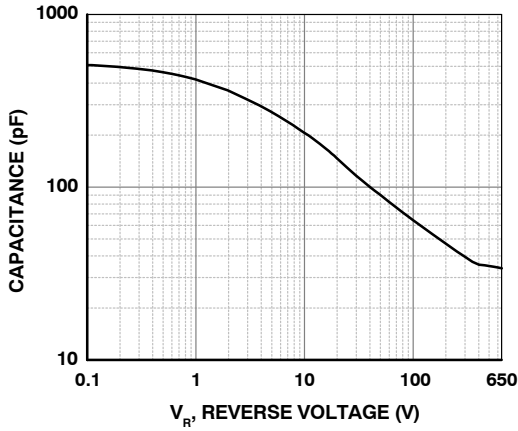

Figure 7. Capacitance vs. Reverse Voltage

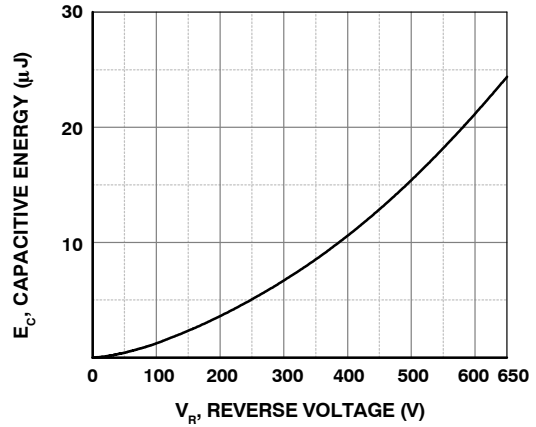

Figure 8. Capacitance Stored Energy

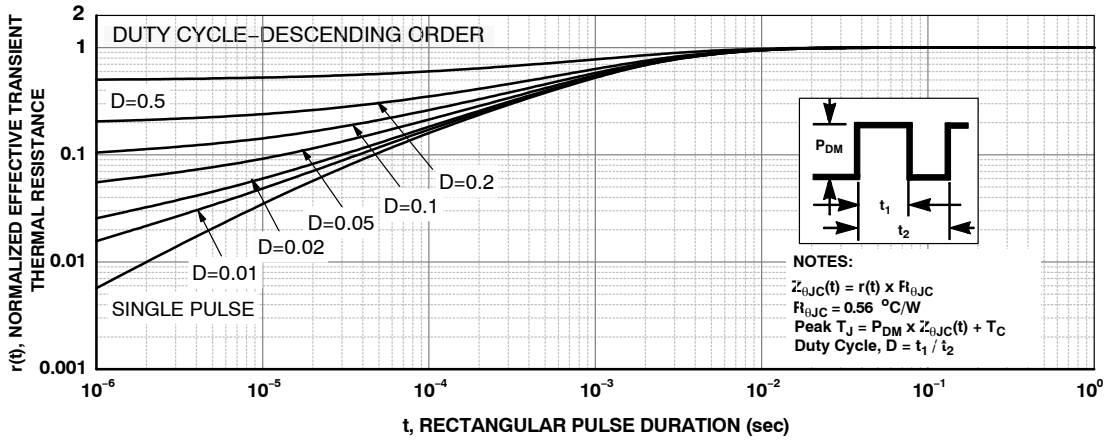

Figure 9. Junction-to-Case Transient Thermal Response Curve

TEST CIRCUIT AND WAVEFORMS

$L = 0.5 \text{ mH}$
 $R < 0.1 \ \Omega$
 $V_{DD} = 50 \text{ V}$
 $E_{AVL} = 1/2LI^2 [V_{R(AVL)} / (V_{R(AVL)} - V_{DD})]$
 $Q1 = \text{IGBT (} BV_{CES} > DUT V_{R(AVL)} \text{)}$

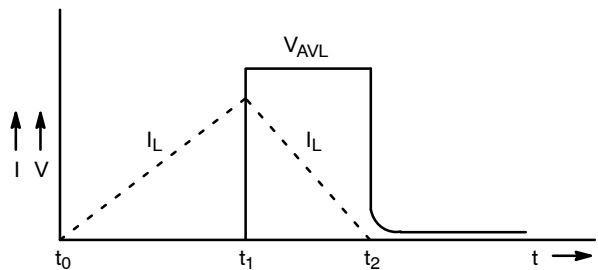
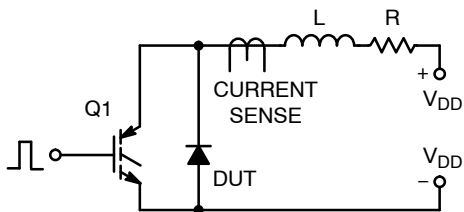
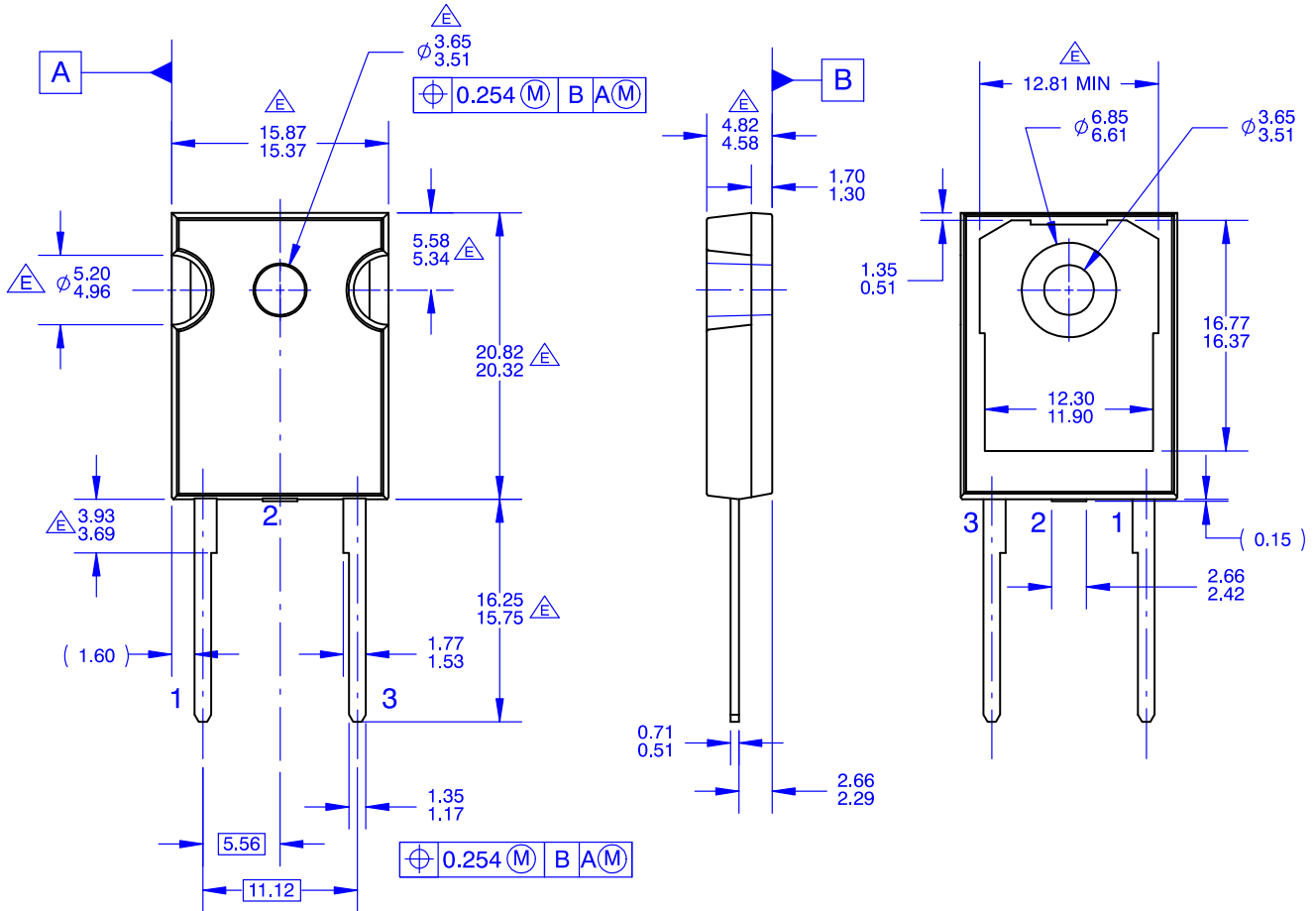

Figure 10. Unclamped Inductive Switching Test Circuit & Waveform

MECHANICAL CASE OUTLINE
PACKAGE DIMENSIONS

TO-247-2LD
CASE 340CL
ISSUE O

DATE 31 OCT 2016



NOTES: UNLESS OTHERWISE SPECIFIED.

- A. PACKAGE REFERENCE: JEDEC TO-247, ISSUE E, VARIATION AB.
- B. DIMENSIONS ARE EXCLUSIVE OF BURRS, MOLD FLASH, AND TIE BAR EXTRUSIONS.
- C. ALL DIMENSIONS ARE IN MILLIMETERS.
- D. DRAWING CONFORMS TO ASME Y14.5 – 2009.

E DOES NOT COMPLY JEDEC STANDARD VALUE.

| | | |
|-------------------------|----------------------------------|--|
| DOCUMENT NUMBER: | 98AON13850G | Electronic versions are uncontrolled except when accessed directly from the Document Repository. Printed versions are uncontrolled except when stamped "CONTROLLED COPY" in red. |
| STATUS: | ON SEMICONDUCTOR STANDARD | |
| NEW STANDARD: | | |
| DESCRIPTION: | TO-247-2LD | PAGE 1 OF 2 |

ON Semiconductor and  are trademarks of Semiconductor Components Industries, LLC dba ON Semiconductor or its subsidiaries in the United States and/or other countries. ON Semiconductor owns the rights to a number of patents, trademarks, copyrights, trade secrets, and other intellectual property. A listing of ON Semiconductor's product/patent coverage may be accessed at www.onsemi.com/site/pdf/Patent-Marking.pdf. ON Semiconductor reserves the right to make changes without further notice to any products herein. ON Semiconductor makes no warranty, representation or guarantee regarding the suitability of its products for any particular purpose, nor does ON Semiconductor assume any liability arising out of the application or use of any product or circuit, and specifically disclaims any and all liability, including without limitation special, consequential or incidental damages. Buyer is responsible for its products and applications using ON Semiconductor products, including compliance with all laws, regulations and safety requirements or standards, regardless of any support or applications information provided by ON Semiconductor. "Typical" parameters which may be provided in ON Semiconductor data sheets and/or specifications can and do vary in different applications and actual performance may vary over time. All operating parameters, including "Typicals" must be validated for each customer application by customer's technical experts. ON Semiconductor does not convey any license under its patent rights nor the rights of others. ON Semiconductor products are not designed, intended, or authorized for use as a critical component in life support systems or any FDA Class 3 medical devices or medical devices with a same or similar classification in a foreign jurisdiction or any devices intended for implantation in the human body. Should Buyer purchase or use ON Semiconductor products for any such unintended or unauthorized application, Buyer shall indemnify and hold ON Semiconductor and its officers, employees, subsidiaries, affiliates, and distributors harmless against all claims, costs, damages, and expenses, and reasonable attorney fees arising out of, directly or indirectly, any claim of personal injury or death associated with such unintended or unauthorized use, even if such claim alleges that ON Semiconductor was negligent regarding the design or manufacture of the part. ON Semiconductor is an Equal Opportunity/Affirmative Action Employer. This literature is subject to all applicable copyright laws and is not for resale in any manner.

PUBLICATION ORDERING INFORMATION

LITERATURE FULFILLMENT:

Literature Distribution Center for ON Semiconductor
19521 E. 32nd Pkwy, Aurora, Colorado 80011 USA
Phone: 303-675-2175 or 800-344-3860 Toll Free USA/Canada
Fax: 303-675-2176 or 800-344-3867 Toll Free USA/Canada
Email: orderlit@onsemi.com

N. American Technical Support: 800-282-9855 Toll Free
USA/Canada
Europe, Middle East and Africa Technical Support:
Phone: 421 33 790 2910

ON Semiconductor Website: www.onsemi.com

Order Literature: <http://www.onsemi.com/orderlit>

For additional information, please contact your local
Sales Representative