



Is Now Part of



**ON Semiconductor®**

To learn more about ON Semiconductor, please visit our website at  
[www.onsemi.com](http://www.onsemi.com)

Please note: As part of the Fairchild Semiconductor integration, some of the Fairchild orderable part numbers will need to change in order to meet ON Semiconductor's system requirements. Since the ON Semiconductor product management systems do not have the ability to manage part nomenclature that utilizes an underscore (\_), the underscore (\_) in the Fairchild part numbers will be changed to a dash (-). This document may contain device numbers with an underscore (\_). Please check the ON Semiconductor website to verify the updated device numbers. The most current and up-to-date ordering information can be found at [www.onsemi.com](http://www.onsemi.com). Please email any questions regarding the system integration to [Fairchild\\_questions@onsemi.com](mailto:Fairchild_questions@onsemi.com).

ON Semiconductor and the ON Semiconductor logo are trademarks of Semiconductor Components Industries, LLC dba ON Semiconductor or its subsidiaries in the United States and/or other countries. ON Semiconductor owns the rights to a number of patents, trademarks, copyrights, trade secrets, and other intellectual property. A listing of ON Semiconductor's product/patent coverage may be accessed at [www.onsemi.com/site/pdf/Patent-Marking.pdf](http://www.onsemi.com/site/pdf/Patent-Marking.pdf). ON Semiconductor reserves the right to make changes without further notice to any products herein. ON Semiconductor makes no warranty, representation or guarantee regarding the suitability of its products for any particular purpose, nor does ON Semiconductor assume any liability arising out of the application or use of any product or circuit, and specifically disclaims any and all liability, including without limitation special, consequential or incidental damages. Buyer is responsible for its products and applications using ON Semiconductor products, including compliance with all laws, regulations and safety requirements or standards, regardless of any support or applications information provided by ON Semiconductor. "Typical" parameters which may be provided in ON Semiconductor data sheets and/or specifications can and do vary in different applications and actual performance may vary over time. All operating parameters, including "Typicals" must be validated for each customer application by customer's technical experts. ON Semiconductor does not convey any license under its patent rights nor the rights of others. ON Semiconductor products are not designed, intended, or authorized for use as a critical component in life support systems or any FDA Class 3 medical devices or medical devices with a same or similar classification in a foreign jurisdiction or any devices intended for implantation in the human body. Should Buyer purchase or use ON Semiconductor products for any such unintended or unauthorized application, Buyer shall indemnify and hold ON Semiconductor and its officers, employees, subsidiaries, affiliates, and distributors harmless against all claims, costs, damages, and expenses, and reasonable attorney fees arising out of, directly or indirectly, any claim of personal injury or death associated with such unintended or unauthorized use, even if such claim alleges that ON Semiconductor was negligent regarding the design or manufacture of the part. ON Semiconductor is an Equal Opportunity/Affirmative Action Employer. This literature is subject to all applicable copyright laws and is not for resale in any manner.

**600V, SMPS Series N-Channel IGBT with Anti-Parallel Hyperfast Diode**

The HGTG30N60A4D is a MOS gated high voltage switching devices combining the best features of MOSFETs and bipolar transistors. This device has the high input impedance of a MOSFET and the low on-state conduction loss of a bipolar transistor. The much lower on-state voltage drop varies only moderately between 25°C and 150°C. The IGBT used is the development type TA49343. The diode used in anti-parallel is the development type TA49373.

This IGBT is ideal for many high voltage switching applications operating at high frequencies where low conduction losses are essential. This device has been optimized for high frequency switch mode power supplies.

Formerly Developmental Type TA49345.

**Ordering Information**

PART NUMBER	PACKAGE	BRAND
HGTG30N60A4D	TO-247	30N60A4D

NOTE: When ordering, use the entire part number.

**Symbol**

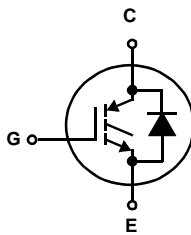

**Features**

- >100kHz Operation At 390V, 30A
- 200kHz Operation At 390V, 18A
- 600V Switching SOA Capability
- Typical Fall Time. . . . . 60ns at T<sub>J</sub> = 125°C
- Low Conduction Loss
- *Temperature Compensating SABER™* Model  
www.fairchildsemi.com

**Packaging**

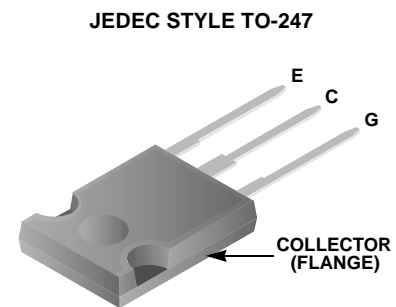

# HGTG30N60A4D

## Absolute Maximum Ratings $T_C = 25^{\circ}\text{C}$ , Unless Otherwise Specified

	HGTG30N60A4D,	UNITS
Collector to Emitter Voltage	600	V
Collector Current Continuous		
At $T_C = 25^{\circ}\text{C}$	75	A
At $T_C = 110^{\circ}\text{C}$	60	A
Collector Current Pulsed (Note 1)	240	A
Gate to Emitter Voltage Continuous	$\pm 20$	V
Gate to Emitter Voltage Pulsed	$\pm 30$	V
Switching Safe Operating Area at $T_J = 150^{\circ}\text{C}$ (Figure 2)	150A at 600V	
Power Dissipation Total at $T_C = 25^{\circ}\text{C}$	463	W
Power Dissipation Derating $T_C > 25^{\circ}\text{C}$	3.7	W/ $^{\circ}\text{C}$
Operating and Storage Junction Temperature Range	-55 to 150	$^{\circ}\text{C}$
Maximum Temperature for Soldering	260	$^{\circ}\text{C}$

CAUTION: Stresses above those listed in "Absolute Maximum Ratings" may cause permanent damage to the device. This is a stress only rating and operation of the device at these or any other conditions above those indicated in the operational sections of this specification is not implied.

### NOTE:

1. Pulse width limited by maximum junction temperature.

## Electrical Specifications $T_J = 25^{\circ}\text{C}$ , Unless Otherwise Specified

PARAMETER	SYMBOL	TEST CONDITIONS	MIN	TYP	MAX	UNITS	
Collector to Emitter Breakdown Voltage	$BV_{CES}$	$I_C = 250\mu\text{A}$ , $V_{GE} = 0\text{V}$	600	-	-	V	
Collector to Emitter Leakage Current	$I_{CES}$	$V_{CE} = 600\text{V}$	$T_J = 25^{\circ}\text{C}$	-	-	250	$\mu\text{A}$
			$T_J = 125^{\circ}\text{C}$	-	-	2.8	mA
Collector to Emitter Saturation Voltage	$V_{CE(SAT)}$	$I_C = 30\text{A}$ , $V_{GE} = 15\text{V}$	$T_J = 25^{\circ}\text{C}$	-	1.8	2.6	V
			$T_J = 125^{\circ}\text{C}$	-	1.6	2.0	V
Gate to Emitter Threshold Voltage	$V_{GE(TH)}$	$I_C = 250\mu\text{A}$ , $V_{CE} = V_{GE}$	4.5	5.2	7.0	V	
Gate to Emitter Leakage Current	$I_{GES}$	$V_{GE} = \pm 20\text{V}$	-	-	$\pm 250$	nA	
Switching SOA	SSOA	$T_J = 150^{\circ}\text{C}$ , $R_G = 3\Omega$ , $V_{GE} = 15\text{V}$ , $L = 100\mu\text{H}$ , $V_{CE} = 600\text{V}$	150	-	-	A	
Gate to Emitter Plateau Voltage	$V_{GEP}$	$I_C = 30\text{A}$ , $V_{CE} = 300\text{V}$	-	8.5	-	V	
On-State Gate Charge	$Q_{g(ON)}$	$I_C = 30\text{A}$ , $V_{CE} = 300\text{V}$	$V_{GE} = 15\text{V}$	-	225	270	nC
			$V_{GE} = 20\text{V}$	-	300	360	nC
Current Turn-On Delay Time	$t_{d(ON)I}$	IGBT and Diode at $T_J = 25^{\circ}\text{C}$ , $I_{CE} = 30\text{A}$ , $V_{CE} = 390\text{V}$ , $V_{GE} = 15\text{V}$ , $R_G = 3\Omega$ , $L = 200\mu\text{H}$ , Test Circuit (Figure 24)	-	25	-	ns	
Current Rise Time	$t_{rI}$		-	12	-	ns	
Current Turn-Off Delay Time	$t_{d(OFF)I}$		-	150	-	ns	
Current Fall Time	$t_{fI}$		-	38	-	ns	
Turn-On Energy (Note 2)	$E_{ON1}$		-	280	-	$\mu\text{J}$	
Turn-On Energy (Note 2)	$E_{ON2}$		-	600	-	$\mu\text{J}$	
Turn-Off Energy (Note 3)	$E_{OFF}$		-	240	350	$\mu\text{J}$	
Current Turn-On Delay Time	$t_{d(ON)I}$	IGBT and Diode at $T_J = 125^{\circ}\text{C}$ , $I_{CE} = 30\text{A}$ , $V_{CE} = 390\text{V}$ , $V_{GE} = 15\text{V}$ , $R_G = 3\Omega$ , $L = 200\mu\text{H}$ , Test Circuit (Figure 24)	-	24	-	ns	
Current Rise Time	$t_{rI}$		-	11	-	ns	
Current Turn-Off Delay Time	$t_{d(OFF)I}$		-	180	200	ns	
Current Fall Time	$t_{fI}$		-	58	70	ns	
Turn-On Energy (Note 2)	$E_{ON1}$		-	280	-	$\mu\text{J}$	
Turn-On Energy (Note 2)	$E_{ON2}$		-	1000	1200	$\mu\text{J}$	
Turn-Off Energy (Note 3)	$E_{OFF}$		-	450	750	$\mu\text{J}$	
Diode Forward Voltage	$V_{EC}$	$I_{EC} = 30\text{A}$	-	2.2	2.5	V	
Diode Reverse Recovery Time	$t_{rr}$	$I_{EC} = 30\text{A}$ , $dI_{EC}/dt = 200\text{A}/\mu\text{s}$	-	40	55	ns	
		$I_{EC} = 1\text{A}$ , $dI_{EC}/dt = 200\text{A}/\mu\text{s}$	-	30	42	ns	

# HGTG30N60A4D

## Electrical Specifications $T_J = 25^\circ\text{C}$ , Unless Otherwise Specified (Continued)

PARAMETER	SYMBOL	TEST CONDITIONS	MIN	TYP	MAX	UNITS
Thermal Resistance Junction To Case	$R_{\theta JC}$	IGBT	-	-	0.27	$^\circ\text{C/W}$
		Diode	-	-	0.65	$^\circ\text{C/W}$

### NOTES:

- Values for two Turn-On loss conditions are shown for the convenience of the circuit designer.  $E_{ON1}$  is the turn-on loss of the IGBT only.  $E_{ON2}$  is the turn-on loss when a typical diode is used in the test circuit and the diode is at the same  $T_J$  as the IGBT. The diode type is specified in Figure 24.
- Turn-Off Energy Loss ( $E_{OFF}$ ) is defined as the integral of the instantaneous power loss starting at the trailing edge of the input pulse and ending at the point where the collector current equals zero ( $I_{CE} = 0\text{A}$ ). All devices were tested per JEDEC Standard No. 24-1 Method for Measurement of Power Device Turn-Off Switching Loss. This test method produces the true total Turn-Off Energy Loss.

## Typical Performance Curves Unless Otherwise Specified

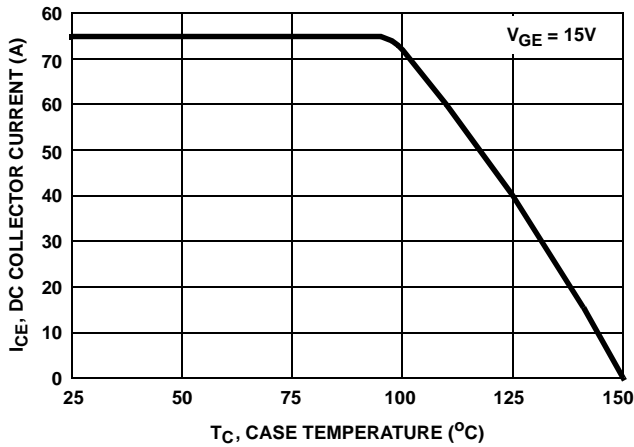

FIGURE 1. DC COLLECTOR CURRENT vs CASE TEMPERATURE

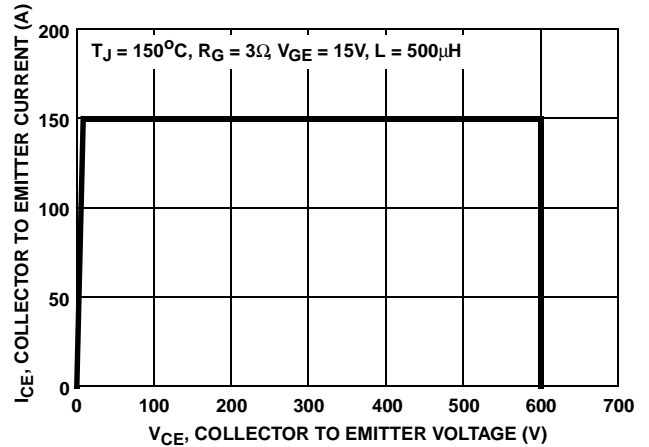

FIGURE 2. MINIMUM SWITCHING SAFE OPERATING AREA

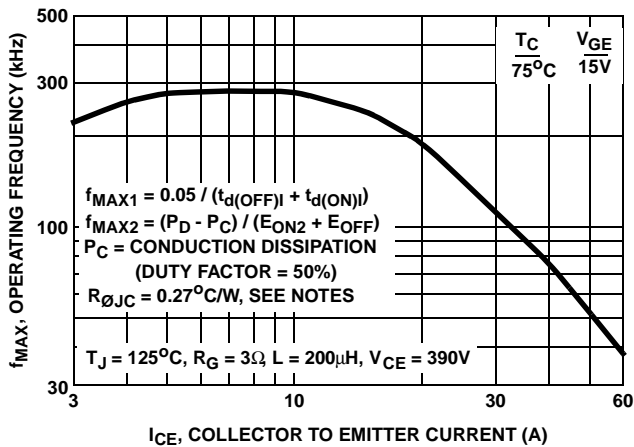

FIGURE 3. OPERATING FREQUENCY vs COLLECTOR TO EMITTER CURRENT

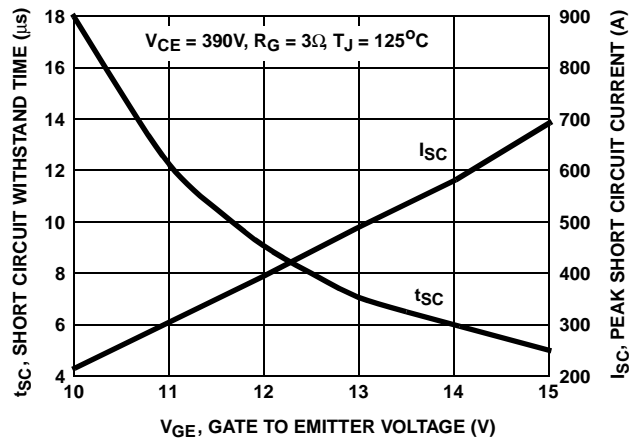

FIGURE 4. SHORT CIRCUIT WITHSTAND TIME

Typical Performance Curves Unless Otherwise Specified (Continued)

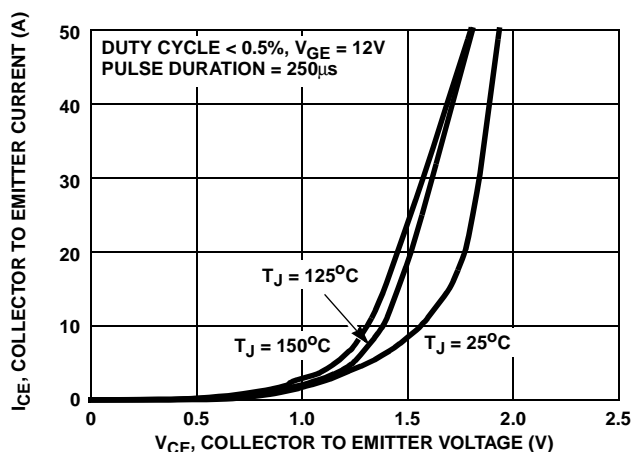

FIGURE 5. COLLECTOR TO EMITTER ON-STATE VOLTAGE

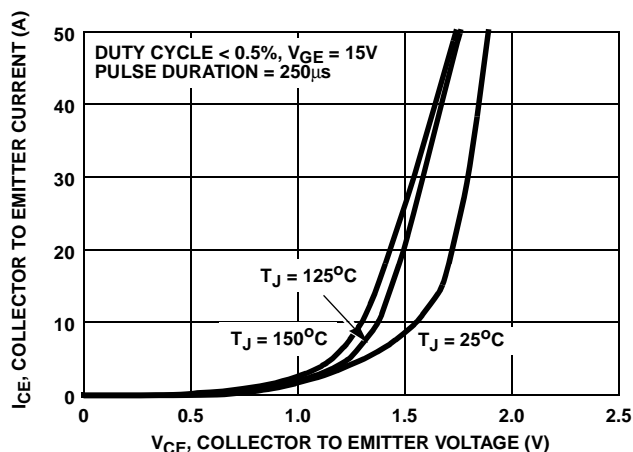

FIGURE 6. COLLECTOR TO EMITTER ON-STATE VOLTAGE

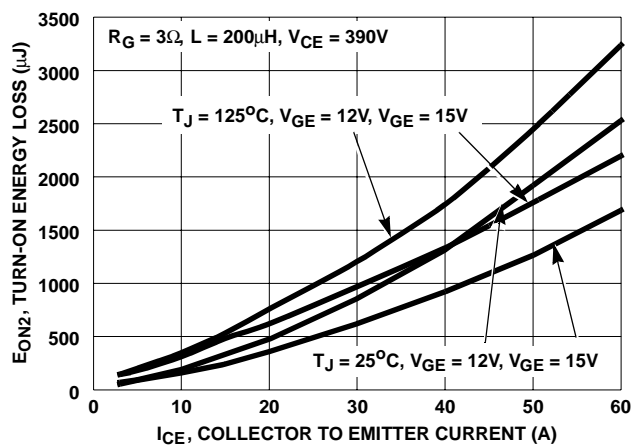

FIGURE 7. TURN-ON ENERGY LOSS vs COLLECTOR TO EMITTER CURRENT

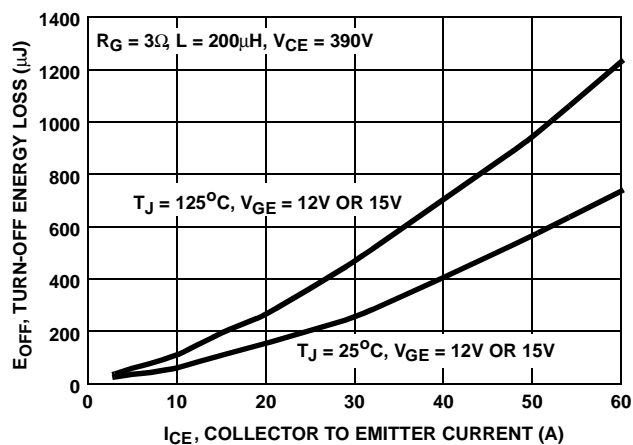

FIGURE 8. TURN-OFF ENERGY LOSS vs COLLECTOR TO EMITTER CURRENT

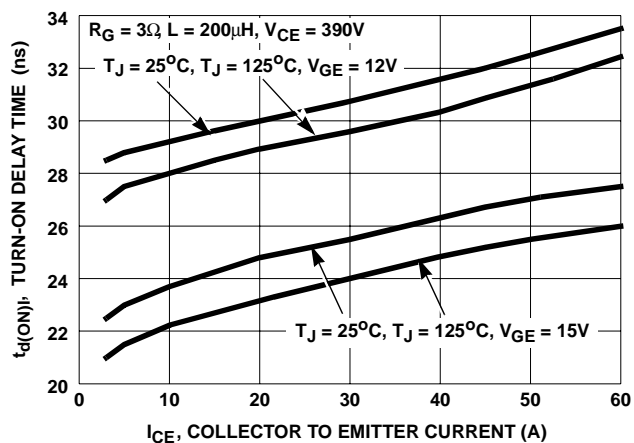

FIGURE 9. TURN-ON DELAY TIME vs COLLECTOR TO EMITTER CURRENT

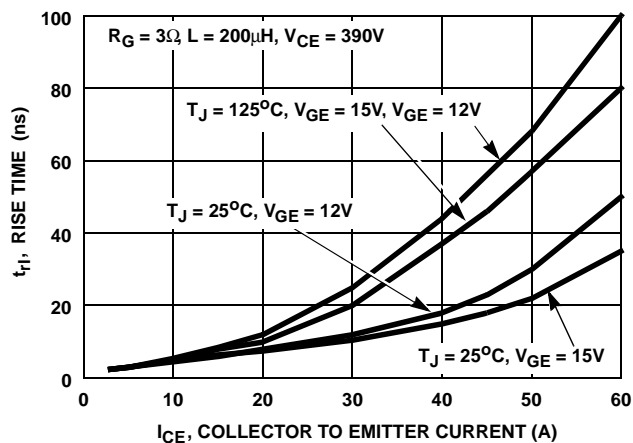

FIGURE 10. TURN-ON RISE TIME vs COLLECTOR TO EMITTER CURRENT

Typical Performance Curves Unless Otherwise Specified (Continued)

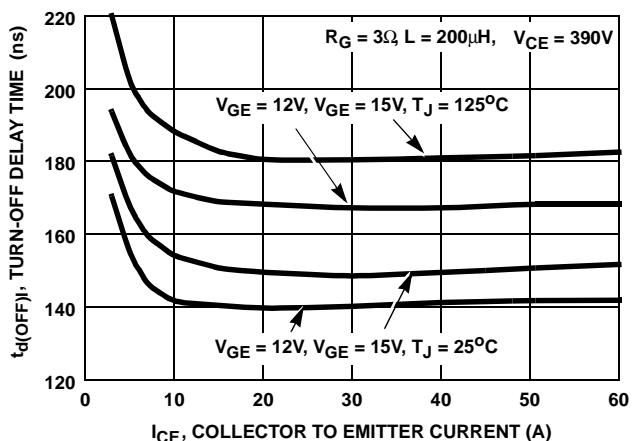

FIGURE 11. TURN-OFF DELAY TIME vs COLLECTOR TO EMITTER CURRENT

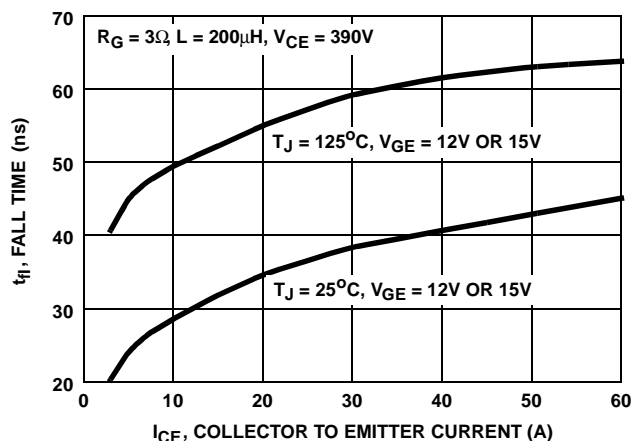

FIGURE 12. FALL TIME vs COLLECTOR TO EMITTER CURRENT

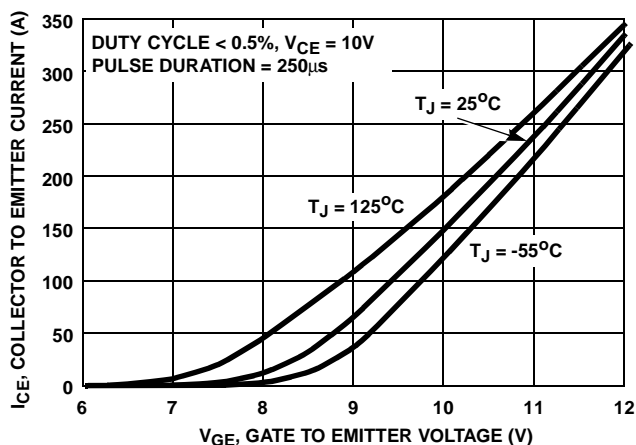

FIGURE 13. TRANSFER CHARACTERISTIC

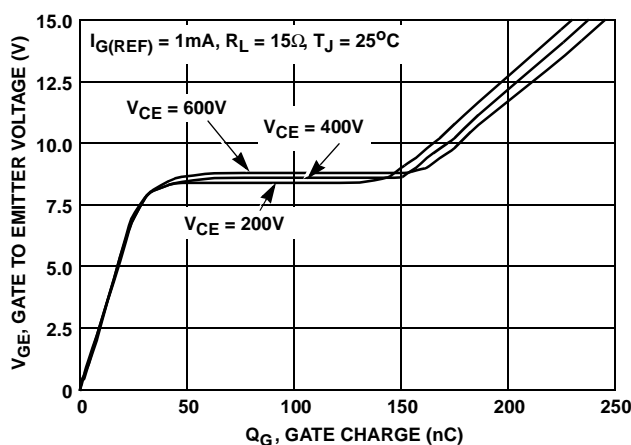

FIGURE 14. GATE CHARGE WAVEFORMS

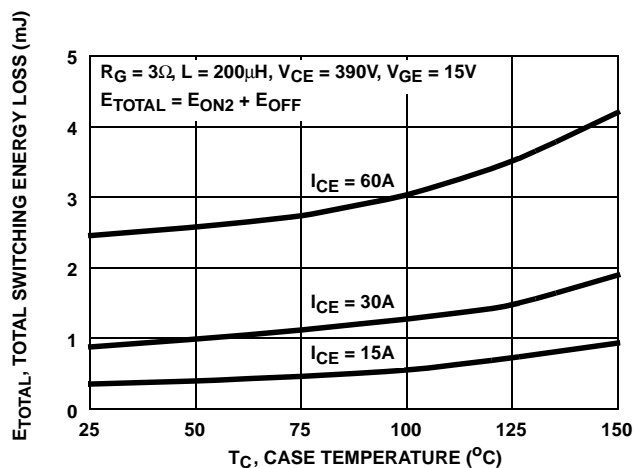

FIGURE 15. TOTAL SWITCHING LOSS vs CASE TEMPERATURE

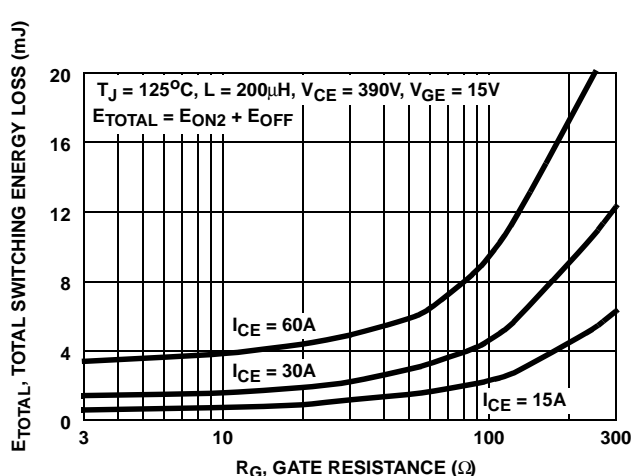

FIGURE 16. TOTAL SWITCHING LOSS vs GATE RESISTANCE

Typical Performance Curves Unless Otherwise Specified (Continued)

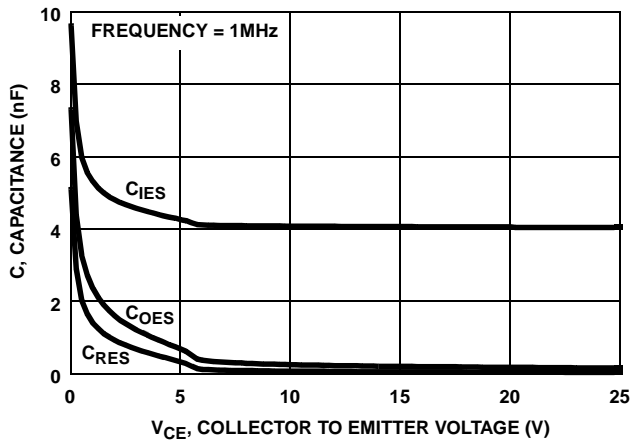

FIGURE 17. CAPACITANCE vs COLLECTOR TO EMITTER VOLTAGE

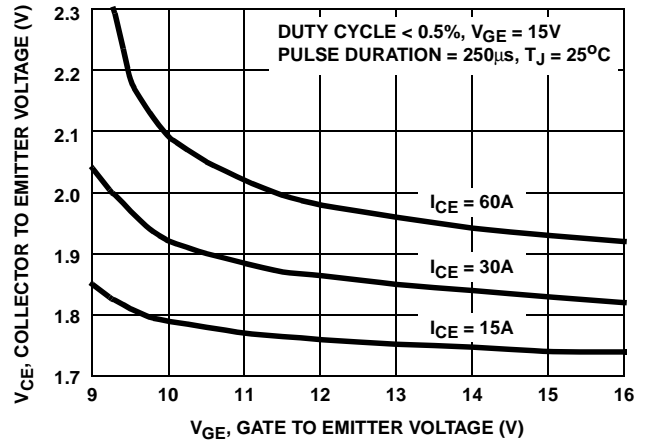

FIGURE 18. COLLECTOR TO EMITTER ON-STATE VOLTAGE vs GATE TO EMITTER VOLTAGE

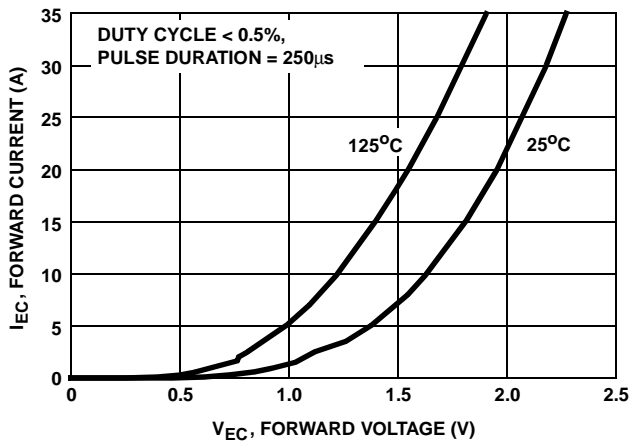

FIGURE 19. DIODE FORWARD CURRENT vs FORWARD VOLTAGE DROP

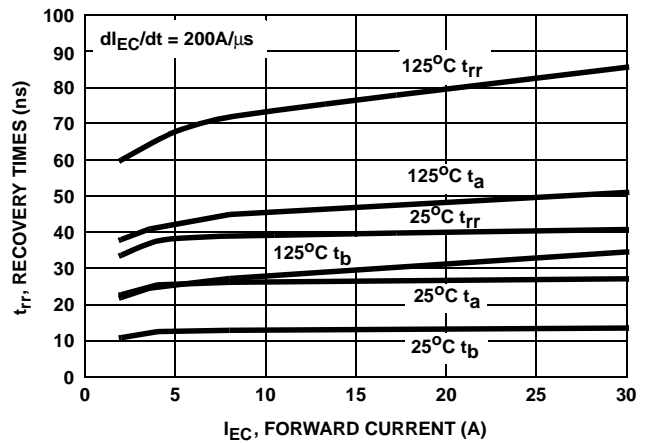

FIGURE 20. RECOVERY TIMES vs FORWARD CURRENT

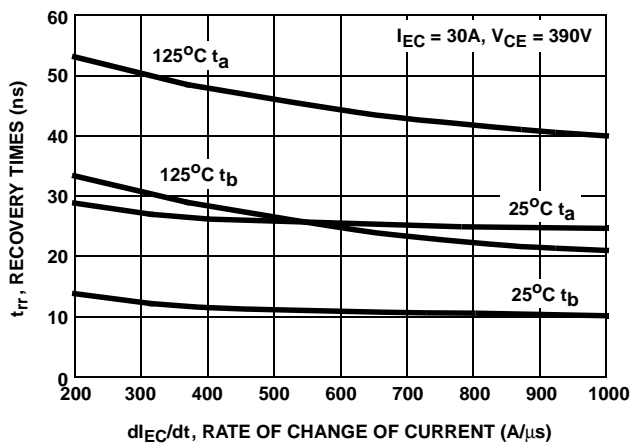

FIGURE 21. RECOVERY TIMES vs RATE OF CHANGE OF CURRENT

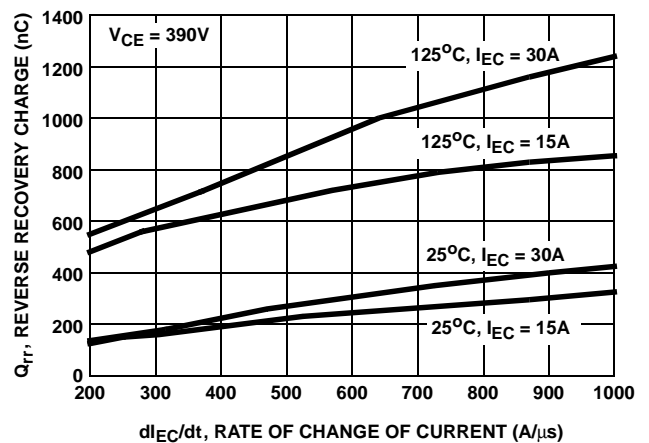

FIGURE 22. STORED CHARGE vs RATE OF CHANGE OF CURRENT

Typical Performance Curves Unless Otherwise Specified (Continued)

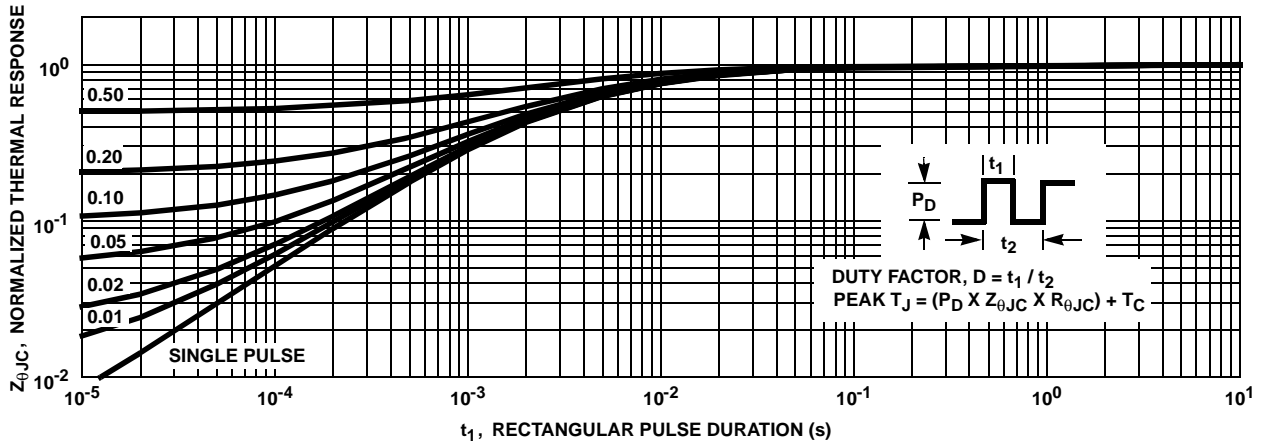

FIGURE 23. IGBT NORMALIZED TRANSIENT THERMAL RESPONSE, JUNCTION TO CASE

Test Circuit and Waveforms

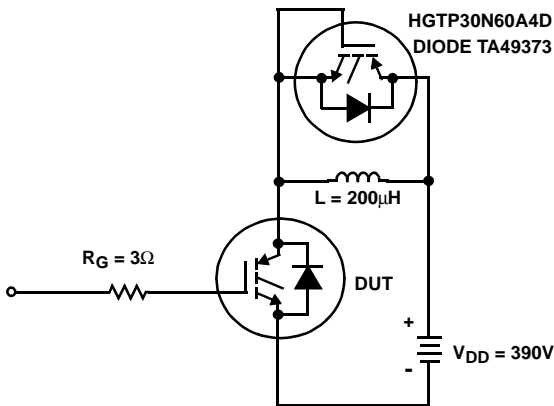

FIGURE 24. INDUCTIVE SWITCHING TEST CIRCUIT

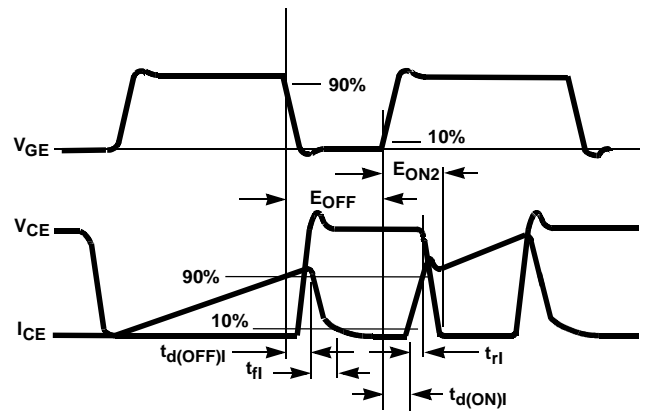

FIGURE 25. SWITCHING TEST WAVEFORMS



## Handling Precautions for IGBTs

Insulated Gate Bipolar Transistors are susceptible to gate-insulation damage by the electrostatic discharge of energy through the devices. When handling these devices, care should be exercised to assure that the static charge built in the handler's body capacitance is not discharged through the device. With proper handling and application procedures, however, IGBTs are currently being extensively used in production by numerous equipment manufacturers in military, industrial and consumer applications, with virtually no damage problems due to electrostatic discharge. IGBTs can be handled safely if the following basic precautions are taken:

1. Prior to assembly into a circuit, all leads should be kept shorted together either by the use of metal shorting springs or by the insertion into conductive material such as "ECCOSORB<sup>TM</sup> LD26" or equivalent.
2. When devices are removed by hand from their carriers, the hand being used should be grounded by any suitable means - for example, with a metallic wristband.
3. Tips of soldering irons should be grounded.
4. Devices should never be inserted into or removed from circuits with power on.
5. **Gate Voltage Rating** - Never exceed the gate-voltage rating of  $V_{GEM}$ . Exceeding the rated  $V_{GE}$  can result in permanent damage to the oxide layer in the gate region.
6. **Gate Termination** - The gates of these devices are essentially capacitors. Circuits that leave the gate open-circuited or floating should be avoided. These conditions can result in turn-on of the device due to voltage buildup on the input capacitor due to leakage currents or pickup.
7. **Gate Protection** - These devices do not have an internal monolithic Zener diode from gate to emitter. If gate protection is required an external Zener is recommended.

## Operating Frequency Information

Operating frequency information for a typical device (Figure 3) is presented as a guide for estimating device performance for a specific application. Other typical frequency vs collector current ( $I_{CE}$ ) plots are possible using the information shown for a typical unit in Figures 5, 6, 7, 8, 9 and 11. The operating frequency plot (Figure 3) of a typical device shows  $f_{MAX1}$  or  $f_{MAX2}$ ; whichever is smaller at each point. The information is based on measurements of a typical device and is bounded by the maximum rated junction temperature.

$f_{MAX1}$  is defined by  $f_{MAX1} = 0.05 / (t_{d(OFF)I} + t_{d(ON)I})$ . Deadtime (the denominator) has been arbitrarily held to 10% of the on-state time for a 50% duty factor. Other definitions are possible.  $t_{d(OFF)I}$  and  $t_{d(ON)I}$  are defined in Figure 25. Device turn-off delay can establish an additional frequency limiting condition for an application other than  $T_{JM}$ .  $t_{d(OFF)I}$  is important when controlling output ripple under a lightly loaded condition.

$f_{MAX2}$  is defined by  $f_{MAX2} = (P_D - P_C) / (E_{OFF} + E_{ON2})$ . The allowable dissipation ( $P_D$ ) is defined by  $P_D = (T_{JM} - T_C) / R_{\theta JC}$ . The sum of device switching and conduction losses must not exceed  $P_D$ . A 50% duty factor was used (Figure 3) and the conduction losses ( $P_C$ ) are approximated by  $P_C = (V_{CE} \times I_{CE}) / 2$ .

$E_{ON2}$  and  $E_{OFF}$  are defined in the switching waveforms shown in Figure 25.  $E_{ON2}$  is the integral of the instantaneous power loss ( $I_{CE} \times V_{CE}$ ) during turn-on and  $E_{OFF}$  is the integral of the instantaneous power loss ( $I_{CE} \times V_{CE}$ ) during turn-off. All tail losses are included in the calculation for  $E_{OFF}$ ; i.e., the collector current equals zero ( $I_{CE} = 0$ ).

## TRADEMARKS

The following are registered and unregistered trademarks Fairchild Semiconductor owns or is authorized to use and is not intended to be an exhaustive list of all such trademarks.

ACEx™	FAST®	ISOPLANAR™	Power247™	SuperFET™
ActiveArray™	FASTr™	LittleFET™	PowerSaver™	SuperSOT™-3
Bottomless™	FPST™	MICROCOUPLER™	PowerTrench®	SuperSOT™-6
CoolFET™	FRFET™	MicroFET™	QFET®	SuperSOT™-8
CROSSVOLT™	GlobalOptoisolator™	MicroPak™	QS™	SyncFET™
DOMET™	GTO™	MICROWIRE™	QT Optoelectronics™	TinyLogic®
EcoSPARK™	HiSeC™	MSX™	Quiet Series™	TINYOPTO™
E <sup>2</sup> C MOS™	ꝑC™	MSXPro™	RapidConfigure™	TruTranslation™
EnSigna™	i-Lo™	OCX™	RapidConnect™	UHC™
FACT™	ImpliedDisconnect™	OCXPro™	µSerDes™	UltraFET®
FACT Quiet Series™		OPTOLOGIC®	SILENT SWITCHER®	VCX™
Across the board. Around the world.™		OPTOPLANAR™	SMART START™	
The Power Franchise®		PACMAN™	SPM™	
Programmable Active Droop™		POP™	Stealth™	

## DISCLAIMER

FAIRCHILD SEMICONDUCTOR RESERVES THE RIGHT TO MAKE CHANGES WITHOUT FURTHER NOTICE TO ANY PRODUCTS HEREIN TO IMPROVE RELIABILITY, FUNCTION OR DESIGN. FAIRCHILD DOES NOT ASSUME ANY LIABILITY ARISING OUT OF THE APPLICATION OR USE OF ANY PRODUCT OR CIRCUIT DESCRIBED HEREIN; NEITHER DOES IT CONVEY ANY LICENSE UNDER ITS PATENT RIGHTS, NOR THE RIGHTS OF OTHERS.

## LIFE SUPPORT POLICY

FAIRCHILD'S PRODUCTS ARE NOT AUTHORIZED FOR USE AS CRITICAL COMPONENTS IN LIFE SUPPORT DEVICES OR SYSTEMS WITHOUT THE EXPRESS WRITTEN APPROVAL OF FAIRCHILD SEMICONDUCTOR CORPORATION. As used herein:

1. Life support devices or systems are devices or systems which, (a) are intended for surgical implant into the body, or (b) support or sustain life, or (c) whose failure to perform when properly used in accordance with instructions for use provided in the labeling, can be reasonably expected to result in significant injury to the user.
2. A critical component is any component of a life support device or system whose failure to perform can be reasonably expected to cause the failure of the life support device or system, or to affect its safety or effectiveness.

## PRODUCT STATUS DEFINITIONS

### Definition of Terms

Datasheet Identification	Product Status	Definition
Advance Information	Formative or In Design	This datasheet contains the design specifications for product development. Specifications may change in any manner without notice.
Preliminary	First Production	This datasheet contains preliminary data, and supplementary data will be published at a later date. Fairchild Semiconductor reserves the right to make changes at any time without notice in order to improve design.
No Identification Needed	Full Production	This datasheet contains final specifications. Fairchild Semiconductor reserves the right to make changes at any time without notice in order to improve design.
Obsolete	Not In Production	This datasheet contains specifications on a product that has been discontinued by Fairchild semiconductor. The datasheet is printed for reference information only.

ON Semiconductor and  are trademarks of Semiconductor Components Industries, LLC dba ON Semiconductor or its subsidiaries in the United States and/or other countries. ON Semiconductor owns the rights to a number of patents, trademarks, copyrights, trade secrets, and other intellectual property. A listing of ON Semiconductor's product/patent coverage may be accessed at [www.onsemi.com/site/pdf/Patent-Marking.pdf](http://www.onsemi.com/site/pdf/Patent-Marking.pdf). ON Semiconductor reserves the right to make changes without further notice to any products herein. ON Semiconductor makes no warranty, representation or guarantee regarding the suitability of its products for any particular purpose, nor does ON Semiconductor assume any liability arising out of the application or use of any product or circuit, and specifically disclaims any and all liability, including without limitation special, consequential or incidental damages. Buyer is responsible for its products and applications using ON Semiconductor products, including compliance with all laws, regulations and safety requirements or standards, regardless of any support or applications information provided by ON Semiconductor. "Typical" parameters which may be provided in ON Semiconductor data sheets and/or specifications can and do vary in different applications and actual performance may vary over time. All operating parameters, including "Typicals" must be validated for each customer application by customer's technical experts. ON Semiconductor does not convey any license under its patent rights nor the rights of others. ON Semiconductor products are not designed, intended, or authorized for use as a critical component in life support systems or any FDA Class 3 medical devices or medical devices with a same or similar classification in a foreign jurisdiction or any devices intended for implantation in the human body. Should Buyer purchase or use ON Semiconductor products for any such unintended or unauthorized application, Buyer shall indemnify and hold ON Semiconductor and its officers, employees, subsidiaries, affiliates, and distributors harmless against all claims, costs, damages, and expenses, and reasonable attorney fees arising out of, directly or indirectly, any claim of personal injury or death associated with such unintended or unauthorized use, even if such claim alleges that ON Semiconductor was negligent regarding the design or manufacture of the part. ON Semiconductor is an Equal Opportunity/Affirmative Action Employer. This literature is subject to all applicable copyright laws and is not for resale in any manner.

## PUBLICATION ORDERING INFORMATION

### LITERATURE FULFILLMENT:

Literature Distribution Center for ON Semiconductor  
19521 E. 32nd Pkwy, Aurora, Colorado 80011 USA  
**Phone:** 303-675-2175 or 800-344-3860 Toll Free USA/Canada  
**Fax:** 303-675-2176 or 800-344-3867 Toll Free USA/Canada  
**Email:** [orderlit@onsemi.com](mailto:orderlit@onsemi.com)

**N. American Technical Support:** 800-282-9855 Toll Free  
USA/Canada  
**Europe, Middle East and Africa Technical Support:**  
Phone: 421 33 790 2910  
**Japan Customer Focus Center**  
Phone: 81-3-5817-1050

**ON Semiconductor Website:** [www.onsemi.com](http://www.onsemi.com)  
**Order Literature:** <http://www.onsemi.com/orderlit>  
For additional information, please contact your local  
Sales Representative