

MCR225-8FP, MCR225-10FP

Preferred Device

Silicon Controlled Rectifiers

Reverse Blocking Thyristors

Designed primarily for half-wave ac control applications, such as motor controls, heating controls and power supply crowbar circuits.

- Glass Passivated Junctions with Center Gate Fire for Greater Parameter Uniformity and Stability
- Small, Rugged, Thermowatt Constructed for Low Thermal Resistance, High Heat Dissipation and Durability
- Blocking Voltage to 800 Volts
- 300 A Surge Current Capability
- Insulated Package Simplifies Mounting
-  Indicates UL Registered — File #E69369
- Device Marking: Logo, Device Type, e.g., MCR225-8FP, Date Code

MAXIMUM RATINGS ($T_J = 25^\circ\text{C}$ unless otherwise noted)

Rating	Symbol	Value	Unit
Peak Repetitive Off-State Voltage ⁽¹⁾ ($T_J = -40$ to $+125^\circ\text{C}$, Sine Wave, 50 to 60 Hz, Gate Open) MCR225-8FP MCR225-10FP	V_{DRM} , V_{RRM}	600 800	Volts
On-State RMS Current ($T_C = +70^\circ\text{C}$) (180° Conduction Angles)	$I_T(\text{RMS})$	25	Amps
Peak Non-repetitive Surge Current (1/2 Cycle, Sine Wave 60 Hz, $T_C = +70^\circ\text{C}$)	I_{TSM}	300	Amps
Circuit Fusing ($t = 8.3$ ms)	I^2t	375	A^2s
Forward Peak Gate Power ($T_C = +70^\circ\text{C}$, Pulse Width ≤ 1.0 μs)	P_{GM}	20	Watts
Forward Average Gate Power ($T_C = +70^\circ\text{C}$, $t = 8.3$ ms)	$P_{G(AV)}$	0.5	Watt
Forward Peak Gate Current ($T_C = +70^\circ\text{C}$, Pulse Width ≤ 1.0 μs)	I_{GM}	2.0	Amps
RMS Isolation Voltage ($T_A = 25^\circ\text{C}$, Relative Humidity $\leq 20\%$) 	$V_{(ISO)}$	1500	Volts
Operating Junction Temperature Range	T_J	-40 to $+125$	$^\circ\text{C}$
Storage Temperature Range	T_{stg}	-40 to $+150$	$^\circ\text{C}$

(1) V_{DRM} and V_{RRM} for all types can be applied on a continuous basis. Ratings apply for zero or negative gate voltage; however, positive gate voltage shall not be applied concurrent with negative potential on the anode. Blocking voltages shall not be tested with a constant current source such that the voltage ratings of the devices are exceeded.



ON Semiconductor

<http://onsemi.com>

ISOLATED SCRs ()
25 AMPERES RMS
600 thru 800 VOLTS

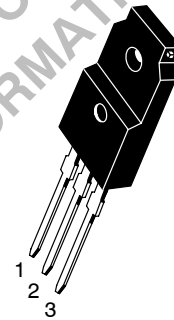

ISOLATED TO-220 Full Pack
CASE 221C
STYLE 2

PIN ASSIGNMENT	
1	Cathode
2	Anode
3	Gate

ORDERING INFORMATION

Device	Package	Shipping
MCR225-8FP	ISOLATED TO220FP	500/Box
MCR225-10FP	ISOLATED TO220FP	500/Box

Preferred devices are recommended choices for future use and best overall value.

MCR225-8FP, MCR225-10FP

THERMAL CHARACTERISTICS

Characteristic	Symbol	Max	Unit
Thermal Resistance, Junction to Case	$R_{\theta JC}$	1.5	$^{\circ}C/W$
Thermal Resistance, Case to Sink	$R_{\theta CS}$	2.2 (typ)	$^{\circ}C/W$
Thermal Resistance, Junction to Ambient	$R_{\theta JA}$	60	$^{\circ}C/W$
Maximum Lead Temperature for Soldering Purposes 1/8" from Case for 10 Seconds	T_L	260	$^{\circ}C$

ELECTRICAL CHARACTERISTICS ($T_C = 25^{\circ}C$ unless otherwise noted.)

Characteristic	Symbol	Min	Typ	Max	Unit
----------------	--------	-----	-----	-----	------

OFF CHARACTERISTICS

Peak Repetitive Forward or Reverse Blocking Current ($V_D = \text{Rated } V_{DRM}, V_{RRM}, \text{ Gate Open}$)	I_{DRM}, I_{RRM}	—	—	10	μA
$T_J = 25^{\circ}C$		—	—	2	mA
$T_J = 125^{\circ}C$		—	—	—	—

ON CHARACTERISTICS

Peak Forward On-State Voltage ⁽¹⁾ ($I_{TM} = 50 A$)	V_{TM}	—	—	1.8	Volts
Gate Trigger Current (Continuous dc) ($V_{AK} = 12 V_{dc}, R_L = 100 \text{ Ohms}$)	I_{GT}	—	—	40	mA
Gate Trigger Voltage (Continuous dc) ($V_{AK} = 12 V_{dc}, R_L = 100 \text{ Ohms}$)	V_{GT}	—	0.8	1.5	Volts
Gate Non-Trigger Voltage ($V_{AK} = 12 V_{dc}, R_L = 100 \text{ Ohms}, T_J = 125^{\circ}C$)	V_{GD}	0.2	—	—	Volts
Holding Current ($V_{AK} = 12 V_{dc}, \text{ Initiating Current} = 200 \text{ mA}, \text{ Gate Open}$)	I_H	—	20	40	mA
Turn-On Time ($I_{TM} = 25 A, I_{GT} = 40 \text{ mAdc}$)	t_{gt}	—	1.5	—	μs
Turn-Off Time ($V_{DRM} = \text{Rated Voltage}$) ($I_{TM} = 25 A, I_R = 25 A$) ($I_{TM} = 25 A, I_R = 25 A, T_J = 125^{\circ}C$)	t_q	—	15	—	μs
		—	35	—	

DYNAMIC CHARACTERISTICS

Critical Rate-of-Rise of Off-State Voltage (Gate Open, $V_D = \text{Rated } V_{DRM}, \text{ Exponential Waveform}$)	dv/dt	—	100	—	$V/\mu s$
---	---------	---	-----	---	-----------

(1) Pulse Test: Pulse Width = 1.0 ms, Duty Cycle \leq 2%.

MCR225-8FP, MCR225-10FP

Voltage Current Characteristic of SCR

Symbol	Parameter
V_{DRM}	Peak Repetitive Off State Forward Voltage
I_{DRM}	Peak Forward Blocking Current
V_{RRM}	Peak Repetitive Off State Reverse Voltage
I_{RRM}	Peak Reverse Blocking Current
V_{TM}	Peak on State Voltage
I_H	Holding Current

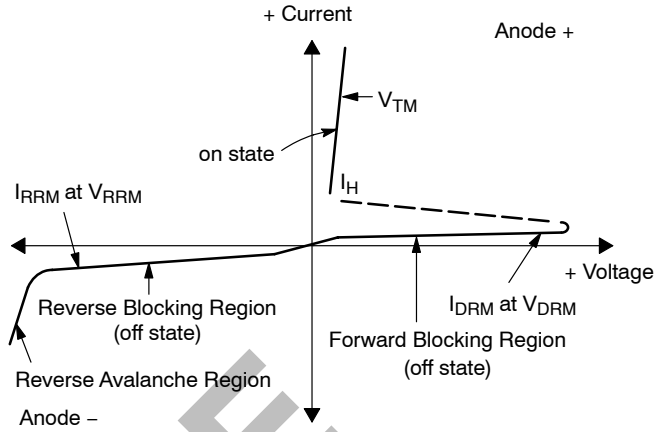

TYPICAL CHARACTERISTICS

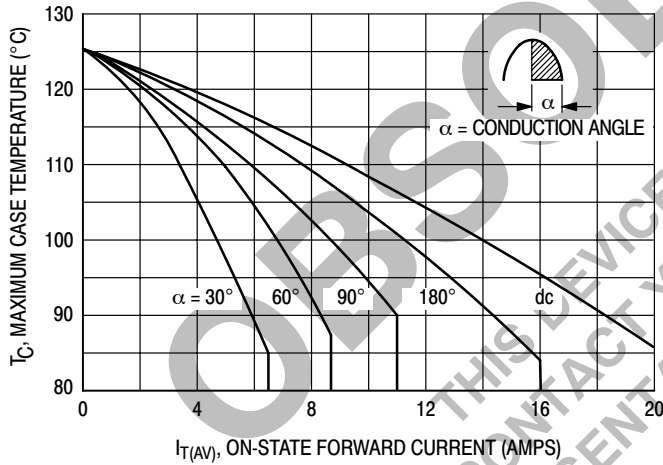

Figure 1. Average Current Derating

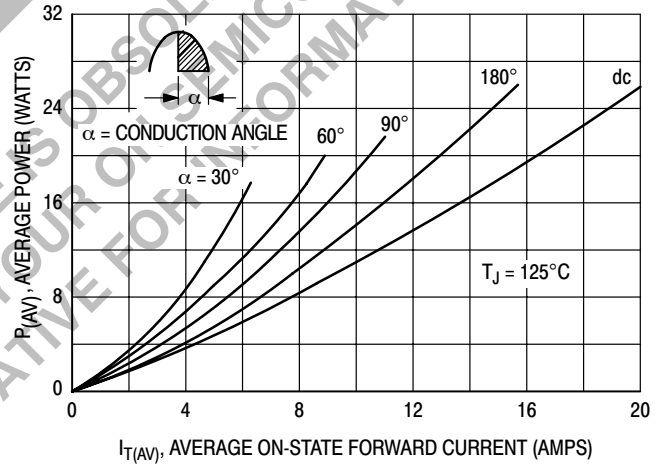

Figure 2. Maximum On-State Power Dissipation

MCR225-8FP, MCR225-10FP

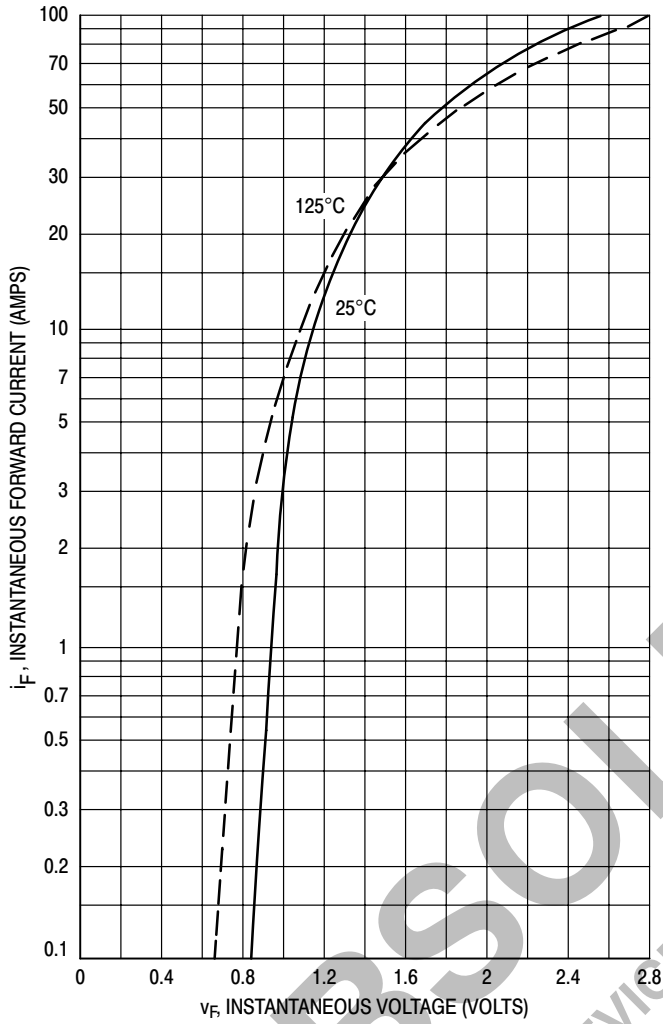

Figure 3. Maximum Forward Voltage

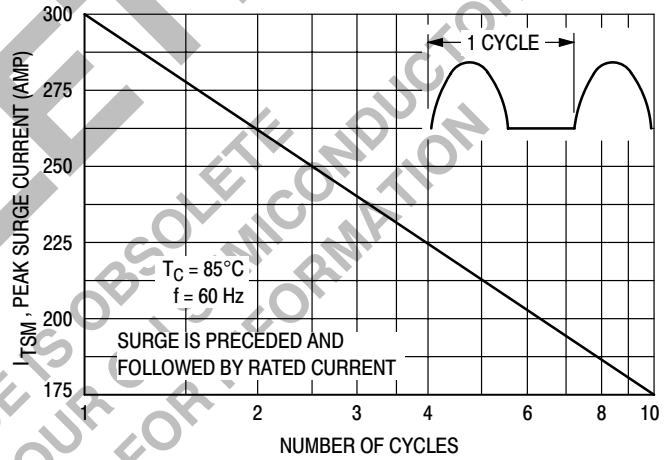

Figure 4. Maximum Non-Repetitive Surge Current

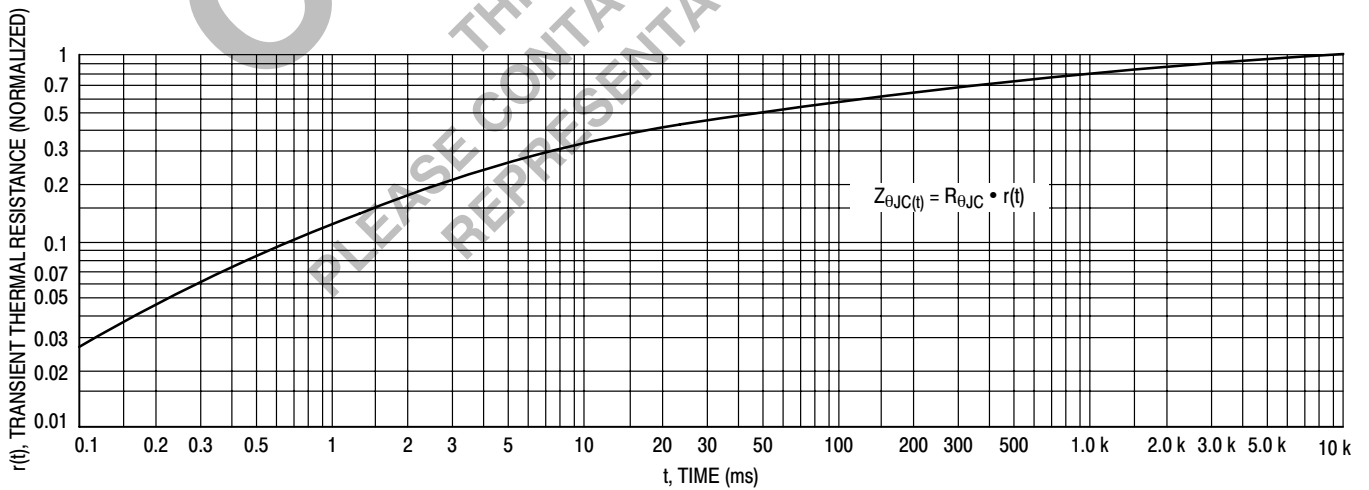

Figure 5. Thermal Response

MCR225-8FP, MCR225-10FP

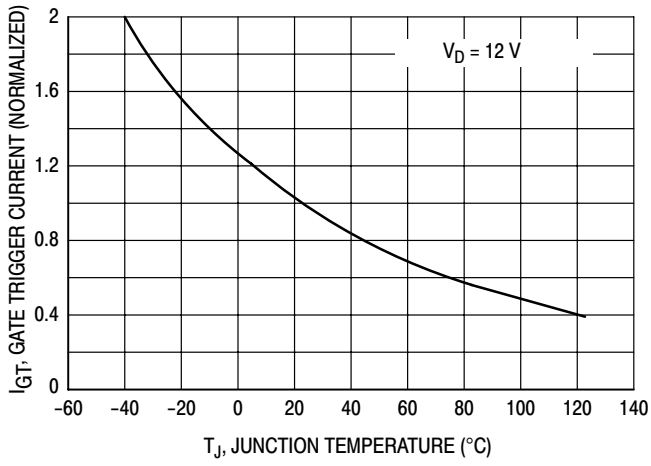

Figure 6. Typical Gate Trigger Current versus Temperature

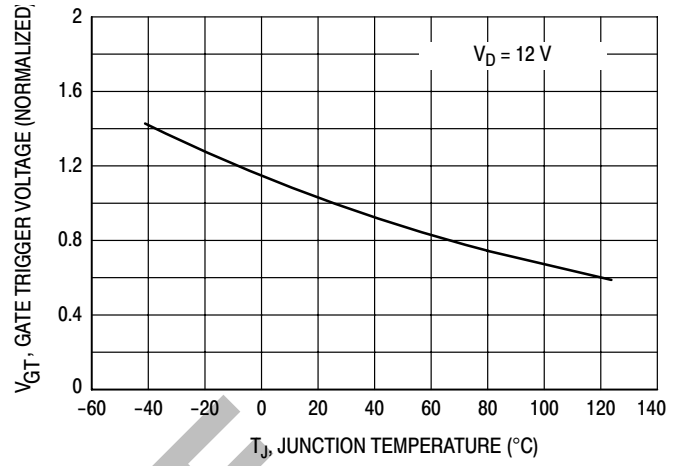

Figure 7. Typical Gate Trigger Voltage versus Temperature

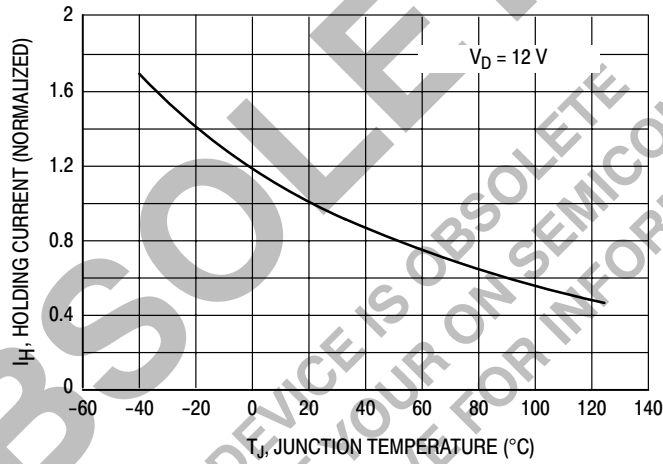
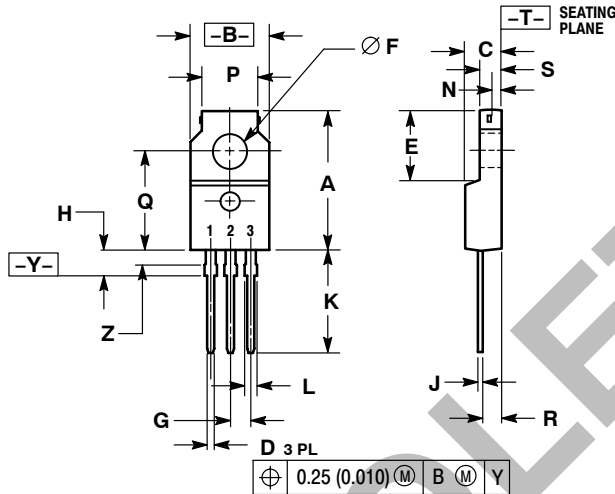

Figure 8. Typical Holding Current versus Temperature

MCR225-8FP, MCR225-10FP

PACKAGE DIMENSIONS

ISOLATED TO-220 Full Pack CASE 221C-02 ISSUE C



- NOTES:
1. DIMENSIONING AND TOLERANCING PER ANSI Y14.5M, 1982.
 2. CONTROLLING DIMENSION: INCH.
 3. LEAD DIMENSIONS UNCONTROLLED WITHIN DIMENSION Z.

DIM	INCHES		MILLIMETERS	
	MIN	MAX	MIN	MAX
A	0.680	0.700	17.28	17.78
B	0.388	0.408	9.86	10.36
C	0.175	0.195	4.45	4.95
D	0.025	0.040	0.64	1.01
E	0.340	0.355	8.64	9.01
F	0.140	0.150	3.56	3.81
G	0.100 BSC		2.54 BSC	
H	0.110	0.155	2.80	3.93
J	0.018	0.028	0.46	0.71
K	0.500	0.550	12.70	13.97
L	0.045	0.070	1.15	1.77
N	0.049	---	1.25	---
P	0.270	0.290	6.86	7.36
Q	0.480	0.500	12.20	12.70
R	0.090	0.120	2.29	3.04
S	0.105	0.115	2.67	2.92
Z	0.070	0.090	1.78	2.28

- STYLE 2:
PIN 1. CATHODE
2. ANODE
3. GATE

ON Semiconductor and **ON** are registered trademarks of Semiconductor Components Industries, LLC (SCILLC). SCILLC reserves the right to make changes without further notice to any products herein. SCILLC makes no warranty, representation or guarantee regarding the suitability of its products for any particular purpose, nor does SCILLC assume any liability arising out of the application or use of any product or circuit, and specifically disclaims any and all liability, including without limitation special, consequential or incidental damages. "Typical" parameters which may be provided in SCILLC data sheets and/or specifications can and do vary in different applications and actual performance may vary over time. All operating parameters, including "Typicals" must be validated for each customer application by customer's technical experts. SCILLC does not convey any license under its patent rights nor the rights of others. SCILLC products are not designed, intended, or authorized for use as components in systems intended for surgical implant into the body, or other applications intended to support or sustain life, or for any other application in which the failure of the SCILLC product could create a situation where personal injury or death may occur. Should Buyer purchase or use SCILLC products for any such unintended or unauthorized application, Buyer shall indemnify and hold SCILLC and its officers, employees, subsidiaries, affiliates, and distributors harmless against all claims, costs, damages, and expenses, and reasonable attorney fees arising out of, directly or indirectly, any claim of personal injury or death associated with such unintended or unauthorized use, even if such claim alleges that SCILLC was negligent regarding the design or manufacture of the part. SCILLC is an Equal Opportunity/Affirmative Action Employer. This literature is subject to all applicable copyright laws and is not for resale in any manner.

PUBLICATION ORDERING INFORMATION

LITERATURE FULFILLMENT:
Literature Distribution Center for ON Semiconductor
P.O. Box 5163, Denver, Colorado 80217 USA
Phone: 303-675-2175 or 800-344-3860 Toll Free USA/Canada
Fax: 303-675-2176 or 800-344-3867 Toll Free USA/Canada
Email: orderlit@onsemi.com

N. American Technical Support: 800-282-9855 Toll Free
USA/Canada
Europe, Middle East and Africa Technical Support:
Phone: 421 33 790 2910
Japan Customer Focus Center
Phone: 81-3-5773-3850

ON Semiconductor Website: www.onsemi.com
Order Literature: <http://www.onsemi.com/orderlit>
For additional information, please contact your local Sales Representative