

# NCP1512

## Advance Information PWM Buck Converter with a Very Low Iq During Low Load Conditions

The NCP1512 is a tri-mode regulator that operates either as a Synchronized PWM Buck Converter, PWM Buck Converter with internal oscillator or as a Pulsed Switching Regulator. If a synchronization signal is present, the NCP1512 operates as a current mode PWM converter with synchronous rectification. The optional external frequency input signal allows the user to control the location of the spurious frequency noise generated by a PWM converter. The Pulsed Switching Regulator mode is active when the Sync Pin is Low. The Pulsed Mode is an extremely low quiescent current Buck Converter. NCP1512 operates in a PWM mode with an internal oscillator when the Sync Pin is held high. The NCP1512 configuration allows the flexibility of efficient high power operation and low input current during system sleep modes.

### Features

- Synchronous Rectification for Higher Efficiency in PWM Mode
- Pulsed Switching Mode Operation for Low Current Consumption at Low Loads
- Integrated MOSFETs and Feedback Circuits
- Cycle-by-Cycle Current Limit
- Automatic Switching Between PWM, with External or Internal Oscillator, and Pulsed Mode
- Operating Frequency Range of 450 to 1000 kHz
- Internal 1.0 MHz Oscillator
- Thermal Limit Protection
- Built-in Slope Compensation for Current Mode PWM Converter
- 2.5, 2.85, 3.0, 3.3 Fixed Output Voltages
- Shutdown Current Consumption of 0.2  $\mu$ A
- Pb Free Package for Green Manufacturing

### Applications

- Cellular Phones and Pagers
- PDA
- Digital Cameras
- Supplies for DSP Cores
- Portable Applications

This document contains information on a new product. Specifications and information herein are subject to change without notice.



ON Semiconductor®

<http://onsemi.com>



9 PIN  
MICRO BUMP  
FC SUFFIX  
CASE 499E

### MARKING DIAGRAM



XX = Device Code  
YY = Year  
WW = Work Week

### PIN CONNECTIONS

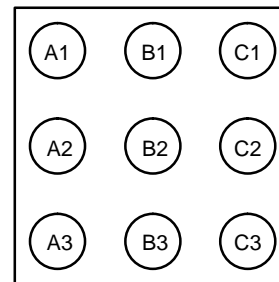

Pin: A1. - GNDP  
A2. - LX  
A3. - VCC  
B1. - SYNC  
B2. - GNDA  
B3. - FB  
C1. - SHD  
C2. - CB1  
C3. - CB0

(Bottom View)

### ORDERING INFORMATION

Device	Package	Shipping
NCP1512FCT1G	9 Pin Pb Free Micro Bump	TBD

# NCP1512

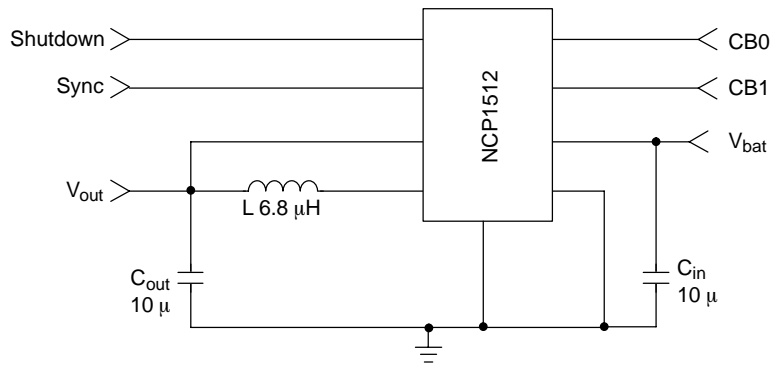

Figure 1. Applications Circuit

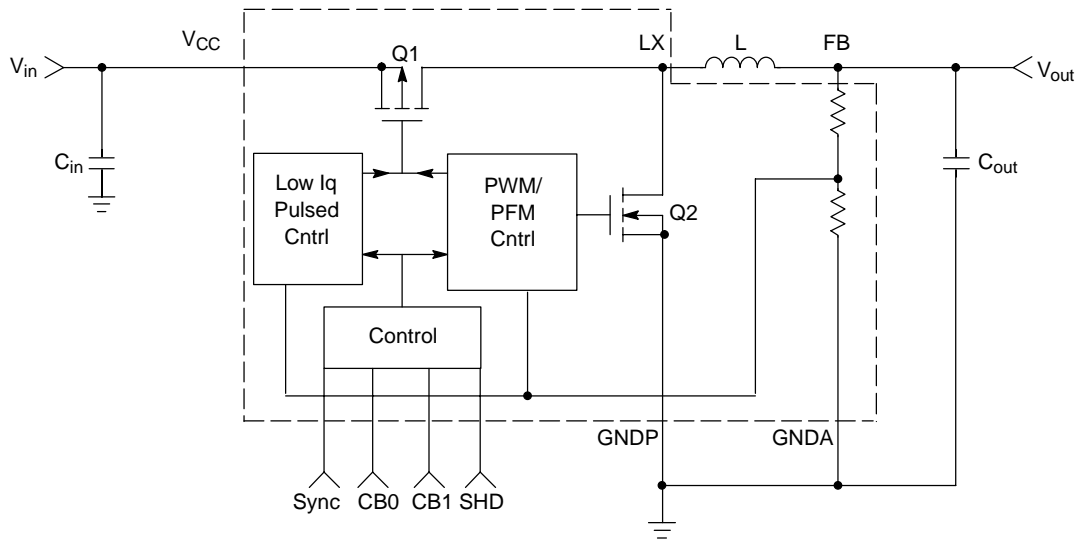

Figure 2. Block Diagram

# NCP1512

## PIN FUNCTION DESCRIPTION

Pin No.	Symbol	Type	Description
A1	GNDP	Power Ground	Ground Connection for the NFET Power Stage.
A2	LX	Analog Output	Connection from Power Pass Elements to the Inductor.
A3	VCC	Analog Input	Power Supply Input for Power and Analog $V_{CC}$ .
B1	SYNC	Analog Input	Synchronization input for the PWM converter. If a clock signal is present, the converter uses the rising edge for the turn on. If this pin is low, the converter is in the Pulsed mode. If this pin is high, the converter uses the internal oscillator for the PWM mode. This pin contains an internal pull down resistor.
B2	GND A	Analog Ground	Ground connection for the Analog Section of the IC. This is the GND for the FB, Ref, Sync, CB, and SHD pins.
B3	FB	Analog Input	Feedback Voltage from the Output of the Power Supply.
C1	SHD	Analog Input	Enable for Switching Regulator. This Pin is Active High to enable the NCP1512. The SHD Pin has an internal pull down resistor to force the converter off if this pin is not connected to the external circuit.
C2	CB1	Analog Input	Selects $V_{out}$ . This pin contains an internal pull up resistor.
C3	CB0	Analog Input	Selects $V_{out}$ . This pin contains an internal pull down resistor.

## MAXIMUM RATINGS (Note 1)

Rating	Symbol	Value	Unit
Maximum Voltage All Pins	$V_{max}$	5.5	V
Maximum Operating Voltage All Pins	$V_{max}$	5.2	V
Thermal Resistance, Junction-to-Air	$R_{ja}$	159	°C/W
Operating Ambient Temperature Range	$T_A$	-30 to 85	°C
ESD Withstand Voltage	Human Body Model (Note 1) Machine Model (Note 1)	$V_{ESD}$ > 2500 > 100	V
Moisture Sensitivity	MSL	Level 1	
Storage Temperature Range	$T_{stg}$	-55 to 150	°C
Junction Operating Temperature	$T_J$	-30 to 125	°C

- This device series contains ESD protection and exceeds the following tests:  
Human Body Model 2,000 V per MIL-STD-883, Method 3015.  
Machine Model Method 200 V.

# NCP1512

**ELECTRICAL CHARACTERISTICS** ( $V_{in} = 3.6\text{ V}$ ,  $V_o = 3.0\text{ V}$ ,  $T_A = 25^\circ\text{C}$ ,  $F_{syn} = 600\text{ kHz}$  50% Duty Cycle square wave for PWM mode;  $T_A = -30$  to  $85^\circ\text{C}$  for Min/Max values, unless otherwise noted.

Characteristic	Symbol	Min	Typ	Max	Unit
----------------	--------	-----	-----	-----	------

## VCC Pin

Quiescent Current of Sync Mode, $I_{out} = 0\text{ mA}$	Iq PWM	-	175	-	$\mu\text{A}$
Quiescent Current of PWM Mode, $I_{out} = 0\text{ mA}$	Iq PWM	-	185	-	$\mu\text{A}$
Quiescent Current of Pulsed Mode, $I_{out} = 0\text{ mA}$	Iq Pulsed	-	14	-	$\mu\text{A}$
Quiescent Current, SHD Low	Iq Off	-	0.1	1.0	$\mu\text{A}$
Input Voltage Range	Vin	2.5	-	5.2	V

## Sync Pin

Input Voltage	Vsync	-0.3	-	$V_{cc} + 0.3$	V
Frequency Operational Range	Fsync	450	600	1000	kHz
Minimum Synchronization Pulse Width	Dcsync Min	-	30	-	%
Maximum Synchronization Pulse Width	Dcsync Max	-	70	-	%
SYNC "H" Voltage Threshold	Vsynch	-	920	1200	mV
SYNC "L" Voltage Threshold	Vsyncl	400	830	-	mV
SYNC "H" Input Current, $V_{sync} = 3.6\text{ V}$	Isynch	-	2.2	-	$\mu\text{A}$
SYNC "L" Input Current, $V_{sync} = 0\text{ V}$	Isyncl	-0.5	-	-	$\mu\text{A}$

## Output Level Selection Pins

Input Voltage	Vcb	-0.3	-	$V_{cc} + 0.3$	V
CB0, CB1 "H" Voltage Threshold	Vcb h	-	920	1200	mV
CB0, CB1 "L" Voltage Threshold	Vcb l	400	830	-	mV
CB0, CB1 "H" Input Current, $CB = 3.6\text{ V}$	Icb h	-	2.2	-	$\mu\text{A}$
CB0, CB1 "L" Input Current, $CB = 0\text{ V}$	Icb l	-0.5	-	-	$\mu\text{A}$

## Shutdown Pin

Input Voltage	Vshd	-0.3	-	$V_{cc} + 0.3$	V
SHD "H" Voltage Threshold	Vshd h	-	920	1200	mV
SHD "L" Voltage Threshold	Vshd l	400	830	-	mV
SHD "H" Input Current, $SHD = 3.6\text{ V}$	Ishd h	-	2.2	-	$\mu\text{A}$
SHD "L" Input Current, $SHD = 0\text{ V}$	Ishd l	-0.5	-	-	$\mu\text{A}$

## Feedback Pin

Input Voltage	Vfb	-0.3	-	$V_{cc} + 0.3$	V
Input Current, $V_{fb} = 1.5\text{ V}$	Ifb	-	5.0	7.5	$\mu\text{A}$

## Sync PWM Mode Characteristics

Switching P-FET Current Limit	I lim	-	800	-	mA
Duty Cycle	DC	-	-	100	%
Minimum On Time	Ton min	-	75	-	nsec
Rdson Switching P-FET and N_FET	Rdson	-	0.23	-	$\Omega$
Switching P-FET and N-FET Leakage Current	Ileak	-	0	10	$\mu\text{A}$
Output Overvoltage Threshold	Vo	-	5.0	-	%

# NCP1512

**ELECTRICAL CHARACTERISTICS (continued)** ( $V_{in} = 3.6\text{ V}$ ,  $V_o = 3.0\text{ V}$ ,  $T_A = 25^\circ\text{C}$ ,  $F_{syn} = 600\text{ kHz}$  50% Duty Cycle square wave for PWM mode;  $T_A = -30$  to  $85^\circ\text{C}$  for Min/Max values, unless otherwise noted.)

Characteristic	Symbol	Min	Typ	Max	Unit
----------------	--------	-----	-----	-----	------

## Sync PWM Mode Characteristics (continued)

Feedback Voltage Accuracy, $V_{out}$ Set = 2.5 V $CB0 = L$ , $CB1 = L$	$V_{out}$	2.425	2.500	2.575	V
Feedback Voltage Accuracy, $V_{out}$ Set = 2.85 V $CB0 = L$ , $CB1 = H$	$V_{out}$	2.764	2.850	2.936	V
Feedback Voltage Accuracy, $V_{out}$ Set = 3.0 V $CB0 = H$ , $CB1 = H$	$V_{out}$	2.910	3.000	3.090	V
Feedback Voltage Accuracy, $V_{out}$ Set = 3.3 V $CB0 = H$ $CB1 = L$	$V_{out}$	3.201	3.300	3.399	V
Load Transient Response 10 to 100 mA Load Step	$V_{out}$	-	25	-	mV
Line Transient Response, $I_{out} = 100\text{ mA}$ 3.0 to 3.6 $V_{in}$ Line Step	$V_{out}$	-	$\pm 5.0$	-	mVpp

## PWM Mode with Internal Oscillator Characteristics

Switching P-FET Current Limit	$I_{lim}$	-	800	-	mA
Duty Cycle	DC	-	-	100	%
Minimum On Time	$T_{on\ min}$	-	75	-	nsec
Internal Oscillator Frequency	$F_{osc}$	800	1000	1240	kHz
$R_{dson}$ Switching P-FET and N_FET	$R_{dson}$	-	0.23	-	$\Omega$
Switching P-FET and N-FET Leakage Current	$I_{leak}$	-	0	10	$\mu\text{A}$
Output Overvoltage Threshold	$V_o$	-	5.0	-	%
Feedback Voltage Accuracy, $V_{out}$ Set = 2.5 V $CB0 = L$ , $CB1 = L$	$V_{out}$	2.425	2.500	2.575	V
Feedback Voltage Accuracy, $V_{out}$ Set = 1.3 V $CB0 = L$ , $CB1 = H$	$V_{out}$	2.764	2.850	2.936	V
Feedback Voltage Accuracy, $V_{out}$ Set = 1.5 V $CB0 = H$ , $CB1 = H$	$V_{out}$	2.910	3.000	3.090	V
Feedback Voltage Accuracy, $V_{out}$ Set = 1.89 V $CB0 = H$ $CB1 = L$	$V_{out}$	3.201	3.300	3.399	V
Load Transient Response 10 to 100 mA Load Step	$V_{out}$	-	25	-	mV
Line Transient Response, $I_{out} = 100\text{ mA}$ 3.0 to 3.6 $V_{in}$ Line Step	$V_{out}$	-	$\pm 5.0$	-	mVpp

## Pulsed Mode Characteristics

Minimum On Time	$T_{on\ min}$	-	50	-	nsec
Output Ripple Voltage, $I_{out} = 100\ \mu\text{A}$	$V_{out}$	-	40	-	mV
Feedback Voltage Accuracy, $V_{out}$ Set = 2.5 V $CB0 = L$ , $CB1 = L$	$V_{out}$	2.425	2.500	2.575	V
Feedback Voltage Accuracy, $V_{out}$ Set = 2.85 V $CB0 = L$ , $CB1 = H$	$V_{out}$	2.764	2.850	2.936	V
Feedback Voltage Accuracy, $V_{out}$ Set = 3.0 V $CB0 = H$ , $CB1 = H$	$V_{out}$	2.910	3.000	3.090	V
Feedback Voltage Accuracy, $V_{out}$ Set = 3.3 V $CB0 = H$ $CB1 = L$	$V_{out}$	3.201	3.300	3.399	V

**INTRODUCTION**

The NCP1512 is a tri-mode regulator intended for use in baseband supplies for portable equipment. Its unique features provide an efficient power supply for a portable device at full operating current, while also providing extremely low standby current for idle mode operation. When the system is idle, the user can activate the pulsed mode function. In this mode, the regulator provides a regulated low current output voltage keeping the system biased. When the device is in its normal operating mode, the regulator synchronizes to the system clock or uses an internal 1.0 MHz clock and turns into a switching regulator. This allows the regulator to provide efficient power to the system. This circuit is patent pending.

**Operation Description**

The Buck regulator is a synchronous rectifier PWM regulator with integrated MOSFETs. This regulator has a Pulsed function for low power modes to conserve power. The Tri PWM with external or internal oscillator/pulsed mode is an exclusive Patent Pending circuit.

For the PWM Synchronization mode, the operating frequency range for the NCP1512 is 450 to 1000 kHz. The output current of the PWM is optimized for 100 mA with a maximum current supply in excess of 300 mA for the 2.5 to 5.2 input voltage range.

If the Sync Pin is held low, the NCP1512 changes into the Pulsed mode. The Pulsed function assures the user of an extremely low input current and greatly reduced quiescent current when the users system is in a sleep mode. Internally to the NCP1512, the Synchronization pin has a pull down resistor to force the part into Pulsed mode when a clock signal is not present. The Pulsed mode supplies a current in excess of 30 mA.

If the Sync Pin is held high, NCP1512 enters a PWM mode with an internal 1.0 MHz oscillator. The PWM mode has the same operational characteristics (current limit, maximum output current, etc.) as the synchronized PWM mode. The Sync Pin threshold is fixed as noted in the Electrical Characteristics table.

**Table 1. Sync Pin Input with Corresponding Operational Mode of NCP1512**

Sync Pin State	Operational Mode
Low	Low $I_q$ Pulsed Mode Operation
High	PWM Using Internal Oscillator for the Clock
Clock	PWM Using Rising Edge of Clock Signal to Turn On PFET Pass Element

**PWM Mode with External Synchronization Signal**

During normal operation, a synchronization pulse acts as the clock for the DC/DC controller. The rising edge of the clock pulls the gate of Q1 low allowing the inductor to charge. When the current through Q1 reaches either the current limit or feedback voltage reaches its limit, Q1 will turn off and Q2 will turn on. Q2 replaces the free wheeling diode typically associated with Buck Converters. Q2 will turn off when either a rising edge sync pulse is present or all the stored energy is depleted from the inductor.

The output voltage accuracy in the PWM mode is well within 3% of the nominal set value. An overvoltage protection circuit is present in the PWM mode to limit the positive voltage spike due to fast load transient conditions. If the OVP comparator is activated, the duty cycle will be 0% until the output voltage falls to the nominal level. The PWM also has the ability to go to 100% duty cycle for transient conditions and low input to output voltage differentials.

The PWM mode operates as a forced-PWM converter. Each switching cycle has a typical on-time of 75 nsec. NCP1512 has two protection circuits that can eliminate the minimum on time for the cycle. When tripped, the overvoltage protection or the thermal shutdown overrides the gate drive of the high side MOSFET.

# NCP1512

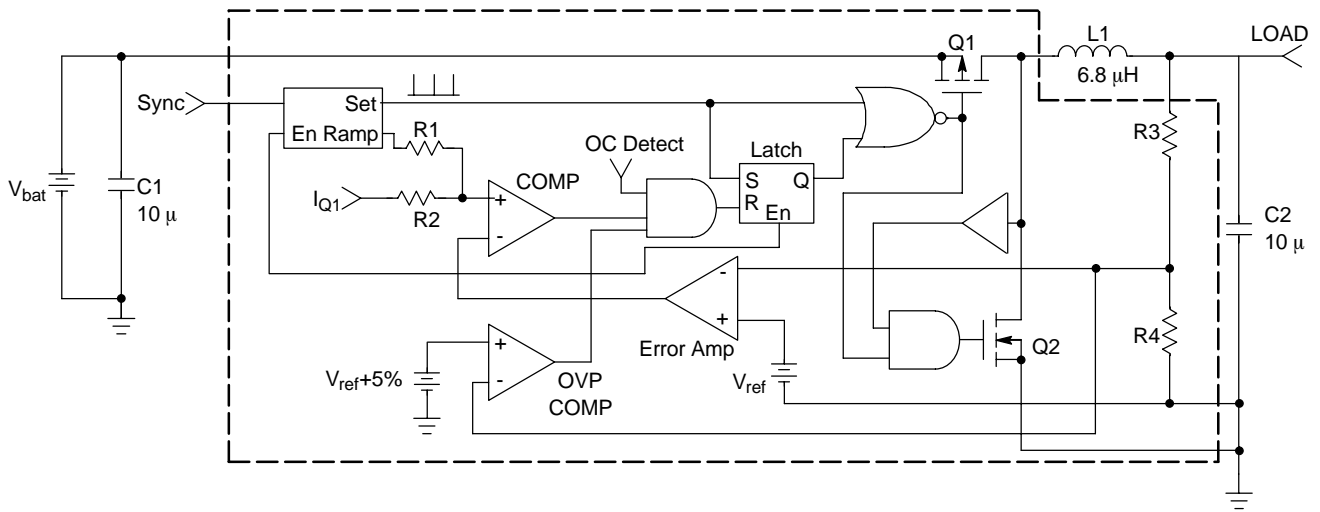

Figure 3. PWM Circuit Schematic

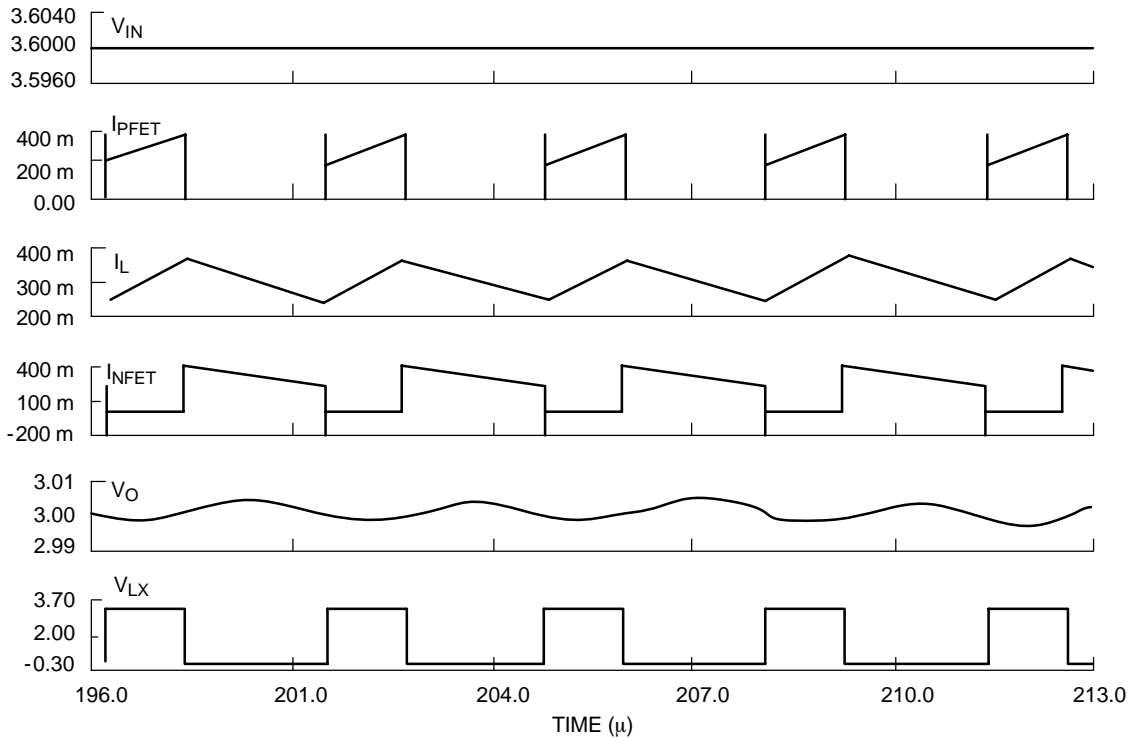

Figure 4. Waveforms During PWM Operation

### PWM Mode with Internal Oscillator

If a synchronization signal is not available, the converter has a 1.0 MHz internal oscillator available. The Sync Pin must be held high to enter this mode. The characteristics of the PWM mode with internal oscillator are similar to the Sync PWM Mode.

### Pulsed Mode

During low-level current output, NCP1512 can enter a low current consumption mode when the Sync Pin is held low. This mode will typically have a free running frequency and an output voltage ripple similar to a PFM mode. The advantage of the Pulsed mode is much lower  $I_q$  (14  $\mu A$ ) and drastically higher efficiency compared with PWM and PFM modes in low output loads.

# NCP1512

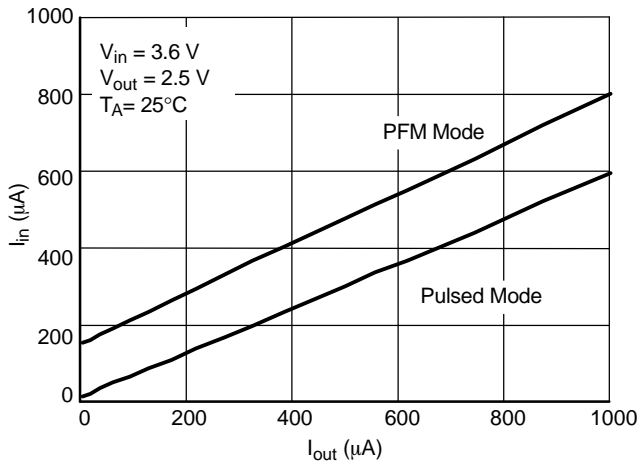

Figure 5. Input Current Comparison

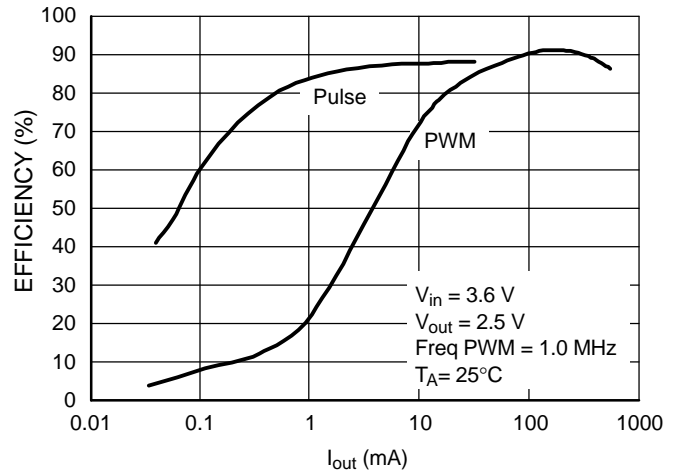

Figure 6. PWM versus Pulse Efficiency Comparison

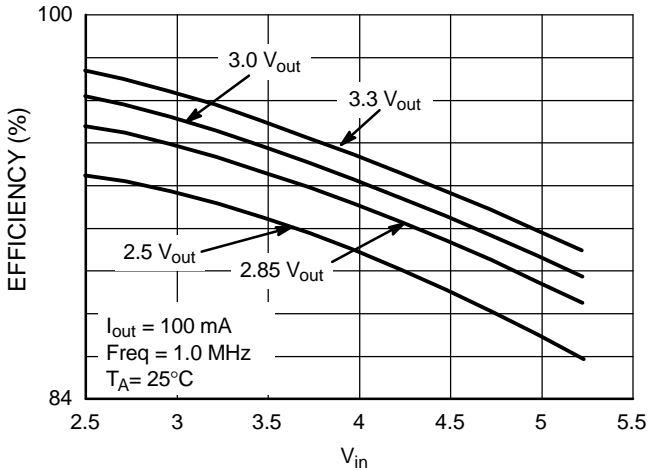

Figure 7.  $V_{in}$  versus Efficiency in PWM Mode

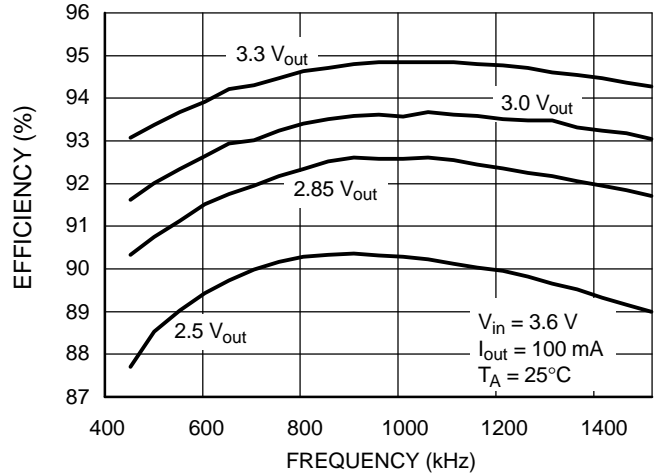

Figure 8. Frequency versus Efficiency in PWM Mode

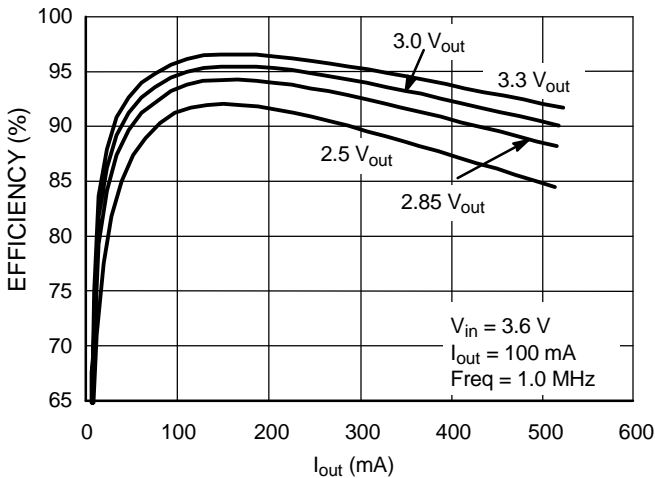

Figure 9.  $I_{out}$  versus Efficiency in PWM Mode

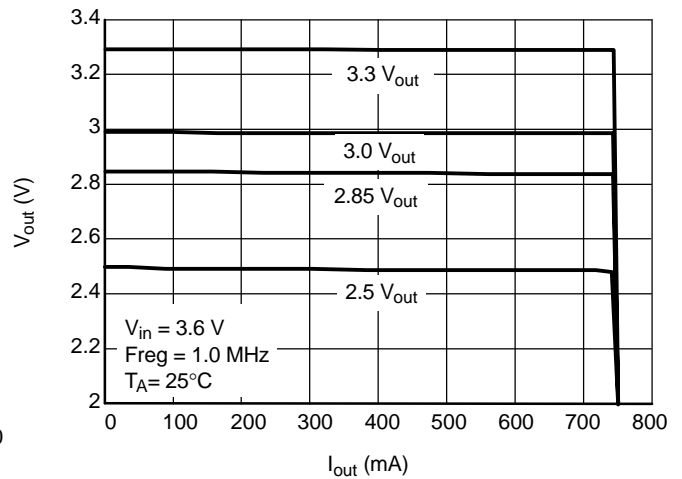

Figure 10.  $V_{out}$  versus  $I_{out}$  in PWM Mode



# NCP1512

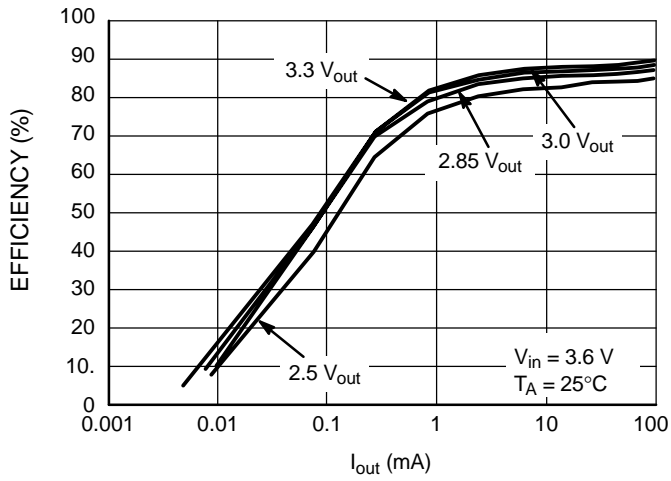

Figure 11.  $I_{out}$  versus Efficiency in Pulse Mode

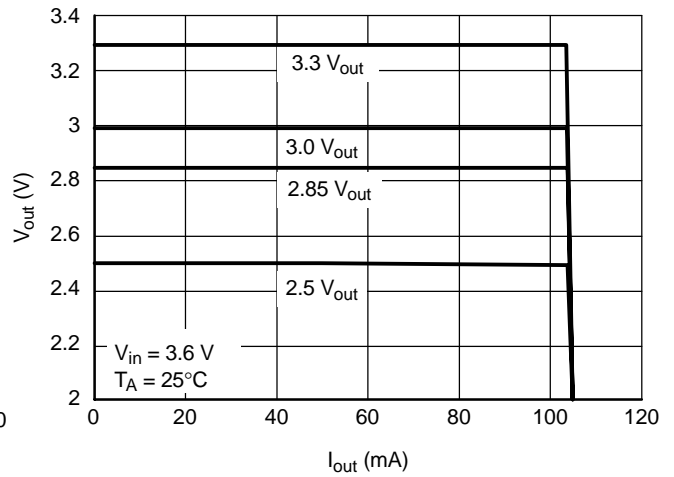

Figure 12.  $V_{out}$  versus Efficiency in Pulse Mode

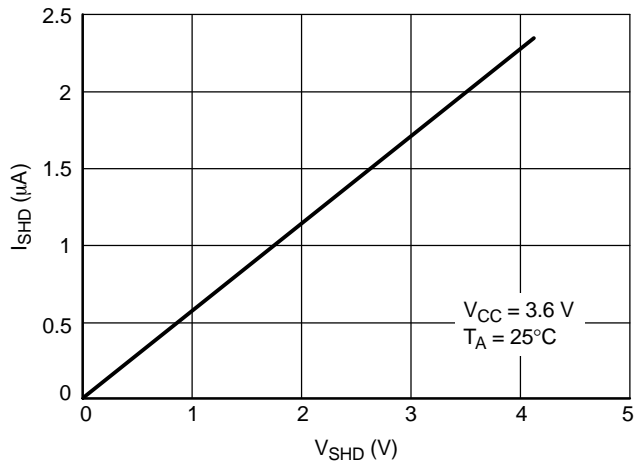

Figure 13. Input Current versus Voltage for the Shutdown Pin

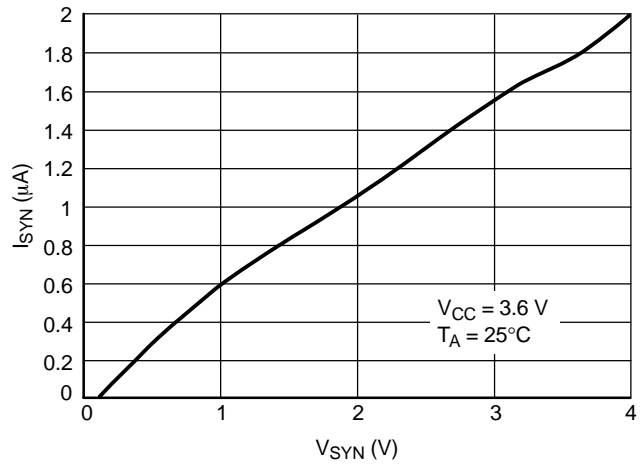

Figure 14. Input Current versus Voltage for the Synchronization Pin

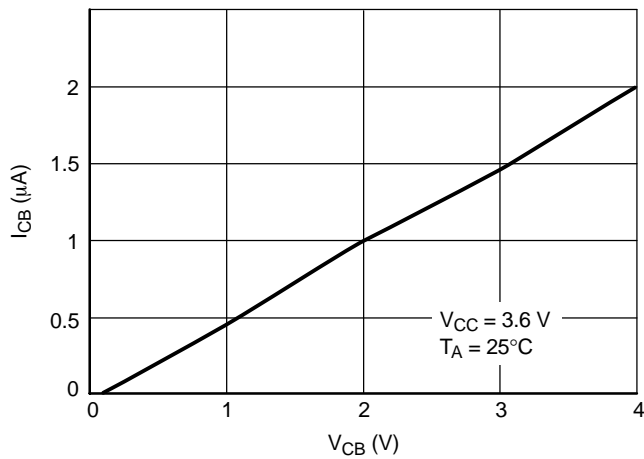

Figure 15. Input Current versus Voltage for the CB Pins

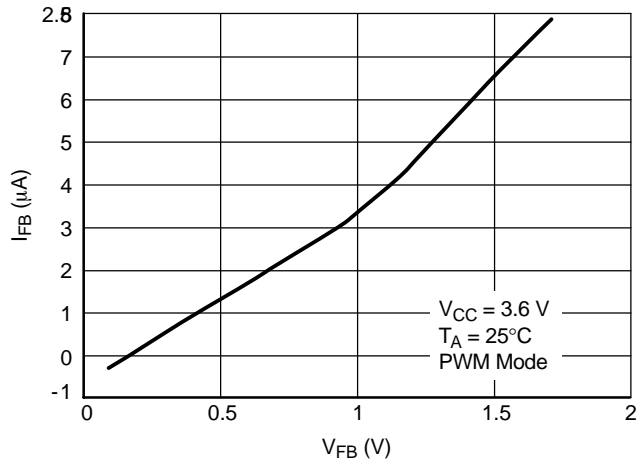

Figure 16. Input Current versus Voltage for the Feedback Pin

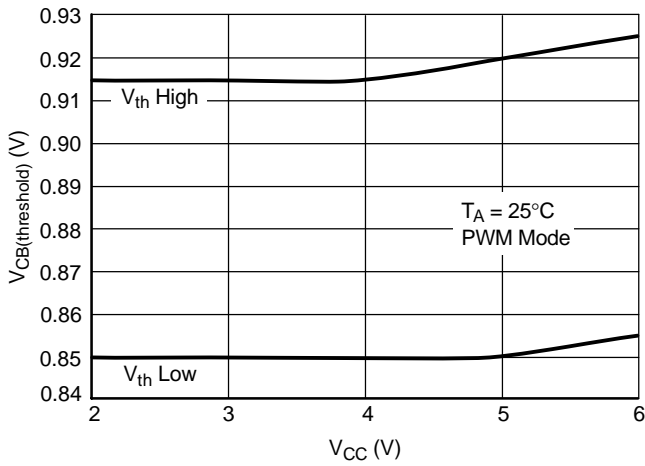

Figure 17.  $V_{CC}$  Input Voltage versus CB Threshold

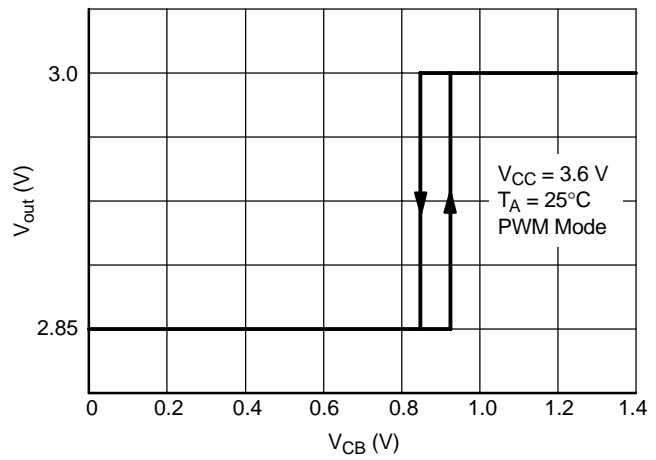

Figure 18. Transition Level of CB Pins

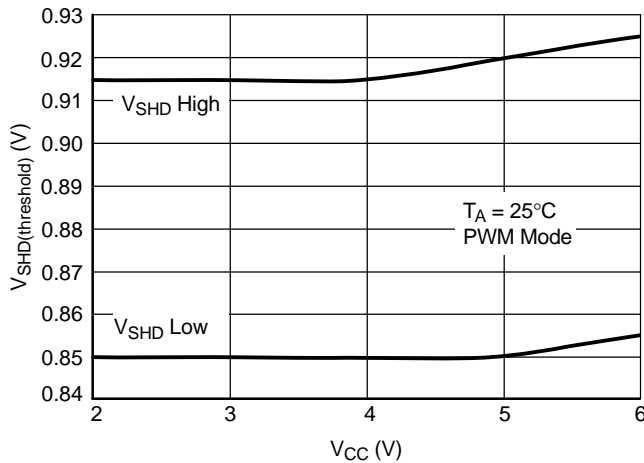

Figure 19. Input Voltage versus Shutdown Voltage

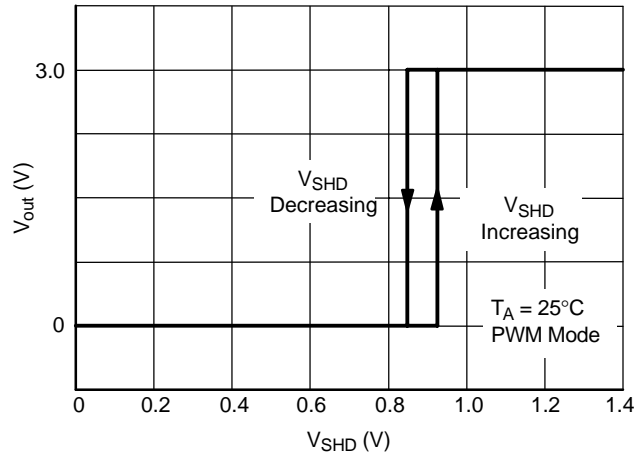

Figure 20. Output Voltage versus Shutdown Pin Voltage

**Voltage Output Selection**

The CB1 and CB0 pins control the output voltage selection. The output voltages are listed in Table 2. The CB pins contain internal resistors to force the NCP1512 to 2.85  $V_{out}$  if they are not connected to an external circuit. The CB0 has a pull down resistor and the CB1 has a pull up resistor. The CB Pin thresholds are fixed as noted in the Electrical Characteristics table.

**Shutdown Pin**

The Shutdown Pin enables the operation of the device. The Shutdown Pin has an internal pull down resistor to force the NCP1512 into the off mode if this pin is floating due to the external circuit. The Shutdown Pin threshold is fixed as noted in the Electrical Characteristics table. During Startup, the NCP1512 has a soft start function to limit fast  $dV/dt$  and eliminate overshoot on the output.

**Thermal Shutdown**

Internal Thermal Shutdown circuitry is provided to protect the integrated circuit in the event at the maximum

junction temperature is exceeded. When activated, typically at 160°C, the PWM latch is reset and the linear regulator control circuitry is disabled. The thermal shutdown circuit is designed with 25°C of hysteresis. This means that the PWM latch and the regulator control circuitry cannot be re-enabled until the die temperature drops by this amount. This feature is provided to prevent catastrophic failures from accidental device overheating. **It is not intended as a substitute for proper heatsinking.** The NCP1512 is contained in a 9 pin micro bump package.

Table 2. Truth Table for CB0 and CB1 with the Corresponding Output Voltage

CB0	CB1	$V_{out}$ (V)
0	0	2.5
0	1	2.85
1	1	3.0
1	0	3.3

# NCP1512

## PACKAGE DIMENSIONS

### 9 PIN MICRO BUMP FC SUFFIX CASE 499E-01 ISSUE O

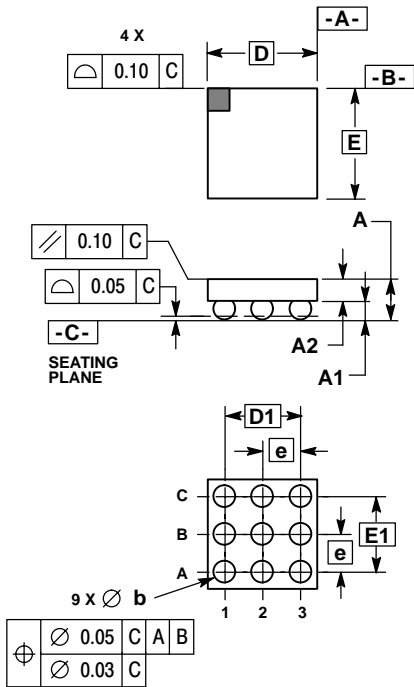



#### NOTES:

1. DIMENSIONING AND TOLERANCING PER ANSI Y14.5M, 1982.
2. CONTROLLING DIMENSION: MILLIMETERS.
3. COPLANARITY APPLIES TO SPHERICAL CROWNS OF SOLDER BALLS.

DIM	MILLIMETERS	
	MIN	MAX
A	0.540	0.660
A1	0.210	0.270
A2	0.330	0.390
D	1.450 BSC	
E	1.450 BSC	
b	0.290	0.340
e	0.500 BSC	
D1	1.000 BSC	
E1	1.000 BSC	

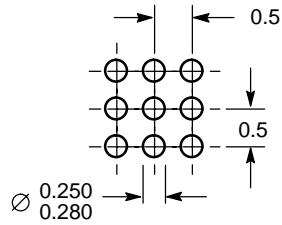
### RECOMMENDED PCB FOOTPRINT



**ON Semiconductor** and  are registered trademarks of Semiconductor Components Industries, LLC (SCILLC). SCILLC reserves the right to make changes without further notice to any products herein. SCILLC makes no warranty, representation or guarantee regarding the suitability of its products for any particular purpose, nor does SCILLC assume any liability arising out of the application or use of any product or circuit, and specifically disclaims any and all liability, including without limitation special, consequential or incidental damages. "Typical" parameters which may be provided in SCILLC data sheets and/or specifications can and do vary in different applications and actual performance may vary over time. All operating parameters, including "Typicals" must be validated for each customer application by customer's technical experts. SCILLC does not convey any license under its patent rights nor the rights of others. SCILLC products are not designed, intended, or authorized for use as components in systems intended for surgical implant into the body, or other applications intended to support or sustain life, or for any other application in which the failure of the SCILLC product could create a situation where personal injury or death may occur. Should Buyer purchase or use SCILLC products for any such unintended or unauthorized application, Buyer shall indemnify and hold SCILLC and its officers, employees, subsidiaries, affiliates, and distributors harmless against all claims, costs, damages, and expenses, and reasonable attorney fees arising out of, directly or indirectly, any claim of personal injury or death associated with such unintended or unauthorized use, even if such claim alleges that SCILLC was negligent regarding the design or manufacture of the part. SCILLC is an Equal Opportunity/Affirmative Action Employer.

## PUBLICATION ORDERING INFORMATION

### Literature Fulfillment:

Literature Distribution Center for ON Semiconductor  
P.O. Box 5163, Denver, Colorado 80217 USA  
**Phone:** 303-675-2175 or 800-344-3860 Toll Free USA/Canada  
**Fax:** 303-675-2176 or 800-344-3867 Toll Free USA/Canada  
**Email:** [orderlit@onsemi.com](mailto:orderlit@onsemi.com)

**N. American Technical Support:** 800-282-9855 Toll Free USA/Canada

**JAPAN:** ON Semiconductor, Japan Customer Focus Center  
2-9-1 Kamimeguro, Meguro-ku, Tokyo, Japan 153-0051  
**Phone:** 81-3-5773-3850

**ON Semiconductor Website:** <http://onsemi.com>

For additional information, please contact your local  
Sales Representative.