

# NCV6334B

## Buck Converter - Synchronous 3 MHz, 2 A

The NCV6334B, a family of synchronous buck converters, which is optimized to supply different sub systems of portable applications powered by one cell Li-ion or three cell Alkaline/NiCd/NiMH batteries. The devices are able to deliver up to 2 A on an external adjustable voltage. Operation with 3 MHz switching frequency allows employing small size inductor and capacitors. Input supply voltage feedforward control is employed to deal with wide input voltage range. Synchronous rectification and automatic PWM/PFM power save mode offer improved system efficiency. The NCV6334B is in a space saving, low profile 2.0 x 2.0 x 0.75 mm WDFN-8 package.

### Features

- 2.3 V to 5.5 V Input Voltage Range
- External Adjustable Voltage
- Up to 2 A Output Current
- 3 MHz Switching Frequency
- Synchronous Rectification
- Automatic Power Save
- Enable Input
- Power Good Output Option
- Soft Start
- Over Current Protection
- Active Discharge When Disabled
- Thermal Shutdown Protection
- WDFN-8, 2 x 2 mm, 0.5 mm Pitch Package
- Maximum 0.8 mm Height for Super Thin Applications
- This is a Pb-Free Device

### Typical Applications

- Cellular Phones, Smart Phones, and PDAs
- Portable Media Players
- Digital Still Cameras
- Wireless and DSL Modems
- USB Powered Devices
- Point of Load
- Game and Entertainment System



ON Semiconductor®

<http://onsemi.com>



WDFN8  
CASE 511BT

### MARKING DIAGRAM

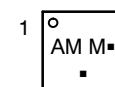

AM = Specific Device Code  
M = Date Code  
▪ = Pb-Free Package

(\*Note: Microdot may be in either location)

### PINOUT

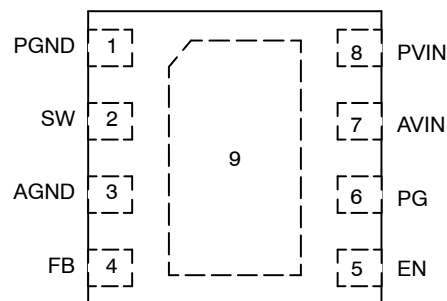

(Top View)

### ORDERING INFORMATION

See detailed ordering, marking and shipping information in the package dimensions section on page 2 of this data sheet.

## NCV6334B

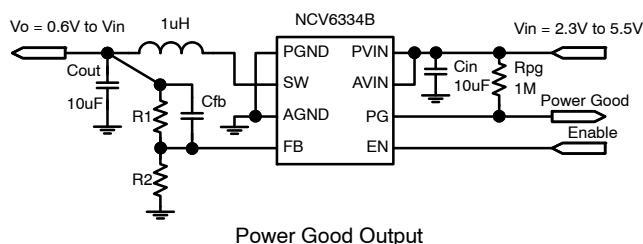

**Figure 1. Typical Application Circuits**

### PIN DESCRIPTION

| Pin | Name | Type           | Description  |
|-----|------|----------------|--|
| 1   | PGND | Power Ground   | Power Ground for power, analog blocks. Must be connected to the system ground.   |
| 2   | SW   | Power Output   | Switch Power pin connects power transistors to one end of the inductor.  |
| 3   | AGND | Analog Ground  | Analog Ground analog and digital blocks. Must be connected to the system ground.   |
| 4   | FB   | Analog Input   | Feedback Voltage from the buck converter output. This is the input to the error amplifier. This pin is connected to the resistor divider network between the output and AGND.  |
| 5   | EN   | Digital Input  | Enable of the IC. High level at this pin enables the device. Low level at this pin disables the device.  |
| 6   | PG   | Digital Output | PG pin is for NCV6334B with Power Good option. It is open drain output. Low level at this pin indicates the device is not in power good, while high impedance at this pin indicates the device is in power good.                     |
| 7   | AVIN | Analog Input   | Analog Supply. This pin is the analog and the digital supply of the device. An optional 1 $\mu$ F or larger ceramic capacitor bypasses this input to the ground. This capacitor should be placed as close as possible to this input. |
| 8   | PVIN | Power Input    | Power Supply Input. This pin is the power supply of the device. A 10 $\mu$ F or larger ceramic capacitor or must bypass this input to the ground. This capacitor should be placed as close a possible to this input.                 |
| 9   | PAD  | Exposed Pad    | Exposed Pad. Must be soldered to system ground to achieve power dissipation performances. This pin is internally unconnected   |

### ORDERING INFORMATION

| Device          | Marking | Package            | Shipping <sup>†</sup> |
|-----------------|---------|--------------------|-----------------------|
| NCV6334BMTAATBG | AM      | WDFN8<br>(Pb-Free) | 3000 / Tape & Reel    |

<sup>†</sup>For information on tape and reel specifications, including part orientation and tape sizes, please refer to our Tape and Reel Packaging Specifications Brochure, BRD8011/D.

# NCV6334B

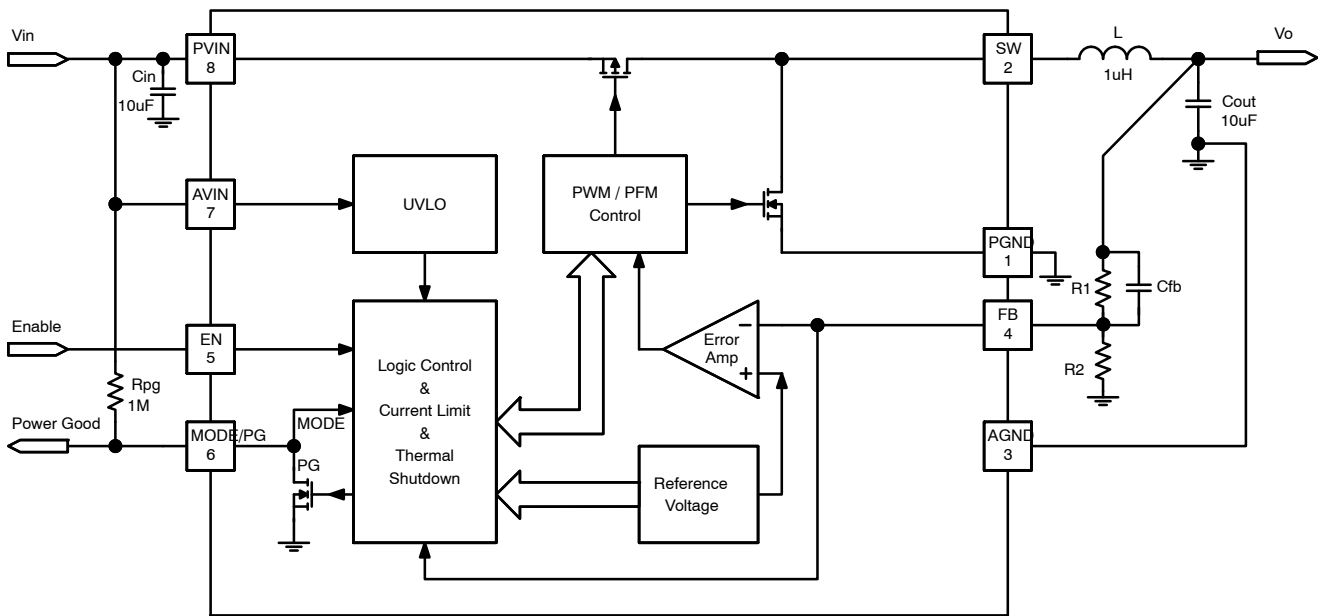

Figure 2. Functional Block Diagram

## MAXIMUM RATINGS

| Rating   | Symbol               | Value |      | Unit |
|--|----------------------|-------|------|------|
|  |                      | Min   | Max  |      |
| Input Supply Voltage to GND                      | $V_{PVIN}, V_{AVIN}$ | -0.3  | 7.0  | V    |
| Switch Node to GND                               | $V_{SW}$             | -0.3  | 7.0  | V    |
| EN, PG to GND                                    | $V_{EN}, V_{PG}$     | -0.3  | 7.0  | V    |
| FB to GND  | $V_{FB}$             | -0.3  | 2.5  | V    |
| Human Body Model (HBM) ESD Rating (Note 1)       | ESD HBM              |       | 2000 | V    |
| Machine Model (MM) ESD Rating (Note 1)           | ESD MM               |       | 200  | V    |
| Latchup Current (Note 2)                         | $I_{LU}$             | -100  | 100  | mA   |
| Operating Junction Temperature Range (Note 3)    | $T_J$                | -40   | 125  | °C   |
| Operating Ambient Temperature Range              | $T_A$                | -40   | 85   | °C   |
| Storage Temperature Range                        | $T_{STG}$            | -55   | 150  | °C   |
| Thermal Resistance Junction-to-Top Case (Note 4) | $R_{\theta JC}$      | 12    |      | °C/W |
| Thermal Resistance Junction-to-Board (Note 4)    | $R_{\theta JB}$      | 30    |      | °C/W |
| Thermal Resistance Junction-to-Ambient (Note 4)  | $R_{\theta JA}$      | 62    |      | °C/W |
| Power Dissipation (Note 5)                       | $P_D$                | 1.6   |      | W    |
| Moisture Sensitivity Level (Note 6)              | MSL                  | 1     |      | -    |

Stresses exceeding Maximum Ratings may damage the device. Maximum Ratings are stress ratings only. Functional operation above the Recommended Operating Conditions is not implied. Extended exposure to stresses above the Recommended Operating Conditions may affect device reliability.

- This device series contains ESD protection and passes the following tests:  
Human Body Model (HBM)  $\pm 2.0$  kV per JEDEC standard: JESD22-A114.  
Machine Model (MM)  $\pm 200$  V per JEDEC standard: JESD22-A115.
- Latchup Current per JEDEC standard: JESD78 Class II.
- The thermal shutdown set to 160°C (typical) avoids potential irreversible damage on the device due to power dissipation.
- The thermal resistance values are dependent of the PCB heat dissipation. Board used to drive these data was an 80 x 50 mm NCP6334EVB board. It is a multilayer board with 1 once internal power and ground planes and 2-once copper traces on top and bottom of the board. If the copper traces of top and bottom are 1 once too,  $R_{\theta JC} = 11^\circ\text{C/W}$ ,  $R_{\theta JB} = 30^\circ\text{C/W}$ , and  $R_{\theta JA} = 72^\circ\text{C/W}$ .
- The maximum power dissipation ( $P_D$ ) is dependent on input voltage, maximum output current and external components selected.
- Moisture Sensitivity Level (MSL): 1 per IPC/JEDEC standard: J-STD-020A.

# NCV6334B

**ELECTRICAL CHARACTERISTICS** ( $V_{IN} = 3.6\text{ V}$ ,  $V_{OUT} = 1.8\text{ V}$ ,  $L = 1\ \mu\text{H}$ ,  $C = 10\ \mu\text{F}$ , typical values are referenced to  $T_J = 25^\circ\text{C}$ , Min and Max values are referenced to  $T_J$  up to  $125^\circ\text{C}$ , unless other noted.)

| Symbol | Characteristics | Test Conditions | Min | Typ | Max | Unit |
|--------|-----------------|-----------------|-----|-----|-----|------|
|--------|-----------------|-----------------|-----|-----|-----|------|

## SUPPLY VOLTAGE

|          |                              |           |     |   |     |   |
|----------|------------------------------|-----------|-----|---|-----|---|
| $V_{IN}$ | Input Voltage $V_{IN}$ Range | (Note 10) | 2.3 | – | 5.5 | V |
|----------|------------------------------|-----------|-----|---|-----|---|

## SUPPLY CURRENT

|          |                                   |  |   |    |   |               |
|----------|-----------------------------------|--|---|----|---|---------------|
| $I_Q$    | $V_{IN}$ Quiescent Supply Current | EN high, no load, no switching, PFM Mode | – | 30 | – | $\mu\text{A}$ |
| $I_{SD}$ | $V_{IN}$ Shutdown Current         | EN low                                   | – | –  | 1 | $\mu\text{A}$ |

## OUTPUT VOLTAGE

|           |                               |   |     |      |          |     |
|-----------|-------------------------------|---|-----|------|----------|-----|
| $V_{OUT}$ | Output Voltage Range          | (Note 7)  | 0.6 | –    | $V_{IN}$ | V   |
| $V_{FB}$  | FB Voltage                    | PWM Mode  | 594 | 600  | 606      | mV  |
|           | FB Voltage in Load Regulation | $V_{IN} = 3.6\text{ V}$ , $I_{OUT}$ from 200 mA to $I_{OUTMAX}$ , PWM mode (Note 7)                           | –   | –0.5 | –        | %/A |
|           | FB Voltage in Line Regulation | $I_{OUT} = 200\text{ mA}$ , $V_{IN}$ from MAX ( $V_{NOM} + 0.5\text{ V}$ , 2.3 V) to 5.5 V, PWM mode (Note 7) | –   | 0    | –        | %/V |
| $D_{MAX}$ | Maximum Duty Cycle            | (Note 7)  | –   | 100  | –        | %   |

## OUTPUT CURRENT

|              |                           |          |     |     |     |   |
|--------------|---------------------------|----------|-----|-----|-----|---|
| $I_{OUTMAX}$ | Output Current Capability | (Note 7) | 2.0 | –   | –   | A |
| $I_{LIM}$    | Output Peak Current Limit |          | 2.3 | 2.8 | 3.3 | A |

## VOLTAGE MONITOR

|             |                                     |   |    |      |     |               |
|-------------|-------------------------------------|---|----|------|-----|---------------|
| $V_{INUV-}$ | $V_{IN}$ UVLO Falling Threshold     |   | –  | –    | 2.3 | V             |
| $V_{INHYS}$ | $V_{IN}$ UVLO Hysteresis            |   | 60 | –    | 200 | mV            |
| $V_{PGL}$   | Power Good Low Threshold            | $V_{OUT}$ falls down to cross the threshold (percentage of FB voltage) (Note 8)   | 87 | 90   | 92  | %             |
| $V_{PGHYS}$ | Power Good Hysteresis               | $V_{OUT}$ rises up to cross the threshold (percentage of Power Good Low Threshold ( $V_{PGL}$ ) voltage) (Note 8)       | 0  | 3    | 5   | %             |
| $T_{dPGH1}$ | Power Good High Delay in Start Up   | From EN rising edge to PG going high. (Note 8)  | –  | 1.15 | –   | ms            |
| $T_{dPGL1}$ | Power Good Low Delay in Shut Down   | From EN falling edge to PG going low. (Notes 7 and 8)   | –  | 8    | –   | $\mu\text{s}$ |
| $T_{dPGH}$  | Power Good High Delay in Regulation | From $V_{FB}$ going higher than 95% nominal level to PG going high. Not for the first time in start up. (Notes 7 and 8) | –  | 5    | –   | $\mu\text{s}$ |
| $T_{dPGL}$  | Power Good Low Delay in Regulation  | From $V_{FB}$ going lower than 90% nominal level to PG going low. (Notes 7 and 8)                                       | –  | 8    | –   | $\mu\text{s}$ |
| $V_{PG\_L}$ | Power Good Pin Low Voltage          | Voltage at PG pin with 5 mA sink current (Note 8)   | –  | –    | 0.3 | V             |
| $PG\_LK$    | Power Good Pin Leakage Current      | 3.6 V at PG pin when power good valid (Note 8)  | –  | –    | 100 | nA            |

## INTEGRATED MOSFETS

|             |                                |  |   |            |          |                  |
|-------------|--------------------------------|--|---|------------|----------|------------------|
| $R_{ON\_H}$ | High-Side MOSFET ON Resistance | $V_{IN} = 3.6\text{ V}$ (Note 9)<br>$V_{IN} = 5\text{ V}$ (Note 9) | – | 140<br>130 | 200<br>– | $\text{m}\Omega$ |
| $R_{ON\_L}$ | Low-Side MOSFET ON Resistance  | $V_{IN} = 3.6\text{ V}$ (Note 9)<br>$V_{IN} = 5\text{ V}$ (Note 9) | – | 110<br>100 | 140<br>– | $\text{m}\Omega$ |

7. Guaranteed by design, not tested in production.

8. Power Good function is for NCV6334B devices only.

9. Maximum value applies for  $T_J = 85^\circ\text{C}$ .

10. Operation above 5.5 V input voltage for extended periods may affect device reliability.

# NCV6334B

**ELECTRICAL CHARACTERISTICS** ( $V_{IN} = 3.6\text{ V}$ ,  $V_{OUT} = 1.8\text{ V}$ ,  $L = 1\ \mu\text{H}$ ,  $C = 10\ \mu\text{F}$ , typical values are referenced to  $T_J = 25^\circ\text{C}$ , Min and Max values are referenced to  $T_J$  up to  $125^\circ\text{C}$ , unless other noted.)

| Symbol | Characteristics | Test Conditions | Min | Typ | Max | Unit |
|--------|-----------------|-----------------|-----|-----|-----|------|
|--------|-----------------|-----------------|-----|-----|-----|------|

## SWITCHING FREQUENCY

|          |                            |  |     |     |     |     |
|----------|----------------------------|--|-----|-----|-----|-----|
| $F_{SW}$ | Normal Operation Frequency |  | 2.7 | 3.0 | 3.3 | MHz |
|----------|----------------------------|--|-----|-----|-----|-----|

## SOFT START

|          |                 |  |   |     |   |    |
|----------|-----------------|--|---|-----|---|----|
| $T_{SS}$ | Soft-Start Time | Time from EN to 90% of output voltage target | – | 0.4 | 1 | ms |
|----------|-----------------|--|---|-----|---|----|

## CONTROL LOGIC

|                |                       |  |     |     |     |               |
|----------------|-----------------------|--|-----|-----|-----|---------------|
| $V_{EN\_H}$    | EN Input High Voltage |  | 1.1 | –   | –   | V             |
| $V_{EN\_L}$    | EN Input Low Voltage  |  | –   | –   | 0.4 | V             |
| $V_{EN\_HYS}$  | EN Input Hysteresis   |  | –   | 270 | –   | mV            |
| $I_{EN\_BIAS}$ | EN Input Bias Current |  |     | 0.1 | 1   | $\mu\text{A}$ |

## OUTPUT ACTIVE DISCHARGE

|           |                                      |                 |    |     |     |          |
|-----------|--------------------------------------|-----------------|----|-----|-----|----------|
| $R_{DIS}$ | Internal Output Discharge Resistance | from SW to PGND | 75 | 500 | 700 | $\Omega$ |
|-----------|--------------------------------------|-----------------|----|-----|-----|----------|

## THERMAL SHUTDOWN

|               |                             |  |   |     |   |                  |
|---------------|-----------------------------|--|---|-----|---|------------------|
| $T_{SD}$      | Thermal Shutdown Threshold  |  | – | 160 | – | $^\circ\text{C}$ |
| $T_{SD\_HYS}$ | Thermal Shutdown Hysteresis |  | – | 25  | – | $^\circ\text{C}$ |

TYPICAL OPERATING CHARACTERISTICS

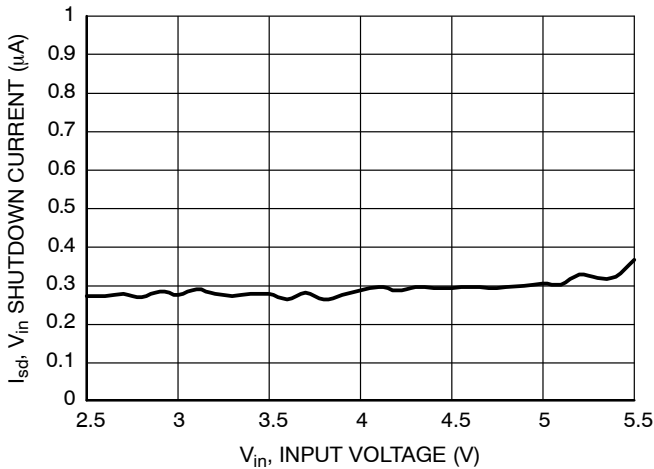

Figure 3. Standby Current vs. Input Voltage  
(EN = Low, T<sub>A</sub> = 25°C)

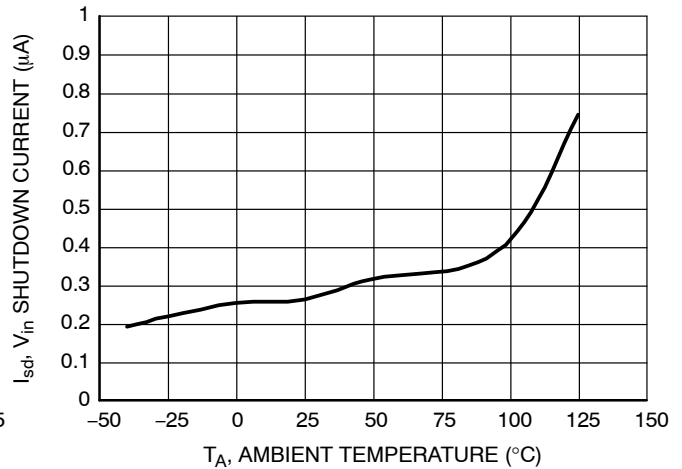

Figure 4. Standby Current vs. Temperature  
(EN = Low, V<sub>IN</sub> = 3.6 V)

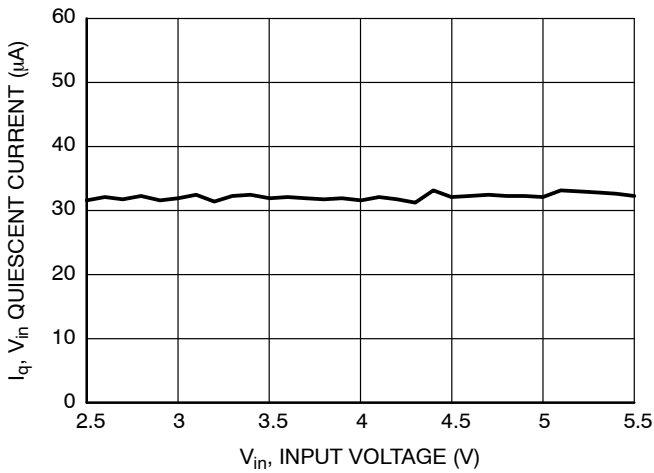

Figure 5. Quiescent Current vs. Input Voltage  
(EN = High, Open Loop, V<sub>OUT</sub> = 1.8 V,  
T<sub>A</sub> = 25°C)

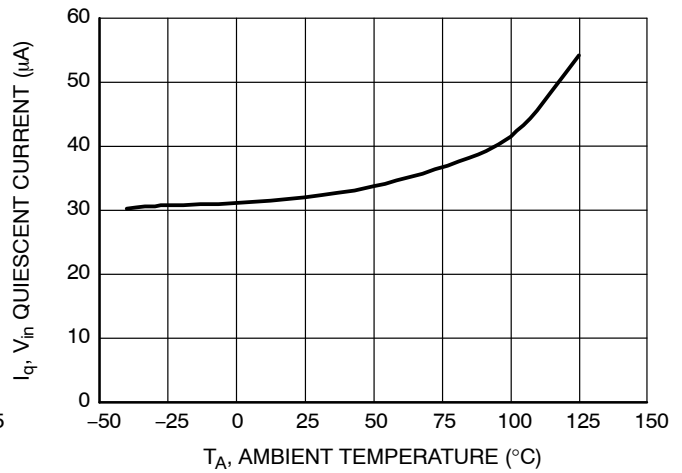

Figure 6. Quiescent Current vs. Temperature  
(EN = High, Open Loop, V<sub>OUT</sub> = 1.8 V,  
V<sub>IN</sub> = 3.6 V)

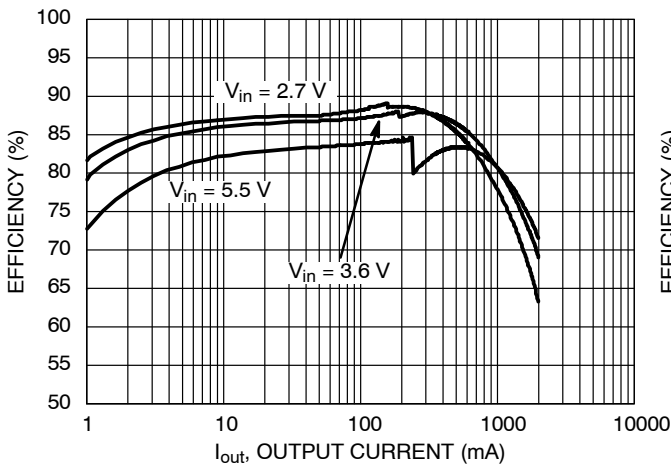

Figure 7. Efficiency vs. Output Current and  
Input Voltage (V<sub>OUT</sub> = 1.05 V, T<sub>A</sub> = 25°C)

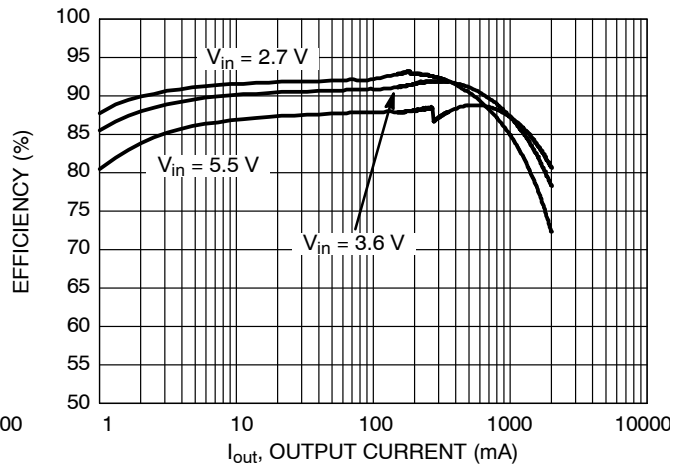

Figure 8. Efficiency vs. Output Current and  
Input Voltage (V<sub>OUT</sub> = 1.8 V, T<sub>A</sub> = 25°C)

TYPICAL OPERATING CHARACTERISTICS

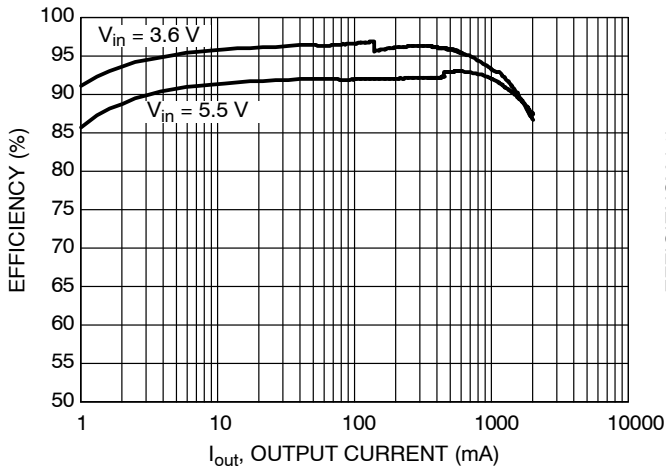

Figure 9. Efficiency vs. Output Current and Input Voltage ( $V_{OUT} = 3.3\text{ V}$ ,  $T_A = 25^\circ\text{C}$ )

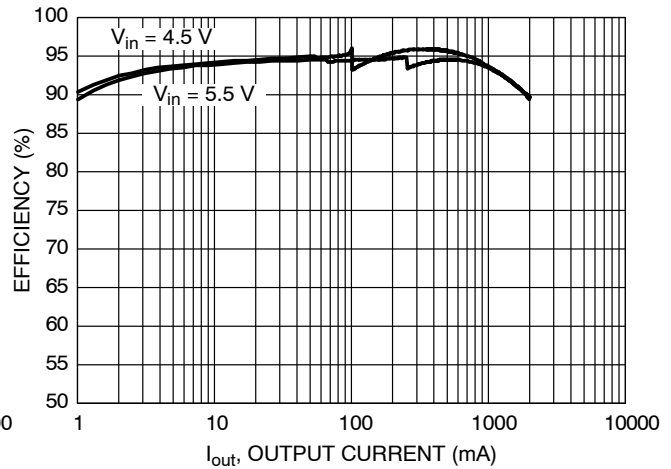

Figure 10. Efficiency vs. Output Current and Input Voltage ( $V_{OUT} = 4\text{ V}$ ,  $T_A = 25^\circ\text{C}$ )

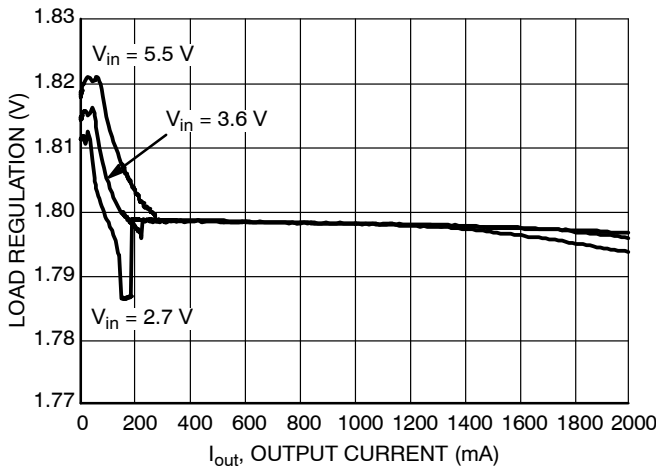

Figure 11. Load Regulation vs. Output Current and Input Voltage ( $V_{OUT} = 1.8\text{ V}$ ,  $T_A = 25^\circ\text{C}$ )

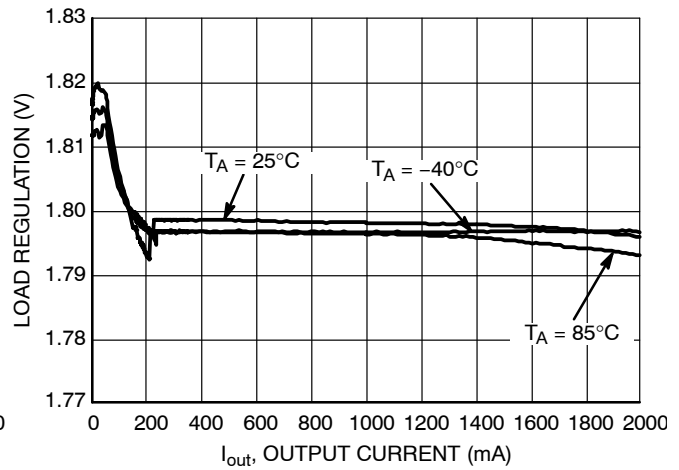

Figure 12. Load Regulation vs. Output Current and Temperature ( $V_{IN} = 3.6\text{ V}$ ,  $V_{OUT} = 1.8\text{ V}$ ).

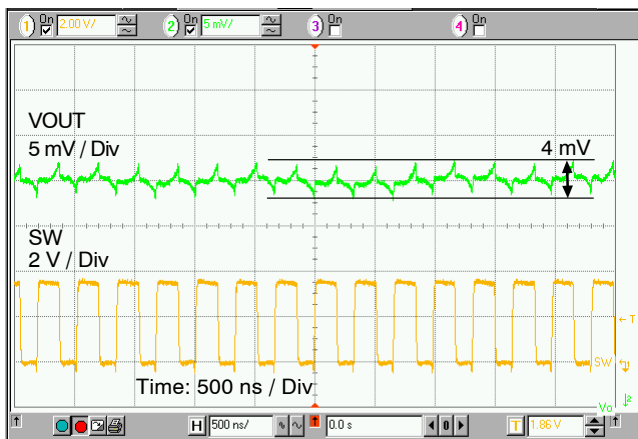

Figure 13. Output Ripple Voltage in PWM Mode ( $V_{IN} = 3.6\text{ V}$ ,  $V_{OUT} = 1.8\text{ V}$ ,  $I_{OUT} = 1\text{ A}$ ,  $L = 1\text{ }\mu\text{H}$ ,  $C_{OUT} = 10\text{ }\mu\text{F}$ )

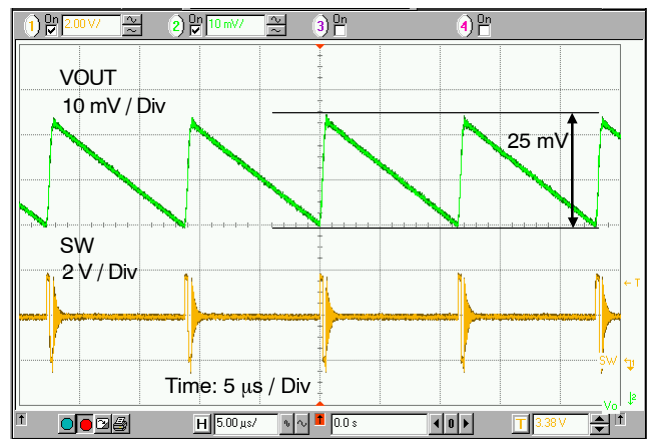

Figure 14. Output Ripple Voltage in PFM Mode ( $V_{IN} = 3.6\text{ V}$ ,  $V_{OUT} = 1.8\text{ V}$ ,  $I_{OUT} = 10\text{ mA}$ ,  $L = 1\text{ }\mu\text{H}$ ,  $C_{OUT} = 10\text{ }\mu\text{F}$ )

TYPICAL OPERATING CHARACTERISTICS

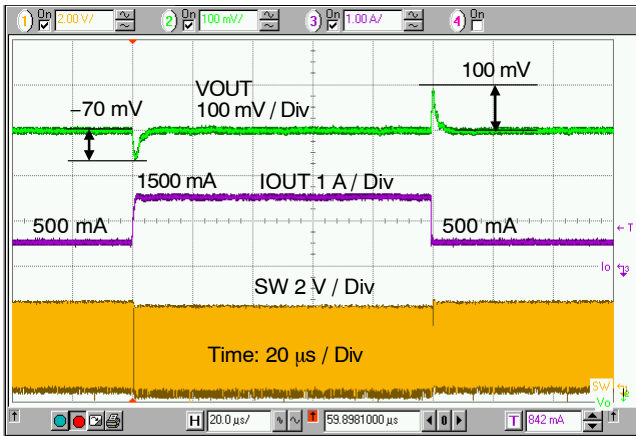

Figure 15. Load Transient Response ( $V_{IN} = 3.6\text{ V}$ ,  $V_{OUT} = 1.8\text{ V}$ ,  $I_{OUT} = 500\text{ mA}$  to  $1500\text{ mA}$ ,  $L = 1\text{ }\mu\text{H}$ ,  $C_{OUT} = 10\text{ }\mu\text{F}$ )

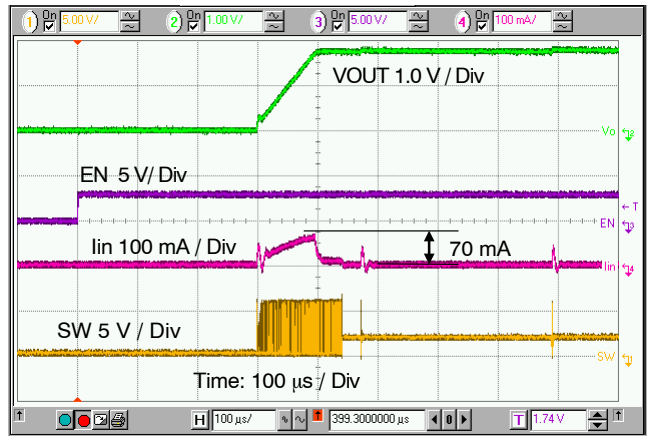

Figure 16. Power Up Sequence and Inrush Current in Input ( $V_{IN} = 3.6\text{ V}$ ,  $V_{OUT} = 1.8\text{ V}$ ,  $I_{OUT} = 0\text{ A}$ ,  $L = 1\text{ }\mu\text{H}$ ,  $C_{OUT} = 10\text{ }\mu\text{F}$ )

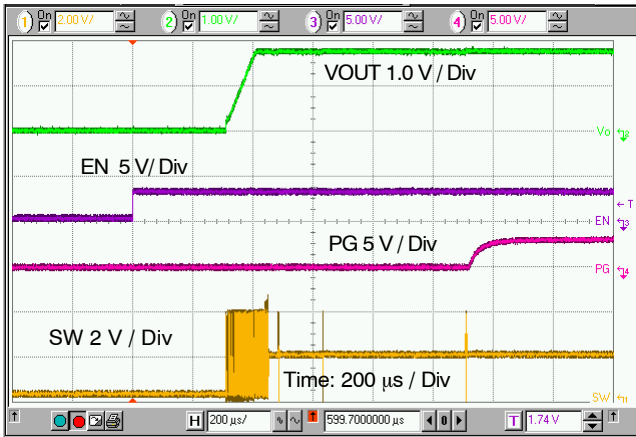

Figure 17. Power Up Sequence and Power Good ( $V_{IN} = 3.6\text{ V}$ ,  $V_{OUT} = 1.8\text{ V}$ ,  $I_{OUT} = 0\text{ A}$ ,  $L = 1\text{ }\mu\text{H}$ ,  $C_{OUT} = 10\text{ }\mu\text{F}$ )

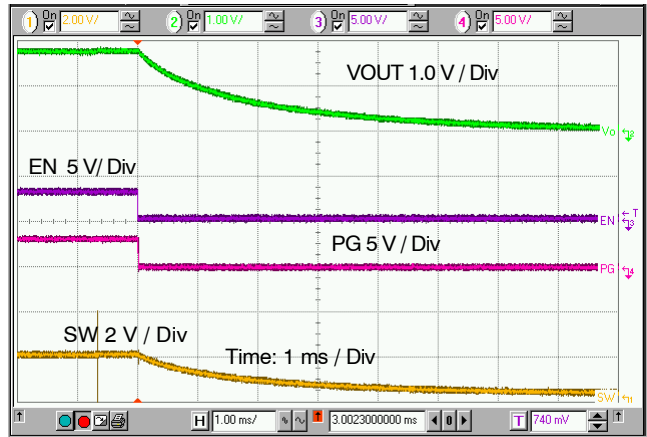

Figure 18. Power Down Sequence and Active Output Discharge ( $V_{IN} = 3.6\text{ V}$ ,  $V_{OUT} = 1.8\text{ V}$ ,  $I_{OUT} = 0\text{ A}$ ,  $L = 1\text{ }\mu\text{H}$ ,  $C_{OUT} = 10\text{ }\mu\text{F}$ )



DETAILED DESCRIPTION

**General**

The NCV6334B, a family of voltage-mode synchronous buck converters, which is optimized to supply different sub-systems of portable applications powered by one cell Li-ion or three cell Alkaline/NiCd/NiMH batteries. The devices are able to deliver up to 2 A on an external adjustable voltage. Operation with 3 MHz switching frequency allows employing small size inductor and capacitors. Input supply voltage feedforward control is employed to deal with wide input voltage range. Synchronous rectification and automatic PWM/PFM power save mode offer improved system efficiency.

**PWM Mode Operation**

In medium and heavy load range, the inductor current is continuous and the device operates in PWM mode with fixed switching frequency, which has a typical value of 3 MHz. In this mode, the output voltage is regulated by on-time pulse width modulation of an internal P-MOSFET. An internal N-MOSFET operates as synchronous rectifier and its turn-on signal is complimentary to that of the P-MOSFET.

**PFM Mode Operation**

In light load range, the inductor current becomes discontinuous and the device automatically operates in PFM mode with an adaptive fixed on time and variable switching

frequency. In this mode, the output voltage is regulated by pulse frequency modulation of the internal P-MOSFET, and the switching frequency is almost proportional to the loading current. The internal N-MOSFET operates as synchronous rectifier after each on pulse of the P-MOSFET with a very small negative current limit. When the load increases and the inductor current becomes continuous, the controller automatically turns back to the fixed-frequency PWM mode operation.

**Undervoltage Lockout**

The input voltage  $V_{IN}$  must reach or exceed 2.4 V (typical) before the NCV6334B enables the converter output to begin the start up sequence. The UVLO threshold hysteresis is typically 100 mV.

**Enable**

The NCV6334B has an enable logic input pin EN. A high level (above 1.1 V) on this pin enables the device to active mode. A low level (below 0.4 V) on this pin disables the device and makes the device in shutdown mode. There is an internal filter with 5  $\mu$ s time constant. The EN pin is pulled down by an internal 10 nA sink current source. In most of applications, the EN signal can be programmed independently to  $V_{IN}$  power sequence.

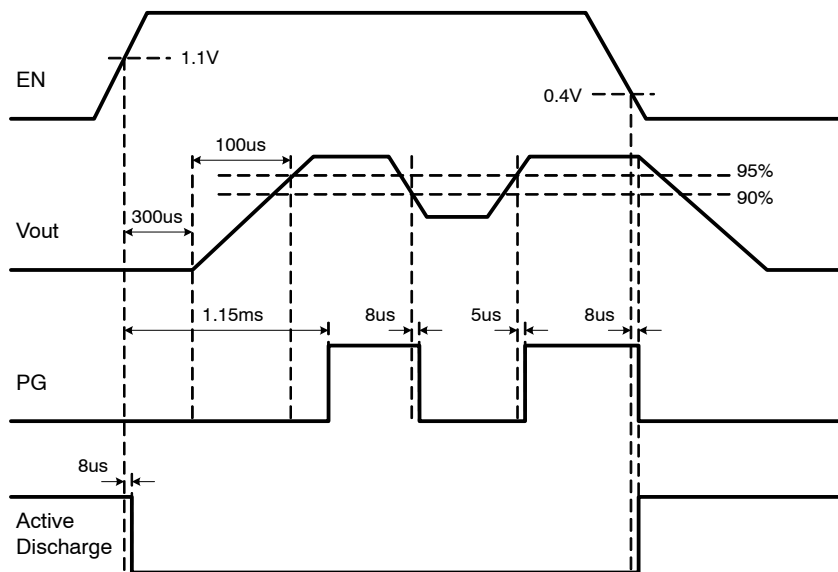

Figure 19. Power Good and Active Discharge Timing Diagram

## Power Good Output

For NCV6334B with a power good output, the device monitors the output voltage and provides a power good output signal at the PG pin. This pin is an open-drain output pin. To indicate the output of the converter is established, a power good signal is available. The power good signal is low when EN is high but the output voltage has not been established. Once the output voltage of the converter drops out below 90% of its regulation during operation, the power good signal is pulled low and indicates a power failure. A 5% hysteresis is required on power good comparator before signal going high again.

## Soft-Start

A soft start limits inrush current when the converter is enabled. After a minimum 300  $\mu$ s delay time following the enable signal, the output voltage starts to ramp up in 100  $\mu$ s (for external adjustable voltage devices) or with a typical 10 V/ms slew rate (for fixed voltage devices).

## Active Output Discharge

An output discharge operation is active in when EN is low. A discharge resistor (500  $\Omega$  typical) is enabled in this condition to discharge the output capacitor through SW pin.

## Cycle-by-Cycle Current Limitation

The NCV6334B protects the device from over current with a fixed-value cycle-by-cycle current limitation. The typical peak current limit  $I_{LMT}$  is 2.8 A. If inductor current exceeds the current limit threshold, the P-MOSFET will be turned off cycle-by-cycle. The maximum output current can be calculated by

$$I_{MAX} = I_{LMT} - \frac{V_{OUT} \cdot (V_{IN} - V_{OUT})}{2 \cdot V_{IN} \cdot f_{SW} \cdot L} \quad (\text{eq. 1})$$

where  $V_{IN}$  is input supply voltage,  $V_{OUT}$  is output voltage,  $L$  is inductance of the filter inductor, and  $f_{SW}$  is 3 MHz normal switching frequency.

## Thermal Shutdown

The NCV6334B has a thermal shutdown protection to protect the device from overheating when the die temperature exceeds 160°C. After the thermal protection is triggered, the fault state can be ended by re-applying  $V_{IN}$  and/or EN when the temperature drops down below 125°C.

APPLICATION INFORMATION

Output Filter Design Considerations

The output filter introduces a double pole in the system at a frequency of

$$f_{LC} = \frac{1}{2 \cdot \pi \cdot \sqrt{L \cdot C}} \quad (\text{eq. 2})$$

The internal compensation network design of the NCV6334B is optimized for the typical output filter comprised of a 1.0 μH inductor and a 10 μF ceramic output capacitor, which has a double pole frequency at about 50 kHz. Other possible output filter combinations may have a double pole around 50 kHz to have optimum operation with the typical feedback network. Normal selection range of the inductor is from 0.47 μH to 4.7 μH, and normal selection range of the output capacitor is from 4.7 μF to 22 μF.

Inductor Selection

The inductance of the inductor is determined by given peak-to-peak ripple current  $I_{L\_PP}$  of approximately 20%

to 50% of the maximum output current  $I_{OUT\_MAX}$  for a trade-off between transient response and output ripple. The inductance corresponding to the given current ripple is

$$L = \frac{(V_{IN} - V_{OUT}) \cdot V_{OUT}}{V_{IN} \cdot f_{SW} \cdot I_{L\_PP}} \quad (\text{eq. 3})$$

The selected inductor must have high enough saturation current rating to be higher than the maximum peak current that is

$$I_{L\_MAX} = I_{OUT\_MAX} + \frac{I_{L\_PP}}{2} \quad (\text{eq. 4})$$

The inductor also needs to have high enough current rating based on temperature rise concern. Low DCR is good for efficiency improvement and temperature rise reduction. Table 1 shows some recommended inductors for high power applications and Table 2 shows some recommended inductors for low power applications.

Table 1. LIST OF RECOMMENDED INDUCTORS FOR HIGH POWER APPLICATIONS

| Manufacturer | Part Number    | Case Size (mm)  | L (μH) | Rated Current (mA) (Inductance Drop) | Structure  |
|--------------|----------------|-----------------|--------|--------------------------------------|------------|
| MURATA       | LQH44PN2R2MP0  | 4.0 x 4.0 x 1.8 | 2.2    | 2500 (-30%)                          | Wire Wound |
| MURATA       | LQH44PN1R0NP0  | 4.0 x 4.0 x 1.8 | 1.0    | 2950 (-30%)                          | Wire Wound |
| MURATA       | LQH32PNR47NNP0 | 3.0 x 2.5 x 1.7 | 0.47   | 3400 (-30%)                          | Wire Wound |

Table 2. LIST OF RECOMMENDED INDUCTORS FOR LOW POWER APPLICATIONS

| Manufacturer | Part Number     | Case Size (mm)  | L (μH) | Rated Current (mA) (Inductance Drop) | Structure  |
|--------------|-----------------|-----------------|--------|--------------------------------------|------------|
| MURATA       | LQH44PN2R2MJ0   | 4.0 x 4.0 x 1.1 | 2.2    | 1320 (-30%)                          | Wire Wound |
| MURATA       | LQH44PN1R0NJ0   | 4.0 x 4.0 x 1.1 | 1.0    | 2000 (-30%)                          | Wire Wound |
| TDK          | VLS201612ET-2R2 | 2.0 x 1.6 x 1.2 | 2.2    | 1150 (-30%)                          | Wire Wound |
| TDK          | VLS201612ET-1R0 | 2.0 x 1.6 x 1.2 | 1.0    | 1650 (-30%)                          | Wire Wound |

Output Capacitor Selection

The output capacitor selection is determined by output voltage ripple and load transient response requirement. For a given peak-to-peak ripple current  $I_{L\_PP}$  in the inductor of the output filter, the output voltage ripple across the output capacitor is the sum of three ripple components as below.

$$V_{OUT\_PP} \approx V_{OUT\_PP(C)} + V_{OUT\_PP(ESR)} + V_{OUT\_PP(ESL)} \quad (\text{eq. 5})$$

where  $V_{OUT\_PP(C)}$  is a ripple component by an equivalent total capacitance of the output capacitors,  $V_{OUT\_PP(ESR)}$  is a ripple component by an equivalent ESR of the output capacitors, and  $V_{OUT\_PP(ESL)}$  is a ripple component by an equivalent ESL of the output capacitors. In PWM

operation mode, the three ripple components can be obtained by

$$V_{OUT\_PP(C)} = \frac{I_{L\_PP}}{8 \cdot C \cdot f_{SW}} \quad (\text{eq. 6})$$

$$V_{OUT\_PP(ESR)} = I_{L\_PP} \cdot ESR \quad (\text{eq. 7})$$

$$V_{OUT\_PP(ESL)} = \frac{ESL}{ESL + L} \cdot V_{IN} \quad (\text{eq. 8})$$

and the peak-to-peak ripple current is

$$I_{L\_PP} = \frac{(V_{IN} - V_{OUT}) \cdot V_{OUT}}{V_{IN} \cdot f_{SW} \cdot L} \quad (\text{eq. 9})$$

## NCV6334B

In applications with all ceramic output capacitors, the main ripple component of the output ripple is  $V_{OUT\_PP}(C)$ . So that the minimum output capacitance can be calculated regarding to a given output ripple requirement  $V_{OUT\_PP}$  in PWM operation mode.

$$C_{MIN} = \frac{I_{L\_PP}}{8 \cdot V_{OUT\_PP} \cdot f_{SW}} \quad (\text{eq. 10})$$

### Input Capacitor Selection

One of the input capacitor selection guides is the input voltage ripple requirement. To minimize the input voltage ripple and get better decoupling in the input power supply rail, ceramic capacitor is recommended due to low ESR and ESL. The minimum input capacitance regarding to the input ripple voltage  $V_{IN\_PP}$  is

$$C_{IN\_MIN} = \frac{I_{OUT\_MAX} \cdot (D - D^2)}{V_{IN\_PP} \cdot f_{SW}} \quad (\text{eq. 11})$$

where

$$D = \frac{V_{OUT}}{V_{IN}} \quad (\text{eq. 12})$$

In addition, the input capacitor needs to be able to absorb the input current, which has a RMS value of

$$I_{IN\_RMS} = I_{OUT\_MAX} \cdot \sqrt{D - D^2} \quad (\text{eq. 13})$$

The input capacitor also needs to be sufficient to protect the device from over voltage spike, and normally at least a 4.7  $\mu\text{F}$  capacitor is required. The input capacitor should be located as close as possible to the IC on PCB.

**Table 3. LIST OF RECOMMENDED INPUT CAPACITORS AND OUTPUT CAPACITORS**

| Manufacturer | Part Number            | Case Size | Height Max (mm) | C ( $\mu\text{F}$ ) | Rated Voltage (V) | Structure |
|--------------|------------------------|-----------|-----------------|---------------------|-------------------|-----------|
| MURATA       | GRM21BR60J226ME39, X5R | 0805      | 1.4             | 22                  | 6.3               | MLCC      |
| TDK          | C2012X5R0J226M, X5R    | 0805      | 1.25            | 22                  | 6.3               | MLCC      |
| MURATA       | GRM21BR61A106KE19, X5R | 0805      | 1.35            | 10                  | 10                | MLCC      |
| TDK          | C2012X5R1A106M, X5R    | 0805      | 1.25            | 10                  | 10                | MLCC      |
| MURATA       | GRM188R60J106ME47, X5R | 0603      | 0.9             | 10                  | 6.3               | MLCC      |
| TDK          | C1608X5R0J106M, X5R    | 0603      | 0.8             | 10                  | 6.3               | MLCC      |
| MURATA       | GRM188R60J475KE19, X5R | 0603      | 0.87            | 4.7                 | 6.3               | MLCC      |

### Design of Feedback Network

For NCV6334B devices with an external adjustable output voltage, the output voltage is programmed by an external resistor divider connected from  $V_{OUT}$  to FB and then to AGND, as shown in the typical application schematic Figure 1(a). The programmed output voltage is

$$V_{OUT} = V_{FB} \cdot \left(1 + \frac{R_1}{R_2}\right) \quad (\text{eq. 14})$$

where  $V_{FB}$  is equal to the internal reference voltage 0.6 V,  $R_1$  is the resistance from  $V_{OUT}$  to FB, which has a normal value range from 50 k $\Omega$  to 1 M $\Omega$  and a typical value of

220 k $\Omega$  for applications with the typical output filter.  $R_2$  is the resistance from FB to AGND, which is used to program the output voltage according to equation (14) once the value of  $R_1$  has been selected. A capacitor  $C_{fb}$  needs to be employed between the  $V_{OUT}$  and FB in order to provide feedforward function to achieve optimum transient response. Normal value range of  $C_{fb}$  is from 0 to 100 pF, and a typical value is 15 pF for applications with the typical output filter and  $R_1 = 220$  k $\Omega$ .

Table 4 provides reference values of  $R_1$  and  $C_{fb}$  in case of different output filter combinations. The final design may need to be fine tuned regarding to application specifications.

**Table 4. Reference Values of Feedback Networks ( $R_1$  and  $C_{fb}$ ) for Output Filter Combinations (L and C)**

| $R_1$ (k $\Omega$ ) |     | L ( $\mu\text{H}$ ) |      |     |     |     |     |
|---------------------|-----|---------------------|------|-----|-----|-----|-----|
| $C_{fb}$ (pF)       |     | 0.47                | 0.68 | 1   | 2.2 | 3.3 | 4.7 |
| C ( $\mu\text{F}$ ) | 4.7 | 220                 | 220  | 220 | 220 | 330 | 330 |
|                     |     | 3                   | 5    | 8   | 15  | 15  | 22  |
|                     | 10  | 220                 | 220  | 220 | 220 | 330 | 330 |
|                     |     | 8                   | 10   | 15  | 27  | 27  | 39  |
|                     | 22  | 220                 | 220  | 220 | 220 | 330 | 330 |
|                     |     | 15                  | 22   | 27  | 39  | 47  | 56  |

LAYOUT CONSIDERATIONS

**Electrical Layout Considerations**

Good electrical layout is a key to make sure proper operation, high efficiency, and noise reduction. Electrical layout guidelines are:

- Use wide and short traces for power paths (such as PVIN, VOUT, SW, and PGND) to reduce parasitic inductance and high-frequency loop area. It is also good for efficiency improvement.
- The device should be well decoupled by input capacitor and input loop area should be as small as possible to reduce parasitic inductance, input voltage spike, and noise emission.
- SW node should be a large copper pour, but compact because it is also a noise source.
- It would be good to have separated ground planes for PGND and AGND and connect the two planes at one point. Directly connect AGND pin to the exposed pad and then connect to AGND ground plane through vias. Try best to avoid overlap of input ground loop and output ground loop to prevent noise impact on output regulation.

- Arrange a “quiet” path for output voltage sense and feedback network, and make it surrounded by a ground plane.

**Thermal Layout Considerations**

Good thermal layout helps high power dissipation from a small package with reduced temperature rise. Thermal layout guidelines are:

- The exposed pad must be well soldered on the board.
- A four or more layers PCB board with solid ground planes is preferred for better heat dissipation.
- More free vias are welcome to be around IC and/or underneath the exposed pad to connect the inner ground layers to reduce thermal impedance.
- Use large area copper especially in top layer to help thermal conduction and radiation.
- Do not put the inductor to be too close to the IC, thus the heat sources are distributed.

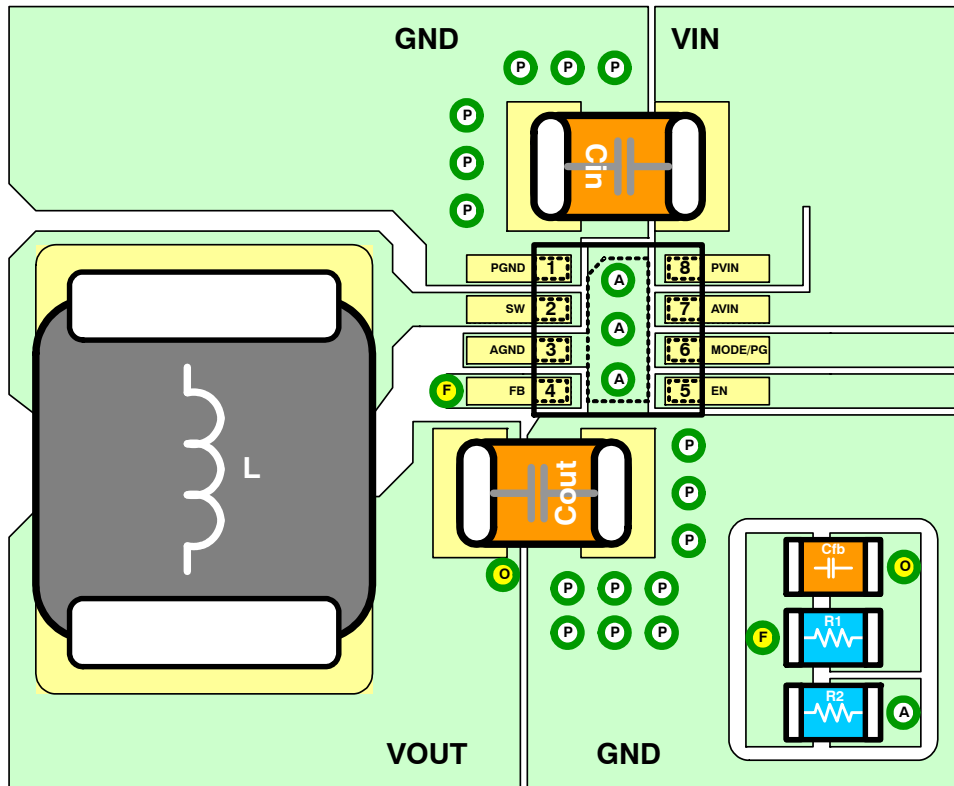
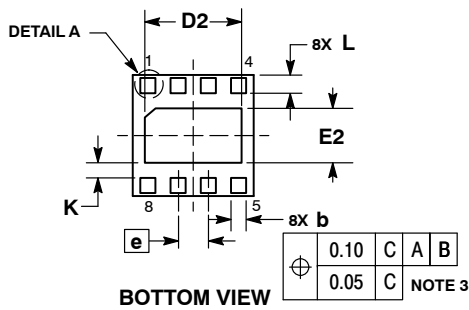
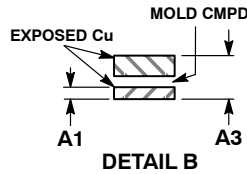
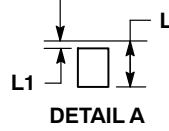
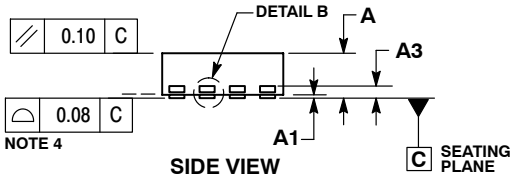
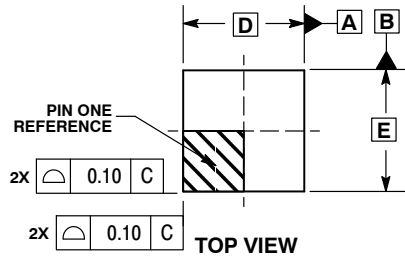

Figure 20. Recommended PCB Layout for Application Boards

# NCV6334B

## PACKAGE DIMENSIONS

WDFN8 2x2, 0.5P  
CASE 511BT  
ISSUE O



**NOTES:**

1. DIMENSIONING AND TOLERANCING PER ASME Y14.5M, 1994.
2. CONTROLLING DIMENSION: MILLIMETERS.
3. DIMENSION b APPLIES TO PLATED TERMINAL AND IS MEASURED BETWEEN 0.15 AND 0.30 MM FROM TERMINAL TIP.
4. COPLANARITY APPLIES TO THE EXPOSED PAD AS WELL AS THE TERMINALS.

| MILLIMETERS |          |      |
|-------------|----------|------|
| DIM         | MIN      | MAX  |
| A           | 0.70     | 0.80 |
| A1          | 0.00     | 0.05 |
| A3          | 0.20     | REF  |
| b           | 0.20     | 0.30 |
| D           | 2.00 BSC |      |
| D2          | 1.50     | 1.70 |
| E           | 2.00 BSC |      |
| E2          | 0.80     | 1.00 |
| e           | 0.50 BSC |      |
| K           | 0.25 REF |      |
| L           | 0.20     | 0.40 |
| L1          | ---      | 0.15 |

**RECOMMENDED SOLDERING FOOTPRINT\***

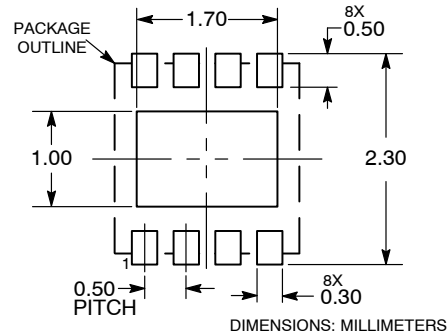

\*For additional information on our Pb-Free strategy and soldering details, please download the ON Semiconductor Soldering and Mounting Techniques Reference Manual, SOLDERRM/D.

ON Semiconductor and are registered trademarks of Semiconductor Components Industries, LLC (SCILLC). SCILLC owns the rights to a number of patents, trademarks, copyrights, trade secrets, and other intellectual property. A listing of SCILLC's product/patent coverage may be accessed at [www.onsemi.com/site/pdf/Patent-Marking.pdf](http://www.onsemi.com/site/pdf/Patent-Marking.pdf). SCILLC reserves the right to make changes without further notice to any products herein. SCILLC makes no warranty, representation or guarantee regarding the suitability of its products for any particular purpose, nor does SCILLC assume any liability arising out of the application or use of any product or circuit, and specifically disclaims any and all liability, including without limitation special, consequential or incidental damages. "Typical" parameters which may be provided in SCILLC data sheets and/or specifications can and do vary in different applications and actual performance may vary over time. All operating parameters, including "Typicals" must be validated for each customer application by customer's technical experts. SCILLC does not convey any license under its patent rights nor the rights of others. SCILLC products are not designed, intended, or authorized for use as components in systems intended for surgical implant into the body, or other applications intended to support or sustain life, or for any other application in which the failure of the SCILLC product could create a situation where personal injury or death may occur. Should Buyer purchase or use SCILLC products for any such unintended or unauthorized application, Buyer shall indemnify and hold SCILLC and its officers, employees, subsidiaries, affiliates, and distributors harmless against all claims, costs, damages, and expenses, and reasonable attorney fees arising out of, directly or indirectly, any claim of personal injury or death associated with such unintended or unauthorized use, even if such claim alleges that SCILLC was negligent regarding the design or manufacture of the part. SCILLC is an Equal Opportunity/Affirmative Action Employer. This literature is subject to all applicable copyright laws and is not for resale in any manner.

**PUBLICATION ORDERING INFORMATION**

**LITERATURE FULFILLMENT:**  
Literature Distribution Center for ON Semiconductor  
P.O. Box 5163, Denver, Colorado 80217 USA  
**Phone:** 303-675-2175 or 800-344-3860 Toll Free USA/Canada  
**Fax:** 303-675-2176 or 800-344-3867 Toll Free USA/Canada  
**Email:** [orderlit@onsemi.com](mailto:orderlit@onsemi.com)

**N. American Technical Support:** 800-282-9855 Toll Free USA/Canada  
**Europe, Middle East and Africa Technical Support:**  
Phone: 421 33 790 2910  
**Japan Customer Focus Center**  
Phone: 81-3-5817-1050

**ON Semiconductor Website:** [www.onsemi.com](http://www.onsemi.com)  
**Order Literature:** <http://www.onsemi.com/orderlit>  
For additional information, please contact your local Sales Representative