

Automotive Grade Start-Stop Non-Synchronous Boost Controller

NCV8877

The NCV8877 is a Non-Synchronous Boost controller designed to supply a minimum output voltage during Start-Stop vehicle operation battery voltage sags. The controller drives an external N-channel MOSFET. The device uses peak current mode control with internal slope compensation. The IC incorporates an internal regulator that supplies charge to the gate driver.

Protection features include, cycle-by-cycle current limiting and thermal shutdown.

Additional features include low quiescent current sleep mode operation. The NCV8877 is enabled when the supply voltage drops below the wake up threshold. Boost Operation is initiated when the supply voltage drops below the regulation set point.

Features

- Automatic Enable Below Wake Up Threshold Voltage (Factory Programmable)
- Override Disable Function
- Boost Mode Operation at Regulation Set Point
- $\pm 2\%$ Output Accuracy Over Temperature Range
- Peak Current Mode Control with Internal Slope Compensation
- Externally Adjustable Frequency Operation
- Wide Input Voltage Range of 2 V to 40 V, 45 V Load Dump
- Low Quiescent Current in Sleep Mode ($<12 \mu\text{A}$ Typical)
- Cycle-by-Cycle Current Limit Protection
- Hiccup-Mode Overcurrent Protection (OCP)
- Thermal Shutdown (TSD)
- This is a Pb-Free Device
- NCV Prefix for Automotive and Other Applications Requiring Unique Site and Control Change Requirements; AEC-Q100

Typical Applications

- Applications Requiring Regulated Voltage through Cranking and Start-Stop Operation



ON Semiconductor®

www.onsemi.com



SOIC-8
D SUFFIX
CASE 751
STYLE N/A

MARKING DIAGRAM

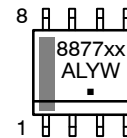

8877xx = Specific Device Code
xx = 00, 01, 11, 20, 40
A = Assembly Location
L = Wafer Lot
Y = Year
W = Work Week
▪ = Pb-Free Package

PIN CONNECTIONS

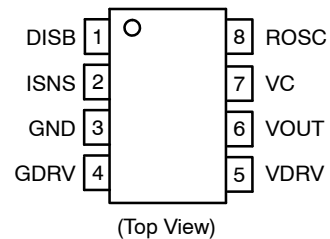

ORDERING INFORMATION

Device	Package	Shipping†
NCV887700D1R2G	SOIC-8 (Pb-Free)	2500 / Tape & Reel
NCV887701D1R2G		
NCV887711D1R2G		
NCV887720D1R2G		
NCV887740D1R2G		

†For information on tape and reel specifications, including part orientation and tape sizes, please refer to our Tape and Reel Packaging Specification Brochure, BRD8011/D.

NCV8877

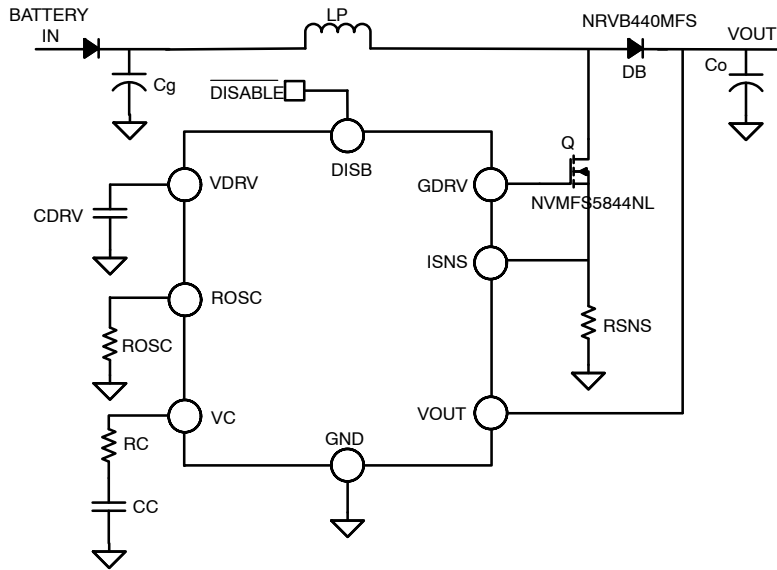

Figure 1. Typical Application

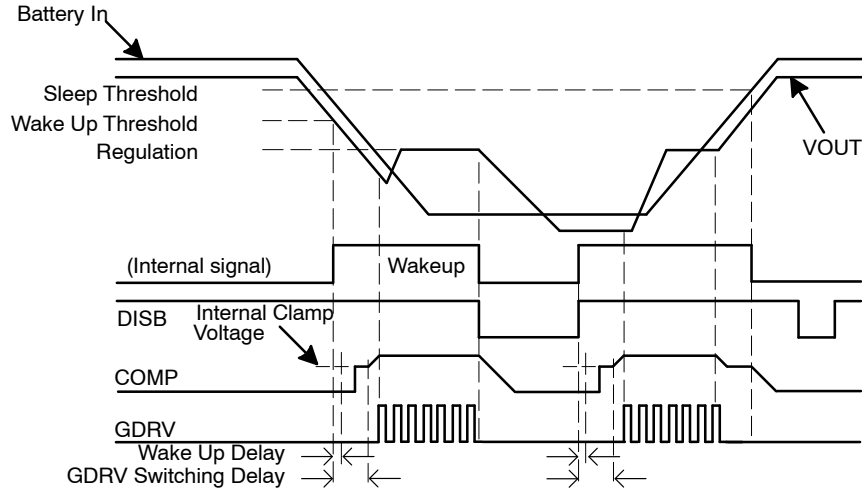

Figure 2. Functional Waveforms

PACKAGE PIN DESCRIPTIONS

Pin No.	Pin Symbol	Function
1	DISB	Disable input. This part is disabled when this pin is brought low.
2	ISNS	Current sense input. Connect this pin to the source of the external N-MOSFET, through a current-sense resistor to ground to sense the switching current for regulation and current limiting.
3	GND	Ground reference.
4	GDRV	Gate driver output. Connect to gate of the external N-MOSFET. A series resistance can be added from GDRV to the gate to tailor EMC performance.
5	VDRV	Driving voltage. Internally-regulated supply for driving the external N-MOSFET, sourced from VOUT. Bypass with a 1.0 μ F ceramic capacitor to ground.
6	VOUT	Monitors output voltage and provides IC input voltage.
7	VC	Output of the voltage error transconductance amplifier. An external compensator network from VC to GND is used to stabilize the converter.
8	ROSC	Use a resistor to ground to set the frequency.

NCV8877

ABSOLUTE MAXIMUM RATINGS (Voltages are with respect to GND, unless otherwise indicated)

Rating	Value	Unit
Dc Supply Voltage (VOUT)	-0.3 to 40	V
Peak Transient Voltage (Load Dump on VOUT)	45	V
Dc Supply Voltage (VDRV, GDRV)	12	V
Dc Voltage (VC, ISNS, ROSC)	-0.3 to 3.6	V
Dc Voltage (DISB)	-0.3 to 6	V
Dc Voltage Stress (VOUT - VDRV)	-0.7 to 40	V
Operating Junction Temperature	-40 to 150	°C
Storage Temperature Range	-65 to 150	°C
Peak Reflow Soldering Temperature: Pb-Free, 60 to 150 seconds at 217°C	265 peak	°C

Stresses exceeding those listed in the Maximum Ratings table may damage the device. If any of these limits are exceeded, device functionality should not be assumed, damage may occur and reliability may be affected.

PACKAGE CAPABILITIES

Characteristic	Value	Unit	
ESD Capability (All Pins)	Human Body Model Machine Model	≥2.0 ≥200	kV V
Moisture Sensitivity Level	1		
Package Thermal Resistance	Junction-to-Ambient, R _{θJA} (Note 1)	100	°C/W

1. 1 in², 1 oz copper area used for heatsinking.

TYPICAL VALUES

Part No.	D _{max}	f _s	S _a	V _{cl}	I _{src}	I _{sink}	VOUT	SCE
NCV887700	83%	170 kHz	34 mV/μs	400 mV	800 mA	600 mA	6.8 V	N
NCV887701	83%	170 kHz	53 mV/μs	200 mV	800 mA	600 mA	6.8 V	N
NCV887711	83%	170 kHz	53 mV/μs	200 mV	800 mA	600 mA	8.55 V	N
NCV887720	83%	170 kHz	53 mV/μs	200 mV	800 mA	600 mA	10 V	N
NCV887740	83%	170 kHz	53 mV/μs	200 mV	800 mA	600 mA	12 V	N

NCV8877

ELECTRICAL CHARACTERISTICS

($-40^{\circ}\text{C} < T_J < 150^{\circ}\text{C}$, $3.6\text{ V} < V_{\text{OUT}} < 40\text{ V}$, unless otherwise specified) Min/Max values are guaranteed by test, design or statistical correlation.

Characteristic	Symbol	Conditions	Min	Typ	Max	Unit
----------------	--------	------------	-----	-----	-----	------

GENERAL

Quiescent Current, Sleep Mode	$I_{q,\text{sleep}}$	$V_{\text{OUT}} = 13.2\text{ V}$, $T_J = 25^{\circ}\text{C}$, DISB = 0 V	–	12	14	μA
Quiescent Current, No switching	$I_{q,\text{off}}$	Into V_{OUT} pin, $V_{\text{OUT,reg}} < V_{\text{OUT}} < V_{\text{OUT,des}}$, No switching	–	2.2	4.0	mA

OSCILLATOR

Switching Frequency	F_{SW}		153	–	501	kHz	
R_{OSC} Voltage	V_{ROSC}		–	1.0	–	V	
Switching Frequency	F_{SW}	ROSC = Open	153	170	187	kHz	
Default Switching	F_{SW}	ROSC = Open ROSC = 100 k Ω ROSC = 20 k Ω ROSC = 10 k Ω	153 180 283 409	170 200 315 455	187 220 347 501	kHz	
Minimum Pulse Width	$t_{\text{on,min}}$		NCV887700 NCV887701 NCV887711 NCV887720 NCV887740	90 90 89 90 90	115 115 115 115 115	145 145 146 145 145	ns
Maximum Duty Cycle	D_{max}	ROSC = Open	NCV887700 NCV887701 NCV887711 NCV887720 NCV887740	81 81 81 81 81	83 83 83 83 83	85 85 85 85 85	%
Slope Compensating Ramp (Note 2)	S_a		NCV887700 NCV887701 NCV887711 NCV887720 NCV887740	30 46 45 46 46	34 53 53 53 53	38 60 61 60 60	mV/ μs

DISABLE

DISB Pull-down Current (Note 2)	I_{DIS}	$V_{\text{DIS}} = 5\text{ V}$	–	0.6	1.0	μA
DISB Input High Voltage	$V_{\text{d,ih}}$		2.0	–	5.0	V
DISB Input High Voltage Hysteresis	$V_{\text{d,hys}}$		–	500	–	mV
DISB Input Low Voltage	$V_{\text{d,il}}$		0	–	800	mV

CURRENT SENSE AMPLIFIER

Low-Frequency Gain	A_{csa}	Input-to-output gain at dc, $I_{\text{SNS}} \leq 1\text{ V}$	0.9	1.0	1.1	V/V	
Bandwidth	BW_{csa}	Gain of $A_{\text{csa}} - 3\text{ dB}$	2.5	–	–	MHz	
ISNS Input Bias Current	$I_{\text{sns,bias}}$	Out of ISNS pin	–	30	50	μA	
Current Limit Threshold Voltage	V_{cl}	Voltage on ISNS pin	NCV887700 NCV887701 NCV887711 NCV887720 NCV887740	360 180 180 180 180	400 200 200 200 200	440 220 220 220 220	mV
Current Limit, Response Time (Note 2)	t_{cl}	CL tripped until GDRV falling edge, $V_{\text{ISNS}} = V_{\text{cl}}(\text{typ}) + 60\text{ mV}$	–	80	125	ns	
Overcurrent Protection, Threshold Voltage	$\%V_{\text{ocp}}$	Percent of V_{cl}	125	150	175	%	
Overcurrent Protection, Response Time (Note 2)	t_{ocp}	From overcurrent event, Until switching stops, $V_{\text{ISNS}} = V_{\text{OCP}} + 40\text{ mV}$	–	80	125	ns	

Product parametric performance is indicated in the Electrical Characteristics for the listed test conditions, unless otherwise noted. Product performance may not be indicated by the Electrical Characteristics if operated under different conditions.

2. Not tested in production. Limits are guaranteed by design.

NCV8877

ELECTRICAL CHARACTERISTICS (continued)

($-40^{\circ}\text{C} < T_J < 150^{\circ}\text{C}$, $3.6\text{ V} < V_{\text{OUT}} < 40\text{ V}$, unless otherwise specified) Min/Max values are guaranteed by test, design or statistical correlation.

Characteristic	Symbol	Conditions	Min	Typ	Max	Unit
VOLTAGE ERROR OPERATIONAL TRANSCONDUCTANCE AMPLIFIER						
Transconductance	$g_{m,vea}$	$V_{\text{OUT}} = \pm 100\text{ mV}$	0.8	1.2	1.63	mS
VEA Output Resistance (Note 2)	$R_{o,vea}$		2.0	–	–	$\text{M}\Omega$
VEA Maximum Output Voltage	$V_{c,max}$		2.5	–	–	V
VEA Sourcing Current	$I_{src,vea}$	VEA output current, $V_c = 2.0\text{ V}$	80	100	–	μA
VEA Sinking Current	$I_{snk,vea}$	VEA output current, $V_c = 1.5\text{ V}$	80	100	–	μA
VEA Clamp Voltage	$V_{c,clamp}$	$V_{\text{OUT}} < V_{\text{OUT},des}$	–	1.1	–	V
GDRV Switching Delay		$V_{\text{OUT}} < V_{\text{OUT},des}$ or when IC DISB goes from low to high with V_c pin compensation network disconnected	–	55	64	μs

GATE DRIVER

Sourcing Current	I_{src}	$V_{\text{DRV}} \geq$ Typical Driving Voltage Specification, $V_{\text{DRV}} - V_{\text{GDRV}} = 2\text{ V}$	550	800	–	mA
Sinking Current	I_{sink}	$V_{\text{GDRV}} \geq 2\text{ V}$	480	600	–	mA
Driving Voltage Dropout (Note 2)	$V_{drv,do}$	$V_{\text{OUT}} - V_{\text{DRV}}$, $I_{\text{DRV}} = 25\text{ mA}$	–	0.3	0.6	V
Driving Voltage Source Current	I_{drv}	$V_{\text{OUT}} - V_{\text{DRV}} = 1\text{ V}$	35	45	–	mA
Backdrive Diode Voltage Drop	$V_{d,bd}$	$V_{\text{DRV}} - V_{\text{OUT}}$, $I_{d,bd} = 5\text{ mA}$	–	–	0.7	V
Driving Voltage	V_{DRV}	$I_{\text{DRV}} = 0.1 - 25\text{ mA}$	NCV887700 5.8 NCV887701 5.8 NCV887711 5.67 NCV887720 5.8 NCV887740 5.8	6.0 6.0 5.9 6.0 6.0	6.2 6.2 6.13 6.2 6.2	V
Pull-down Resistance			–	21	–	$\text{k}\Omega$

UVLO

Undervoltage Lock-out, Threshold Voltage	V_{uvlo}	V_{OUT} falling	NCV887700 3.60 NCV887701 3.60 NCV887711 3.54 NCV887720 3.60 NCV887740 3.60	3.80 3.80 3.73 3.80 3.80	4.00 4.00 4.00 4.00 4.00	V
Undervoltage Lock-out, Hysteresis	$V_{uvlo,hys}$	V_{OUT} rising	NCV887700 330 NCV887701 330 NCV887711 325 NCV887720 330 NCV887740 330	450 450 442 450 450	570 570 563 570 570	mV

THERMAL SHUTDOWN

Thermal Shutdown Threshold (Note 2)	T_{sd}	T_J rising	160	170	180	$^{\circ}\text{C}$
Thermal Shutdown Hysteresis (Note 2)	$T_{sd,hys}$	T_J falling	10	15	20	$^{\circ}\text{C}$
Thermal Shutdown Delay (Note 2)	$t_{sd,dly}$	From $T_J > T_{sd}$ to stop switching	–	–	100	ns

VOLTAGE REGULATION

Voltage Regulation	$V_{\text{OUT},reg}$		NCV887700 6.66 NCV887701 6.66 NCV887711 8.06 NCV887720 9.80 NCV887740 11.76	6.80 6.80 8.55 10.00 12.00	6.94 6.94 8.72 10.20 12.24	V
--------------------	----------------------	--	--	--	--	---

Product parametric performance is indicated in the Electrical Characteristics for the listed test conditions, unless otherwise noted. Product performance may not be indicated by the Electrical Characteristics if operated under different conditions.

2. Not tested in production. Limits are guaranteed by design.

NCV8877

ELECTRICAL CHARACTERISTICS (continued)

($-40^{\circ}\text{C} < T_J < 150^{\circ}\text{C}$, $3.6\text{ V} < V_{\text{OUT}} < 40\text{ V}$, unless otherwise specified) Min/Max values are guaranteed by test, design or statistical correlation.

Characteristic	Symbol	Conditions	Min	Typ	Max	Unit	
VOLTAGE REGULATION							
Threshold IC Enable		V_{OUT} descending	NCV887700	7.10	7.30	7.50	V
			NCV887701	7.10	7.30	7.50	
			NCV887711	8.82	9.11	9.39	
			NCV887720	10.36	10.65	10.94	
			NCV887740	12.64	13.00	13.36	
Threshold IC Disable		V_{OUT} ascending	NCV887700	7.55	7.75	7.95	V
			NCV887701	7.55	7.75	7.95	
			NCV887711	9.33	9.62	9.91	
			NCV887720	10.96	11.25	11.54	
			NCV887740	13.40	13.75	14.10	
Threshold IC Enable – Voltage Regulation			NCV887700	0.32	0.5	–	V
			NCV887701	0.32	0.5	–	
			NCV887711	0.33	0.5	–	
			NCV887720	0.39	0.6	–	
			NCV887740	0.52	0.8	–	
Threshold IC Disable – Threshold IC Enable			NCV887700	–	0.4	–	V
			NCV887701	–	0.4	–	
			NCV887711	–	0.4	–	
			NCV887720	–	0.5	–	
			NCV887740	–	0.7	–	

Product parametric performance is indicated in the Electrical Characteristics for the listed test conditions, unless otherwise noted. Product performance may not be indicated by the Electrical Characteristics if operated under different conditions.

2. Not tested in production. Limits are guaranteed by design.

TYPICAL CHARACTERISTICS

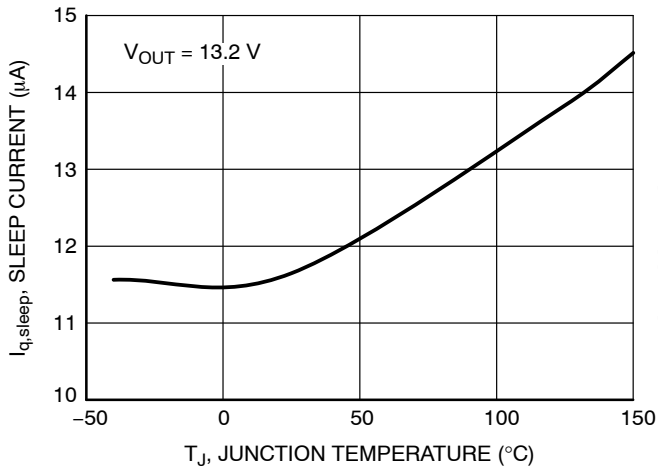

Figure 3. Sleep Current vs. Temperature

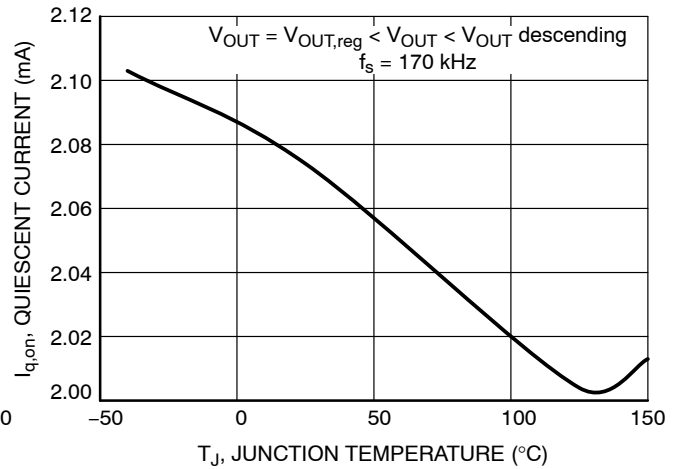

Figure 4. Quiescent Current vs. Temperature

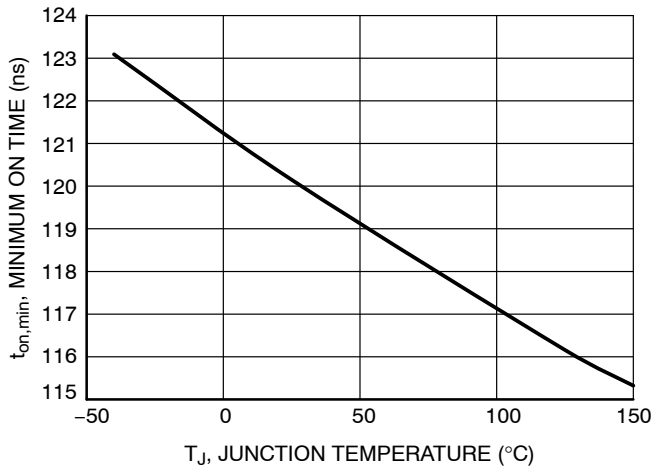

Figure 5. Minimum On Time vs. Temperature

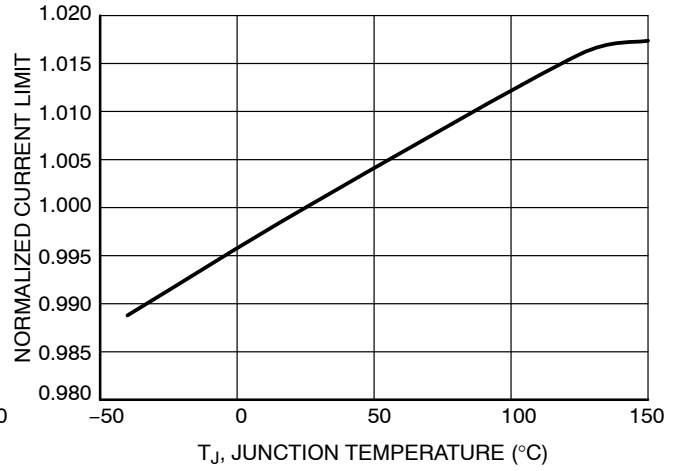

Figure 6. Normalized Current vs. Temperature

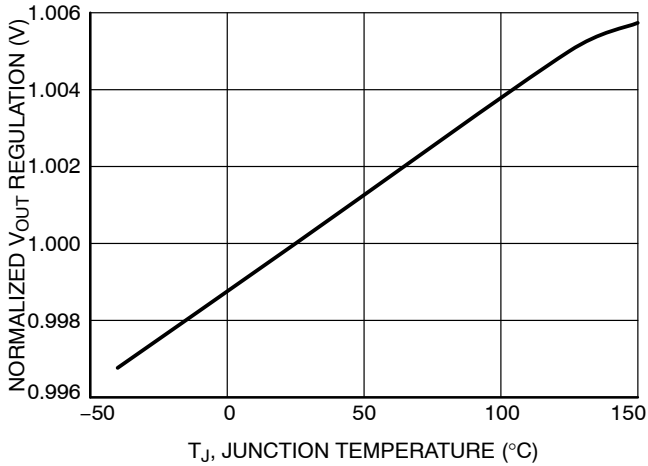

Figure 7. VOUT Regulation vs. Temperature

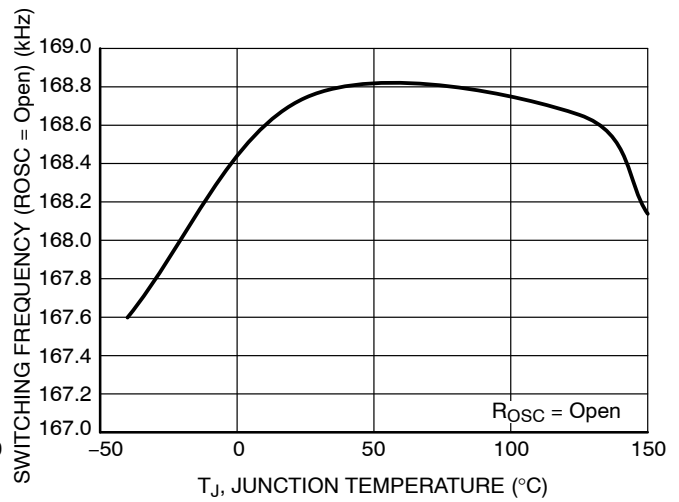

Figure 8. Switching Frequency vs. Temperature

TYPICAL CHARACTERISTICS (continued)

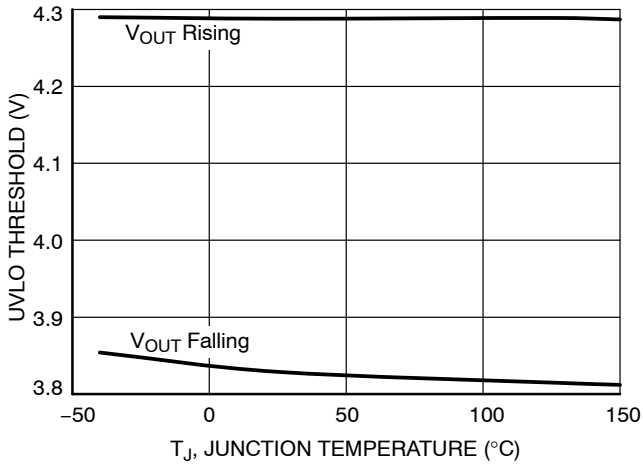

Figure 9. UVLO Threshold vs. Temperature

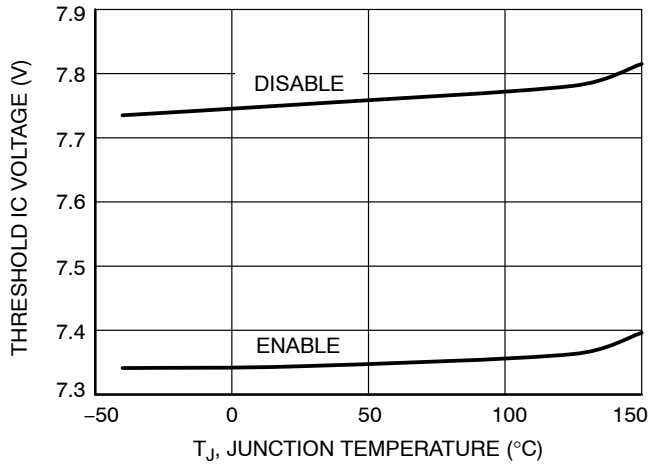

Figure 10. NCV887700/01 Threshold IC Voltage vs. Temperature

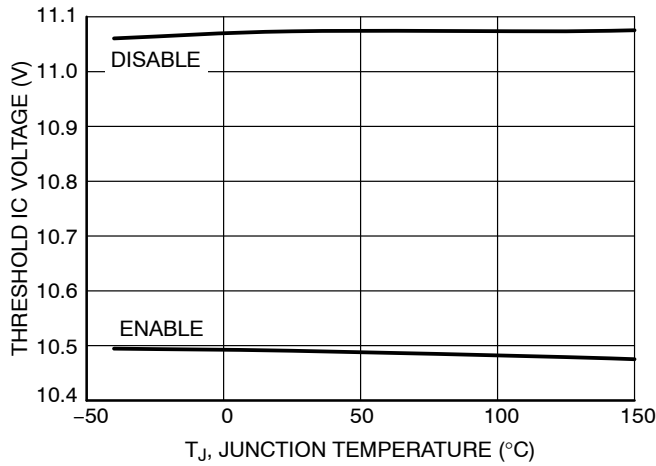

Figure 11. NCV887711 Threshold IC Voltage vs. Temperature

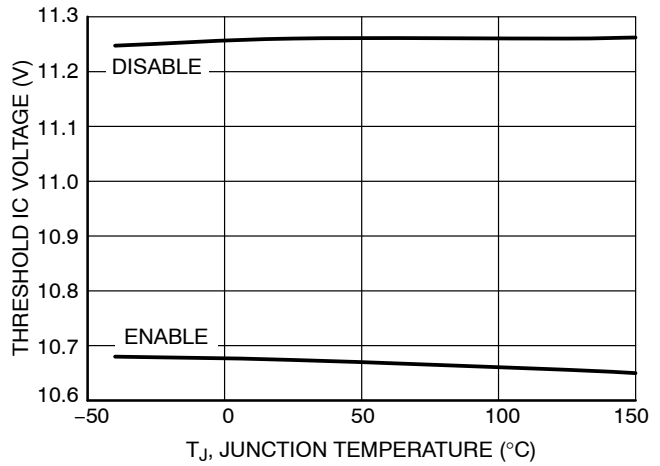

Figure 12. NCV887720 Threshold IC Voltage vs. Temperature

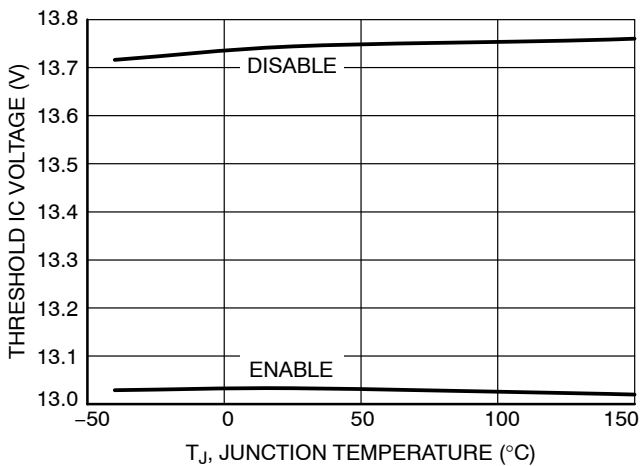

Figure 13. NCV887740 Threshold IC Voltage vs. Temperature

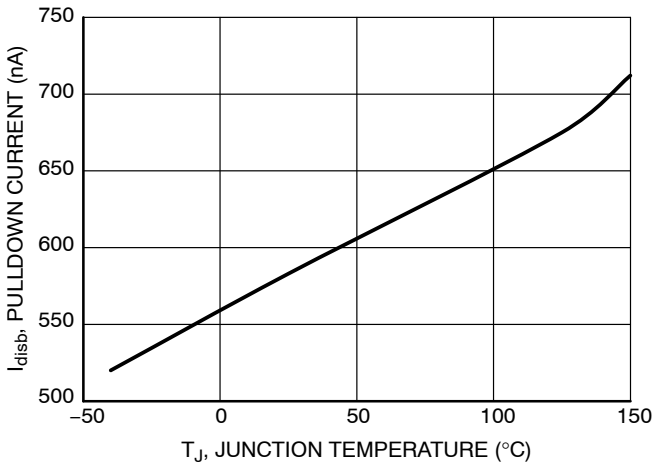

Figure 14. DISB Pulldown Current vs. Temperature

If the voltage across the current sense resistor exceeds the over current threshold voltage the device enters over current hiccup mode. The device will remain off for the hiccup time and then go through the soft-start procedure.

UVLO

Input Undervoltage Lockout (UVLO) is provided to ensure that unexpected behavior does not occur when VIN is too low to support the internal rails and power the controller. The IC will start up when enabled and VIN surpasses the UVLO threshold plus the UVLO hysteresis and will shut down when VIN drops below the UVLO threshold or the part is disabled.

VDRV

An internal regulator provides the drive voltage for the gate driver. Bypass with a ceramic capacitor to ground to ensure fast turn on times. The capacitor should be between 0.1 μF and 1 μF, depending on switching speed and charge requirements of the external MOSFET.

VDRV uses an internal linear regulator to charge the VDRV bypass capacitor. VOUT must be decoupled at the IC by a capacitor that is equal or larger in value than the VDRV decoupling capacitor.

APPLICATION INFORMATION

Design Methodology

This section details an overview of the component selection process for the NCV8877 in continuous conduction mode boost. It is intended to assist with the design process but does not remove all engineering design work. Many of the equations make heavy use of the small ripple approximation. This process entails the following steps:

1. Define Operational Parameters
2. Select Operating Frequency
3. Select Current Sense Resistor
4. Select Output Inductor
5. Select Output Capacitors
6. Select Input Capacitors
7. Select Compensator Components
8. Select MOSFET(s)
9. Select Diode
10. Design Notes
11. Determine Feedback Loop Compensation Network

1. Define Operational Parameters

Before beginning the design, define the operating parameters of the application. These include:

- V_{IN(min)}: minimum input voltage [V]
- V_{IN(max)}: maximum input voltage [V]
- V_{OUT}: output voltage [V]
- I_{OUT(max)}: maximum output current [A]
- I_{CL}: desired typical cycle-by-cycle current limit [A]

From this the ideal minimum and maximum duty cycles can be calculated as follows:

$$D_{min} = 1 - \frac{V_{IN(max)}}{V_{OUT}}$$

$$D_{max} = 1 - \frac{V_{IN(min)}}{V_{OUT}}$$

Both duty cycles will actually be higher due to power loss in the conversion. The exact duty cycles will depend on conduction and switching losses. If the maximum input voltage is higher than the output voltage, the minimum duty cycle will be negative. This is because a boost converter cannot have an output lower than the input. In situations where the input is higher than the output, the output will follow the input, minus the diode drop of the output diode and the converter will not attempt to switch.

If the calculated D_{max} is higher the D_{max} of the NCV8877, the conversion will not be possible. It is important for a boost converter to have a restricted D_{max}, because while the ideal conversion ration of a boost converter goes up to infinity as D approaches 1, a real converter’s conversion ratio starts to decrease as losses overtake the increased power transfer. If the converter is in this range it will not be able to regulate properly.

If the following equation is not satisfied, the device will skip pulses at high V_{IN}:

$$\frac{D_{min}}{f_s} \geq t_{on(min)}$$

Where: f_s: switching frequency [Hz]

t_{on(min)}: minimum on time [s]

2. Select Operating Frequency

The default setting is an open ROSC pin, allowing the oscillator to operate at the default frequency F_s. Adding a resistor to GND increases the switching frequency.

The graph in Figure 16, below, shows the required resistance to program the frequency. From 200 kHz to 500 kHz, the following formula is accurate to within 3% of the expected

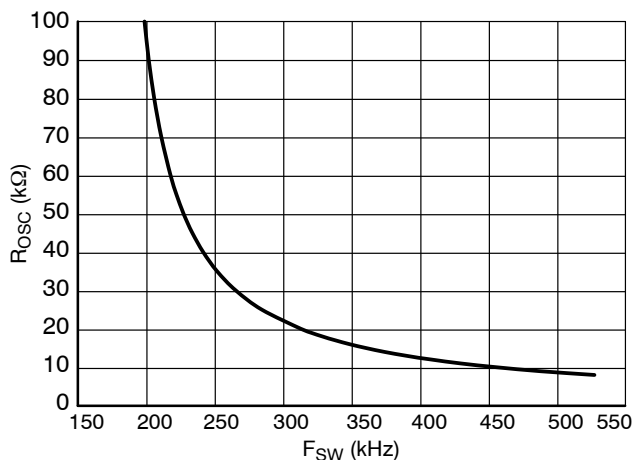

Figure 16. R_{osc} vs. F_{sw}

$$R_{OSC} = \frac{2859}{(f_{sw} - 170)}$$

Where: f_{sw} : switching frequency [kHz]

R_{OSC} : resistor from ROSC pin to GND [k]

Note: The R_{OSC} resistor ground return to the NCV8877 pin 3 must be independent of power grounds.

3. Select Current Sense Resistor

Current sensing for peak current mode control and current limit relies on the MOSFET current signal, which is measured with a ground referenced amplifier. The easiest method of generating this signal is to use a current sense resistor from the source of the MOSFET to device ground. The sense resistor should be selected as follows:

$$R_S = \frac{V_{CL}}{I_{CL}}$$

Where: R_S : sense resistor [Ω]

V_{CL} : current limit threshold voltage [V]

I_{CL} : desire current limit [A]

4. Select Output Inductor

The output inductor controls the current ripple that occurs over a switching period. A high current ripple will result in excessive power loss and ripple current requirements. A low current ripple will result in a poor control signal and a slow current slew rate in case of load steps. A good starting point for peak to peak ripple is around 20–40% of the inductor current at the maximum load at the worst case V_{IN} , but operation should be verified empirically. The worst case V_{IN} is half of V_{OUT} , or whatever V_{IN} is closest to half of V_{OUT} . After choosing a peak current ripple value, calculate the inductor value as follows:

$$L = \frac{V_{IN(WC)} D_{WC}}{\Delta I_{L,max} f_s}$$

Where: $V_{IN(WC)}$: V_{IN} value as close as possible to half of V_{OUT} [V]

D_{WC} : duty cycle at $V_{IN(WC)}$

$\Delta I_{L,max}$: maximum peak to peak ripple [A]

The maximum average inductor current can be calculated as follows:

$$I_{L,AVG} = \frac{V_{OUT} I_{OUT(max)}}{V_{IN(min)}}^1$$

The Peak Inductor current can be calculated as follows:

$$I_{L,peak} = I_{L,avg} + \frac{\Delta I_{L,max}}{2}$$

Where: $I_{L,peak}$: Peak inductor current value [A]

5. Select Output Capacitors

The output capacitors smooth the output voltage and reduce the overshoot and undershoot associated with line transients. The steady state output ripple associated with the output capacitors can be calculated as follows:

$$V_{OUT(ripple)} = \frac{D I_{OUT(max)}}{f C_{OUT}} + \left(\frac{I_{OUT(max)}}{1-D} + \frac{V_{IN(min)} D}{2fL} \right) R_{ESR}$$

The capacitors need to survive an RMS ripple current as follows:

$$I_{Cout(RMS)} = I_{OUT} \sqrt{\frac{D_{WC}}{D'_{WC}} + \frac{D_{WC}}{12} \left(\frac{D'_{WC}}{R_{OUT} \times T_{SW}} \right)^2}$$

The use of parallel ceramic bypass capacitors is strongly encouraged to help with the transient response.

6. Select Input Capacitors

The input capacitor reduces voltage ripple on the input to the module associated with the ac component of the input current.

$$I_{Cin(RMS)} = \frac{V_{IN(WC)}^2 D_{WC}}{L f_s V_{OUT} 2 \sqrt{3}}$$

7. Select Compensator Components

Current Mode control method employed by the NCV8877 allows the use of a simple, Type II compensation to optimize the dynamic response according to system requirements.

8. Select MOSFET(s)

In order to ensure the gate drive voltage does not drop out the MOSFET(s) chosen must not violate the following inequality:

$$Q_{g(total)} \leq \frac{I_{drv}}{f_s}$$

Where: $Q_{g(total)}$: Total Gate Charge of MOSFET(s) [C]

I_{drv} : Drive voltage current [A]

f_s : Switching Frequency [Hz]

The maximum RMS Current can be calculated as follows:

$$I_{Q(max)} = I_{out} \frac{\sqrt{D}}{D'}$$

The maximum voltage across the MOSFET will be the maximum output voltage, which is the higher of the maximum input voltage and the regulated output voltage:

$$V_{Q(max)} = V_{OUT(max)}$$

9. Select Diode

The output diode rectifies the output current. The average current through diode will be equal to the output current:

$$I_{D(avg)} = I_{OUT(max)}$$

Additionally, the diode must block voltage equal to the higher of the output voltage and the maximum input voltage:

$$V_{D(max)} = V_{OUT(max)}$$

The maximum power dissipation in the diode can be calculated as follows:

$$P_D = V_{f(max)} I_{OUT(max)}$$

Where: P_d : Power dissipation in the diode [W]
 $V_{f(max)}$: Maximum forward voltage of the diode [V]

10. Design Notes

- VOUT serves a dual purpose (feedback and IC power). The VDRV circuit has a current pulse power draw resulting in current flow from the output sense location to the IC. Trace ESL will cause voltage ripple to develop at IC pin VOUT which could affect performance.
 - ◆ Use a 1 μ F IC VOUT pin decoupling capacitor close to IC in addition to the VDRV decoupling capacitor.
- Classic feedback loop measurements are not possible (VOUT pin serves a dual purpose as a feedback path and IC power). Feedback loop computer modeling recommended.
 - ◆ A step load test for stability verification is recommended.
- Compensation ground must be dedicated and connected directly to IC ground.
 - ◆ Do not use vias. Use a dedicated ground trace.
- ROSC programming resistor ground must be dedicated and connected directly to IC ground
 - ◆ Do not use vias. Use a dedicated ground trace.
- IC ground & current sense resistor ground sense point must be located on the same side of PCB.
 - ◆ Vias introduce sufficient ESR/ESL voltage drop which can degrade the accuracy of the current feedback signal amplitude (signal bounce) and should be avoided.
- Star ground should be located at IC ground pad.
 - ◆ This is the location for connecting the compensation and current sense grounds.
- The IC architecture has a leading edge ISNS blanking circuit. In some instances, current pulse leading edge current spike RC filter may be required.
 - ◆ If required, 330 pF + 250 Ω are a recommended evaluation starting point.
- $R_{DAMPING}$ (optional)
 - ◆ The IC-VOUT pin may be located a few cm from the output voltage sensing point. Parasitic inductance from the feedback trace (roughly 5 nH/cm) results in the requirement for a decoupling capacitor ($C_{decoupling} = 1 \mu$ F recommended) next to the IC-VOUT pin to support the VDRV charging pulses. The IC-VDRV energy is replenished from current pulses by an internal linear regulator whose charging frequency corresponds to that of the IC oscillator (phase lag may occur; some charging pulses may occasionally be skipped depending on the state of the VDRV voltage). The trace's parasitic inductance can introduce a low amplitude damped voltage oscillation between the IC-VOUT and the

output voltage sense location which may result in minor frequency jitter.

- ◆ If the measured frequency jitter is objectionable, it may be attenuated by placing a series damping resistor (R_{damp}) in the feedback path between the output voltage sense and IC-VOUT. The resulting filter introduced by R_{damp} introduces a high frequency pole in the feedback loop path. The RC filter 3 dB pole frequency must be chosen at a minimum of 1 decade above the design's feedback loop cross-over frequency (at minimum power supply input voltage where the worst case phase margin will occur) to avoid deteriorating the feedback loop cross-over frequency phase margin.
- ◆ The average operating current demand from the IC is dominated by the MOSFET gate drive power energy consumption ($I_{VDRV} = Q_g(tot)_{6V} \times f_{osc}$). The $I_{VDRV} \times R_{damp}$ voltage drop results in a corresponding increase in power supply regulation voltage. R_{damp} is typically 0.68 Ω , so the resulting increase in output voltage regulation will be minimal (10-30 mV may be typical).

11. Determine Feedback Loop Compensation Network

The purpose of a compensation network is to stabilize the dynamic response of the converter. By optimizing the compensation network, stable regulation response is achieved for input line and load transients.

Compensator design involves the placement of poles and zeros in the closed loop transfer function. Losses from the boost inductor, MOSFET, current sensing and boost diode losses also influence the gain and compensation expressions. The OTA has an ESD protection structure ($R_{ESD} \approx 502 \Omega$, data not provided in the datasheet) located on the die between the OTA output and the IC package compensation pin (VC). The information from the OTA PWM feedback control signal (V_{CTRL}) may differ from the IC-VC signal if R_2 is of similar order of magnitude as R_{ESD} . The compensation and gain expressions which follow take influence from the OTA output impedance elements into account.

Type-I compensation is not possible due to the presence of R_{ESD} . The Figure 17 compensation network corresponds to a Type-II network in series with R_{ESD} . The resulting control-output transfer function is an accurate mathematical model of the IC in a boost converter topology. The model does have limitations and a more accurate SPICE model should be considered for a more detailed analysis:

- The attenuating effect of large value ceramic capacitors in parallel with output electrolytic capacitor ESR is not considered in the equations.
- The efficiency term η should be a reasonable operating condition estimate.

NCV8877

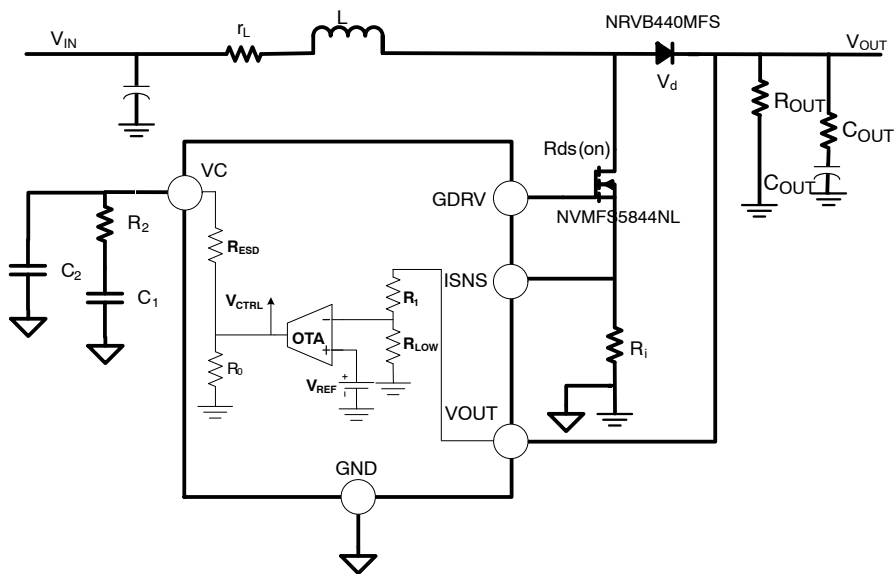

Figure 17. NCV8877 OTA and Compensation

A worksheet as well as a SPICE model which may be used for selecting compensation components R_2 , C_1 , C_2 is available at the ON Semiconductor web site (<http://onsemi.com/PowerSolutions/product.do?id=NCV8877>). The following equations may be used to analyze the Figure 10 boost converter. Required input design parameters for analysis are:

V_d = Boost diode V_f (V)
 V_{IN} = Boost supply input voltage (V)
 R_i = Current sense resistor (Ω)
 $R_{DS(on)}$ = MOSFET $R_{DS(on)}$ (Ω)
 C_{OUT} = Bulk output capacitor value (F)
 $R_{sw_eq} = R_{DS(on)} + R_i$, for the boost continuous conduction mode (CCM) expressions
 r_{CF} = Bulk output capacitor ESR (Ω)

R_{OUT} = Equivalent resistance of output load (Ω)
 P_{out} = Output Power (W)
 L = Boost inductor value (H)
 r_L = Boost inductor ESR (Ω)
 $T_s = 1/f_s$, where f_s = clock frequency (Hz)
 V_{OUT} = Device specific output voltage (e.g. 6.8 V for NCV887701) (V)
 V_{ref} = OTA internal voltage reference = 1.2 V
 R_0 = OTA output resistance = 3 M Ω
 S_a = IC slope compensation (e.g. 53 mV/ μ s for NCV887701)
 g_m = OTA transconductance = 1.2 mS
 D = Controller duty ratio
 $D' = 1 - D$

Necessary equations for describing the modulator gain ($V_{ctrl-to-V_{out}}$ gain) $H_{ctrl_output}(f)$ are described in Table 1.

Table 1. BOOST CCM TRANSFER FUNCTION EXPRESSIONS

Duty ratio (D)	$\frac{\left(2R_{OUT}V_dV_{IN} - \left[R_{sw_eq} + R_{OUT}\left(\frac{V_{IN}}{V_{OUT}} - 2\right)\right]V_{OUT}^2 - V_{OUT}\sqrt{R_{OUT}\left(\frac{R_{OUT}V_{IN}^2 + 2R_{sw_eq}V_{IN}V_{OUT} - 4V_dR_{sw_eq}V_{IN}}{-4R_{sw_eq}V_{OUT}^2 - 4r_LV_dV_{IN} - 4r_LV_{OUT}^2}\right) + R_{sw_eq}^2V_{OUT}^2}}{2R_{OUT}(V_{OUT}^2 + V_dV_{IN})}\right)}{2R_{OUT}(V_{OUT}^2 + V_dV_{IN})}$
V_{out}/V_{in} Power Supply DC Conversion Ratio (M)	$\frac{1}{1-D} \left[1 - \frac{(1-D)V_d}{V_{OUT}} \right] \left[1 + \frac{1}{(1-D)^2 \left(\frac{r_L + DR_{sw_eq}}{R_{OUT}} \right)} \right]$
Average Inductor Current (I_{lave})	$\frac{P_{OUT}}{V_{IN}\eta}$
Inductor On-slope (S_n)	$\frac{V_{IN} - I_{lave}(r_L + R_{sw_eq})}{L} R_i$
Compensation Ramp (m_c)	$1 + \frac{S_a}{S_n}$
C_{out} ESR Zero (ω_{z1})	$\frac{1}{r_{CF}C_{OUT}}$
Right-half-plane Zero (ω_{z2})	$\frac{(1-D)^2}{L} \left(R_{OUT} - \frac{r_{CF}R_{OUT}}{r_{CF} + R_{OUT}} \right) - \frac{r_L}{L}$
Low Frequency Modulator Pole (ω_{p1})	$\frac{\frac{2}{R_{OUT}} + \frac{T_s}{LM^3} m_c}{C_{OUT}}$
Sampling Double Pole (ω_n)	$\frac{\pi}{T_s}$
Sampling Quality Coefficient (Q_p)	$\frac{1}{\pi(m_c(1-D) - 0.5)}$
F_m	$\frac{1}{2M + \frac{R_{OUT}T_s}{LM^2} \left(\frac{1}{2} + \frac{S_a}{S_n} \right)}$
H_d	$\frac{\eta R_{OUT}}{R_i}$
Control-output Transfer Function ($H_{ctrl_output}(f)$)	$F_m H_d \frac{\left(1 + j\frac{2\pi f}{\omega_{z1}}\right)}{\left(1 + j\frac{2\pi f}{\omega_{p1}}\right)} \frac{\left(1 - j\frac{2\pi f}{\omega_{z2}}\right)}{\left(1 + j\frac{2\pi f}{\omega_n Q_p} + \left(j\frac{2\pi f}{\omega_n}\right)^2\right)}$

Once the desired cross-over frequency (f_c) gain adjustment and necessary phase boost are determined from the $H_{ctrl_output}(f)$ gain and phase plots, the Table 2 equations may be used. It should be noted that minor compensation component value adjustments may become necessary when $R_2 \leq \sim 10 \cdot R_{esd}$ as a result of approximations for determining components R_2 , C_1 , C_2 .

Table 2. OTA COMPENSATION TRANSFER FUNCTION AND COMPENSATION VALUES

Desired OTA Gain at Cross-over Frequency f_c (G)	$\frac{\text{desired } G_{fc_gain_db}}{10 \frac{20}{20}}$
Desired Phase Boost at Cross-over Frequency f_c (boost)	$\left(\theta_{\text{margin}} - \arg(H_{\text{ctrl_output}}(fc)) \frac{180^\circ}{\pi} - 90^\circ \right) \frac{\pi}{180^\circ}$
Select OTA Compensation Zero to Coincide with Modulator Pole at f_{p1} (f_z)	$\frac{\omega_{p1e}}{2\pi}$
Resulting OTA High Frequency Pole Placement (f_p)	$\frac{f_z f_c + f_c^2 \tan(\text{boost})}{f_c - f_z \tan(\text{boost})}$
Compensation Resistor (R_2)	$\frac{f_p G}{f_p - f_z} \frac{V_{\text{OUT}}}{1.2 g_m} \frac{\sqrt{1 + \left(\frac{f_c}{f_p}\right)^2}}{\sqrt{1 + \left(\frac{f_z}{f_p}\right)^2}}$
Compensation Capacitor (C_1)	$\frac{1}{2\pi f_z R_2}$
Compensation Capacitor (C_2)	$\frac{1}{2\pi f_p} \frac{1.2 g_m}{V_{\text{OUT}}}$
OTA DC Gain (G_{0_OTA})	$\frac{V_{\text{ref}}}{V_{\text{OUT}}} g_m R_0$
Low Frequency Zero (ω_{z1e})	$\frac{1}{2} \frac{(R_2 + R_{\text{esd}})}{R_2 R_{\text{esd}} C_2} \left[1 - \sqrt{1 - 4 \frac{R_2 R_{\text{esd}} C_2}{(R_2 + R_{\text{esd}})^2 C_1}} \right]$
High Frequency Zero (ω_{z2e})	$\frac{1}{2} \frac{(R_2 + R_{\text{esd}})}{R_2 R_{\text{esd}} C_2} \left[1 + \sqrt{1 - 4 \frac{R_2 R_{\text{esd}} C_2}{(R_2 + R_{\text{esd}})^2 C_1}} \right]$
Low Frequency Pole (ω_{p1e})	$\frac{1}{2} \frac{(R_0 + R_2 + R_{\text{esd}})}{R_2 (R_0 + R_{\text{esd}}) C_2} \left[1 - \sqrt{1 - 4 \frac{R_2 (R_0 + R_{\text{esd}}) C_2}{(R_0 + R_2 + R_{\text{esd}})^2 C_1}} \right]$
High Frequency Pole (ω_{p2e})	$\frac{1}{2} \frac{(R_0 + R_2 + R_{\text{esd}})}{R_2 (R_0 + R_{\text{esd}}) C_2} \left[1 + \sqrt{1 - 4 \frac{R_2 (R_0 + R_{\text{esd}}) C_2}{(R_0 + R_2 + R_{\text{esd}})^2 C_1}} \right]$
OTA Transfer Function ($G_{\text{OTA}}(f)$)	$-G_{0_OTA} \frac{1 + j \frac{2\pi f}{\omega_{z1e}}}{1 + j \frac{2\pi f}{\omega_{p1e}}} \frac{1 + j \frac{2\pi f}{\omega_{z2e}}}{1 + j \frac{2\pi f}{\omega_{p2e}}}$

The open-loop-response in closed-loop form to verify the gain/phase margins may be obtained from the following expressions.

$$T(f) = G_{\text{OTA}}(f) H_{\text{ctrl_output}}(f)$$

MECHANICAL CASE OUTLINE PACKAGE DIMENSIONS

ON Semiconductor®



SOIC-8 NB CASE 751-07 ISSUE AK

DATE 16 FEB 2011



SCALE 1:1

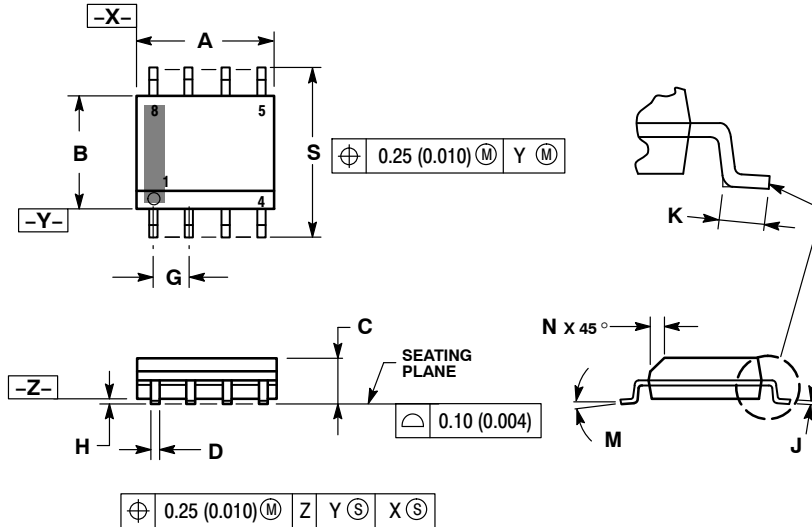

NOTES:

1. DIMENSIONING AND TOLERANCING PER ANSI Y14.5M, 1982.
2. CONTROLLING DIMENSION: MILLIMETER.
3. DIMENSION A AND B DO NOT INCLUDE MOLD PROTRUSION.
4. MAXIMUM MOLD PROTRUSION 0.15 (0.006) PER SIDE.
5. DIMENSION D DOES NOT INCLUDE DAMBAR PROTRUSION. ALLOWABLE DAMBAR PROTRUSION SHALL BE 0.127 (0.005) TOTAL IN EXCESS OF THE D DIMENSION AT MAXIMUM MATERIAL CONDITION.
6. 751-01 THRU 751-06 ARE OBSOLETE. NEW STANDARD IS 751-07.

DIM	MILLIMETERS		INCHES	
	MIN	MAX	MIN	MAX
A	4.80	5.00	0.189	0.197
B	3.80	4.00	0.150	0.157
C	1.35	1.75	0.053	0.069
D	0.33	0.51	0.013	0.020
G	1.27 BSC		0.050 BSC	
H	0.10	0.25	0.004	0.010
J	0.19	0.25	0.007	0.010
K	0.40	1.27	0.016	0.050
M	0°	8°	0°	8°
N	0.25	0.50	0.010	0.020
S	5.80	6.20	0.228	0.244

GENERIC MARKING DIAGRAM*

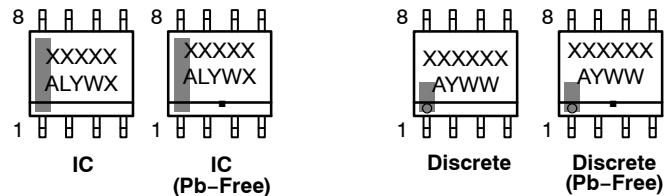
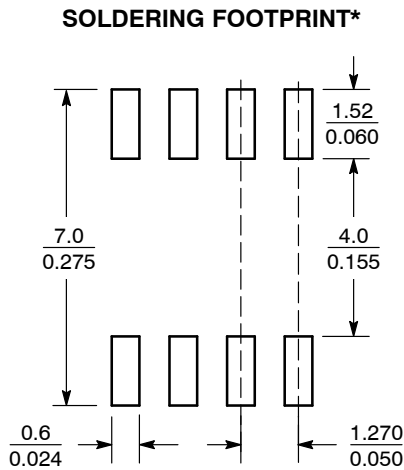

XXXXXX = Specific Device Code
 A = Assembly Location
 L = Wafer Lot
 Y = Year
 W = Work Week
 ■ = Pb-Free Package

XXXXXX = Specific Device Code
 A = Assembly Location
 Y = Year
 WW = Work Week
 ■ = Pb-Free Package

*This information is generic. Please refer to device data sheet for actual part marking. Pb-Free indicator, "G", may or not be present.

SCALE 6:1 (mm/inches)

*For additional information on our Pb-Free strategy and soldering details, please download the ON Semiconductor Soldering and Mounting Techniques Reference Manual, SOLDERRM/D.

STYLES ON PAGE 2

DOCUMENT NUMBER:	98ASB42564B	Electronic versions are uncontrolled except when accessed directly from the Document Repository. Printed versions are uncontrolled except when stamped "CONTROLLED COPY" in red.
STATUS:	ON SEMICONDUCTOR STANDARD	
NEW STANDARD:		
DESCRIPTION:	SOIC-8, NB	PAGE 1 OF 3

SOIC-8 NB
CASE 751-07
ISSUE AK

DATE 16 FEB 2011

- | | | | |
|---|--|--|--|
| <p>STYLE 1:
 PIN 1. EMITTER
 2. COLLECTOR
 3. COLLECTOR
 4. EMITTER
 5. EMITTER
 6. BASE
 7. BASE
 8. EMITTER</p> | <p>STYLE 2:
 PIN 1. COLLECTOR, DIE, #1
 2. COLLECTOR, #1
 3. COLLECTOR, #2
 4. COLLECTOR, #2
 5. BASE, #2
 6. EMITTER, #2
 7. BASE, #1
 8. EMITTER, #1</p> | <p>STYLE 3:
 PIN 1. DRAIN, DIE #1
 2. DRAIN, #1
 3. DRAIN, #2
 4. DRAIN, #2
 5. GATE, #2
 6. SOURCE, #2
 7. GATE, #1
 8. SOURCE, #1</p> | <p>STYLE 4:
 PIN 1. ANODE
 2. ANODE
 3. ANODE
 4. ANODE
 5. ANODE
 6. ANODE
 7. ANODE
 8. COMMON CATHODE</p> |
| <p>STYLE 5:
 PIN 1. DRAIN
 2. DRAIN
 3. DRAIN
 4. DRAIN
 5. GATE
 6. GATE
 7. SOURCE
 8. SOURCE</p> | <p>STYLE 6:
 PIN 1. SOURCE
 2. DRAIN
 3. DRAIN
 4. SOURCE
 5. SOURCE
 6. GATE
 7. GATE
 8. SOURCE</p> | <p>STYLE 7:
 PIN 1. INPUT
 2. EXTERNAL BYPASS
 3. THIRD STAGE SOURCE
 4. GROUND
 5. DRAIN
 6. GATE 3
 7. SECOND STAGE Vd
 8. FIRST STAGE Vd</p> | <p>STYLE 8:
 PIN 1. COLLECTOR, DIE #1
 2. BASE, #1
 3. BASE, #2
 4. COLLECTOR, #2
 5. COLLECTOR, #2
 6. EMITTER, #2
 7. EMITTER, #1
 8. COLLECTOR, #1</p> |
| <p>STYLE 9:
 PIN 1. EMITTER, COMMON
 2. COLLECTOR, DIE #1
 3. COLLECTOR, DIE #2
 4. EMITTER, COMMON
 5. EMITTER, COMMON
 6. BASE, DIE #2
 7. BASE, DIE #1
 8. EMITTER, COMMON</p> | <p>STYLE 10:
 PIN 1. GROUND
 2. BIAS 1
 3. OUTPUT
 4. GROUND
 5. GROUND
 6. BIAS 2
 7. INPUT
 8. GROUND</p> | <p>STYLE 11:
 PIN 1. SOURCE 1
 2. GATE 1
 3. SOURCE 2
 4. GATE 2
 5. DRAIN 2
 6. DRAIN 2
 7. DRAIN 1
 8. DRAIN 1</p> | <p>STYLE 12:
 PIN 1. SOURCE
 2. SOURCE
 3. SOURCE
 4. GATE
 5. DRAIN
 6. DRAIN
 7. DRAIN
 8. DRAIN</p> |
| <p>STYLE 13:
 PIN 1. N.C.
 2. SOURCE
 3. SOURCE
 4. GATE
 5. DRAIN
 6. DRAIN
 7. DRAIN
 8. DRAIN</p> | <p>STYLE 14:
 PIN 1. N-SOURCE
 2. N-GATE
 3. P-SOURCE
 4. P-GATE
 5. P-DRAIN
 6. P-DRAIN
 7. N-DRAIN
 8. N-DRAIN</p> | <p>STYLE 15:
 PIN 1. ANODE 1
 2. ANODE 1
 3. ANODE 1
 4. ANODE 1
 5. CATHODE, COMMON
 6. CATHODE, COMMON
 7. CATHODE, COMMON
 8. CATHODE, COMMON</p> | <p>STYLE 16:
 PIN 1. EMITTER, DIE #1
 2. BASE, DIE #1
 3. EMITTER, DIE #2
 4. BASE, DIE #2
 5. COLLECTOR, DIE #2
 6. COLLECTOR, DIE #2
 7. COLLECTOR, DIE #1
 8. COLLECTOR, DIE #1</p> |
| <p>STYLE 17:
 PIN 1. VCC
 2. V2OUT
 3. V1OUT
 4. TXE
 5. RXE
 6. VEE
 7. GND
 8. ACC</p> | <p>STYLE 18:
 PIN 1. ANODE
 2. ANODE
 3. SOURCE
 4. GATE
 5. DRAIN
 6. DRAIN
 7. CATHODE
 8. CATHODE</p> | <p>STYLE 19:
 PIN 1. SOURCE 1
 2. GATE 1
 3. SOURCE 2
 4. GATE 2
 5. DRAIN 2
 6. MIRROR 2
 7. DRAIN 1
 8. MIRROR 1</p> | <p>STYLE 20:
 PIN 1. SOURCE (N)
 2. GATE (N)
 3. SOURCE (P)
 4. GATE (P)
 5. DRAIN
 6. DRAIN
 7. DRAIN
 8. DRAIN</p> |
| <p>STYLE 21:
 PIN 1. CATHODE 1
 2. CATHODE 2
 3. CATHODE 3
 4. CATHODE 4
 5. CATHODE 5
 6. COMMON ANODE
 7. COMMON ANODE
 8. CATHODE 6</p> | <p>STYLE 22:
 PIN 1. I/O LINE 1
 2. COMMON CATHODE/VCC
 3. COMMON CATHODE/VCC
 4. I/O LINE 3
 5. COMMON ANODE/GND
 6. I/O LINE 4
 7. I/O LINE 5
 8. COMMON ANODE/GND</p> | <p>STYLE 23:
 PIN 1. LINE 1 IN
 2. COMMON ANODE/GND
 3. COMMON ANODE/GND
 4. LINE 2 IN
 5. LINE 2 OUT
 6. COMMON ANODE/GND
 7. COMMON ANODE/GND
 8. LINE 1 OUT</p> | <p>STYLE 24:
 PIN 1. BASE
 2. EMITTER
 3. COLLECTOR/ANODE
 4. COLLECTOR/ANODE
 5. CATHODE
 6. CATHODE
 7. COLLECTOR/ANODE
 8. COLLECTOR/ANODE</p> |
| <p>STYLE 25:
 PIN 1. VIN
 2. N/C
 3. REXT
 4. GND
 5. IOUT
 6. IOUT
 7. IOUT
 8. IOUT</p> | <p>STYLE 26:
 PIN 1. GND
 2. dv/dt
 3. ENABLE
 4. ILIMIT
 5. SOURCE
 6. SOURCE
 7. SOURCE
 8. VCC</p> | <p>STYLE 27:
 PIN 1. ILIMIT
 2. OVLO
 3. UVLO
 4. INPUT+
 5. SOURCE
 6. SOURCE
 7. SOURCE
 8. DRAIN</p> | <p>STYLE 28:
 PIN 1. SW_TO_GND
 2. DASIC_OFF
 3. DASIC_SW_DET
 4. GND
 5. V_MON
 6. VBULK
 7. VBULK
 8. VIN</p> |
| <p>STYLE 29:
 PIN 1. BASE, DIE #1
 2. EMITTER, #1
 3. BASE, #2
 4. EMITTER, #2
 5. COLLECTOR, #2
 6. COLLECTOR, #2
 7. COLLECTOR, #1
 8. COLLECTOR, #1</p> | <p>STYLE 30:
 PIN 1. DRAIN 1
 2. DRAIN 1
 3. GATE 2
 4. SOURCE 2
 5. SOURCE 1/DRAIN 2
 6. SOURCE 1/DRAIN 2
 7. SOURCE 1/DRAIN 2
 8. GATE 1</p> | | |

DOCUMENT NUMBER:	98ASB42564B	Electronic versions are uncontrolled except when accessed directly from the Document Repository. Printed versions are uncontrolled except when stamped "CONTROLLED COPY" in red.
STATUS:	ON SEMICONDUCTOR STANDARD	
NEW STANDARD:		
DESCRIPTION:	SOIC-8, NB	PAGE 2 OF 3

ON Semiconductor and  are trademarks of Semiconductor Components Industries, LLC dba ON Semiconductor or its subsidiaries in the United States and/or other countries. ON Semiconductor owns the rights to a number of patents, trademarks, copyrights, trade secrets, and other intellectual property. A listing of ON Semiconductor's product/patent coverage may be accessed at www.onsemi.com/site/pdf/Patent-Marking.pdf. ON Semiconductor reserves the right to make changes without further notice to any products herein. ON Semiconductor makes no warranty, representation or guarantee regarding the suitability of its products for any particular purpose, nor does ON Semiconductor assume any liability arising out of the application or use of any product or circuit, and specifically disclaims any and all liability, including without limitation special, consequential or incidental damages. Buyer is responsible for its products and applications using ON Semiconductor products, including compliance with all laws, regulations and safety requirements or standards, regardless of any support or applications information provided by ON Semiconductor. "Typical" parameters which may be provided in ON Semiconductor data sheets and/or specifications can and do vary in different applications and actual performance may vary over time. All operating parameters, including "Typicals" must be validated for each customer application by customer's technical experts. ON Semiconductor does not convey any license under its patent rights nor the rights of others. ON Semiconductor products are not designed, intended, or authorized for use as a critical component in life support systems or any FDA Class 3 medical devices or medical devices with a same or similar classification in a foreign jurisdiction or any devices intended for implantation in the human body. Should Buyer purchase or use ON Semiconductor products for any such unintended or unauthorized application, Buyer shall indemnify and hold ON Semiconductor and its officers, employees, subsidiaries, affiliates, and distributors harmless against all claims, costs, damages, and expenses, and reasonable attorney fees arising out of, directly or indirectly, any claim of personal injury or death associated with such unintended or unauthorized use, even if such claim alleges that ON Semiconductor was negligent regarding the design or manufacture of the part. ON Semiconductor is an Equal Opportunity/Affirmative Action Employer. This literature is subject to all applicable copyright laws and is not for resale in any manner.

PUBLICATION ORDERING INFORMATION

LITERATURE FULFILLMENT:

Literature Distribution Center for ON Semiconductor
19521 E. 32nd Pkwy, Aurora, Colorado 80011 USA
Phone: 303-675-2175 or 800-344-3860 Toll Free USA/Canada
Fax: 303-675-2176 or 800-344-3867 Toll Free USA/Canada
Email: orderlit@onsemi.com

N. American Technical Support: 800-282-9855 Toll Free
USA/Canada
Europe, Middle East and Africa Technical Support:
Phone: 421 33 790 2910

ON Semiconductor Website: www.onsemi.com

Order Literature: <http://www.onsemi.com/orderlit>

For additional information, please contact your local
Sales Representative