

NSPM3031

3.3V Bidirectional ESD and Surge Protection Device

The NSPM3031 is designed to protect voltage sensitive components from ESD. Excellent clamping capability, low leakage, high peak pulse current handling capability and fast response time provide best in class protection on designs that are exposed to ESD. Because of its small size, it is suited for use in cellular phones, tablets, MP3 players, digital cameras and many other portable applications where board space comes at a premium.

Features

- Low Clamping Voltage
- Low Leakage
- Small Body Outline: 1.0 mm x 0.6 mm
- Protection for the following IEC Standards:
 - IEC61000–4–2 Level 4: ± 30 kV Contact Discharge
 - IEC61000–4–5 (Lightning) 45 A (8/20 μ s)
- These Devices are Pb–Free, Halogen Free/BFR Free and are RoHS Compliant

Typical Applications

- Battery Line Protection
- Audio Line Protection
- GPIO

MAXIMUM RATINGS

Rating	Symbol	Value	Unit
IEC 61000–4–2 (ESD) Contact Air		± 30 ± 30	kV
Operating Junction and Storage Temperature Range	T_J, T_{stg}	–65 to +150	°C
Maximum Peak Pulse Current	I_{PP}	45	A

Stresses exceeding those listed in the Maximum Ratings table may damage the device. If any of these limits are exceeded, device functionality should not be assumed, damage may occur and reliability may be affected.



ON Semiconductor®

www.onsemi.com



X2DFN2
CASE 714AB

MARKING DIAGRAM

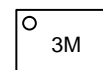

3 = Specific Device Code
M = Date Code

ORDERING INFORMATION

Device	Package	Shipping†
NSPM3031MXT5G	X2DFN2 (Pb–Free)	8000 / Tape & Reel

†For information on tape and reel specifications, including part orientation and tape sizes, please refer to our Tape and Reel Packaging Specifications Brochure, BRD8011/D.

ELECTRICAL CHARACTERISTICS

(T_A = 25°C unless otherwise noted)

Symbol	Parameter
I _{PP}	Maximum Reverse Peak Pulse Current
V _C	Clamping Voltage @ I _{PP}
V _{RWM}	Working Peak Reverse Voltage
I _R	Maximum Reverse Leakage Current @ V _{RWM}
V _{BR}	Breakdown Voltage @ I _T
I _T	Test Current

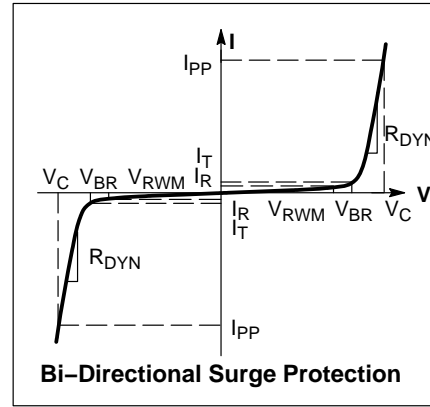

*See Application Note AND8308/D for detailed explanations of datasheet parameters.

ELECTRICAL CHARACTERISTICS (T_A = 25°C unless otherwise specified)

Parameter	Symbol	Conditions	Min	Typ	Max	Unit
Reverse Working Voltage	V _{RWM}	I/O Pin to GND			3.3	V
Breakdown Voltage	V _{BR}	I _T = 1 mA, I/O Pin to GND	4.0	4.6	5.5	V
Reverse Leakage Current	I _R	V _{RWM} = 3.3 V, I/O Pin to GND			0.1	μA
Clamping Voltage	V _C	IEC61000-4-2, ±8 kV Contact	See Figures 1 & 2			V
Clamping Voltage TLP (Note 1)	V _C	I _{PP} = 8 A, IEC61000-4-2 Level 2 Equivalent (±4 kV Contact, ± 8 kV Air)		5.0		V
		I _{PP} = 16 A, IEC61000-4-2 Level 4 Equivalent (±8 kV Contact, ± 15 kV Air)		5.3		
Reverse Peak Pulse Current	I _{PP}	IEC61000-4-5 (8 x 20 μs) per Figure 14	45			A
Clamping Voltage 8x20 μs Waveform per Figure 14 (Note 2)	V _C	I _{PP} = 1 A		4.5	5.5	V
		I _{PP} = 40 A		6.5	7.1	
		I _{PP} = 45 A		7.0	7.6	
Dynamic Resistance	R _{DYN}	100 ns TLP Pulse		0.037		Ω
Junction Capacitance	C _J	V _R = 0 V, f = 1 MHz		87	200	pF

Product parametric performance is indicated in the Electrical Characteristics for the listed test conditions, unless otherwise noted. Product performance may not be indicated by the Electrical Characteristics if operated under different conditions.

- ANSI/ESD STM5.5.1 Electrostatic Discharge Sensitivity Testing using Transmission Line Pulse (TLP) Model.
TLP conditions: Z₀ = 50 Ω, t_p = 100 ns, t_r = 0.1 ns, averaging window: t₁ = 70 ns to t₂ = 90 ns.
- Non-repetitive current pulse at T_A = 25°C, per IEC61000-4-5 waveform.

TYPICAL CHARACTERISTICS

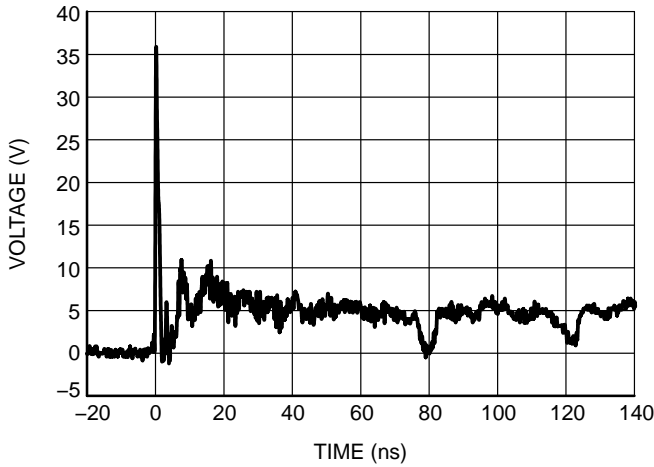

Figure 1. ESD Clamping Voltage
Positive 8 kV Contact per IEC61000-4-2

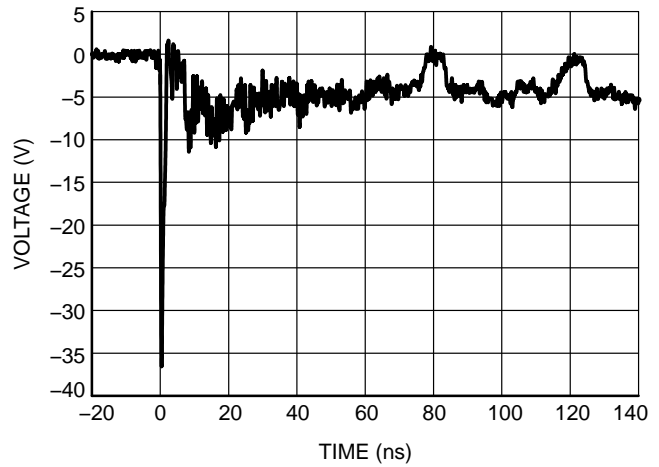

Figure 2. ESD Clamping Voltage
Negative 8 kV Contact per IEC61000-4-2

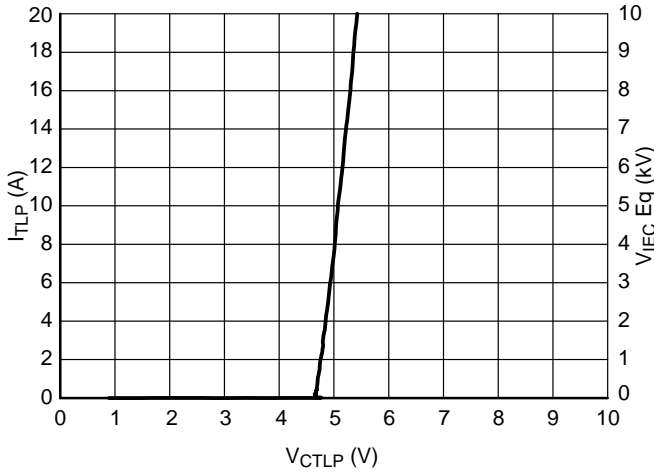

Figure 3. Positive TLP I-V Curve

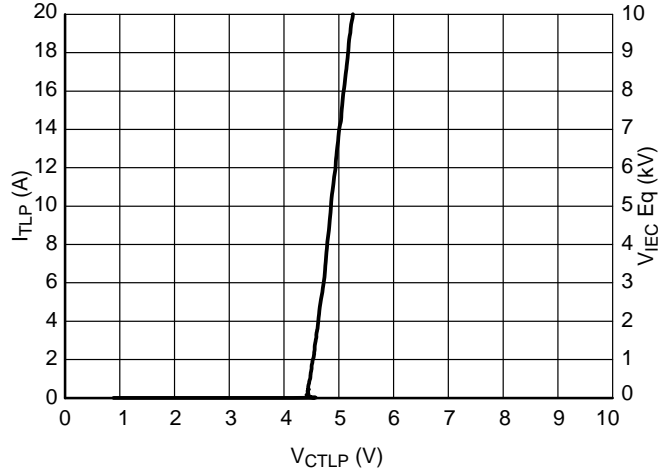

Figure 4. Negative TLP I-V Curve

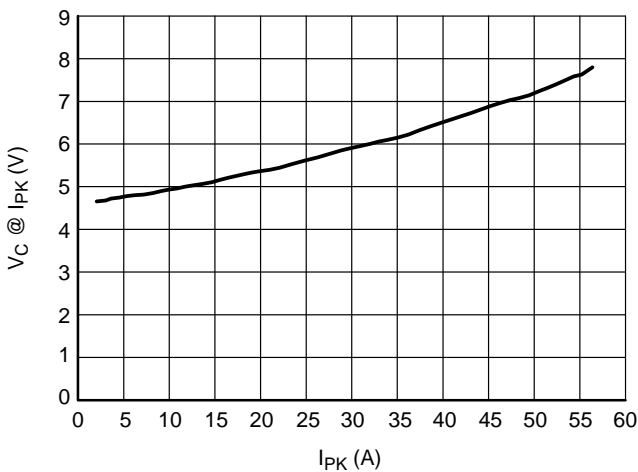

Figure 5. Positive Clamping Voltage vs. Peak
Pulse Current ($t_p = 8/20 \mu s$)

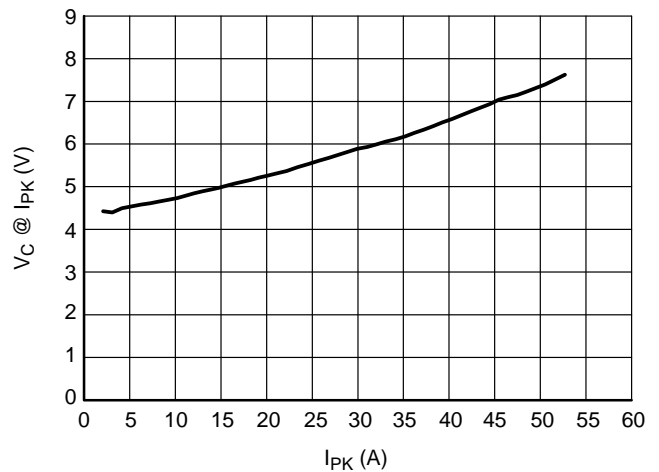

Figure 6. Negative Clamping Voltage vs. Peak
Pulse Current ($t_p = 8/20 \mu s$)

NSPM3031

TYPICAL CHARACTERISTICS

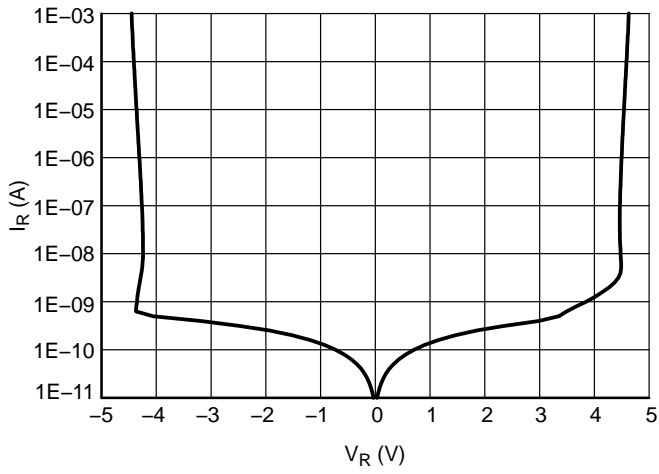

Figure 7. Breakdown Voltage

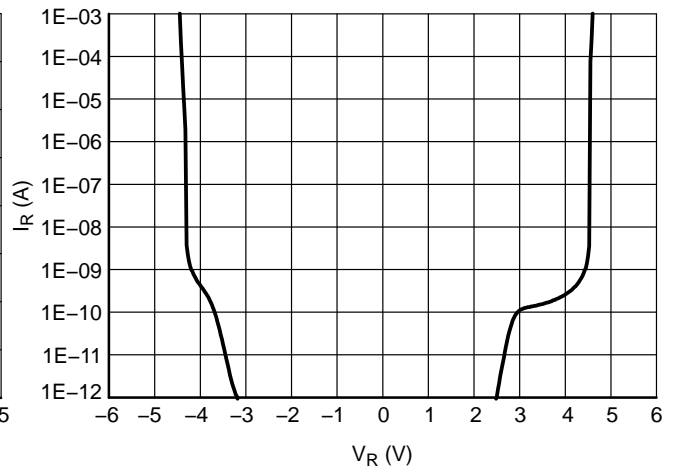

Figure 8. Reverse Leakage Current

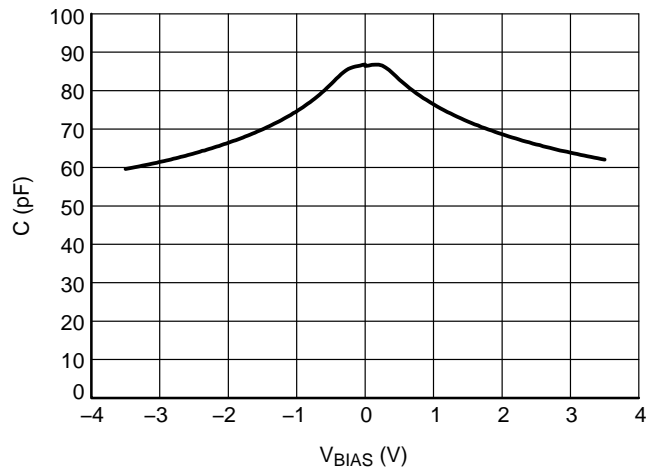

Figure 9. Line Capacitance, $f = 1$ MHz

Transmission Line Pulse (TLP) Measurement

Transmission Line Pulse (TLP) provides current versus voltage (I–V) curves in which each data point is obtained from a 100 ns long rectangular pulse from a charged transmission line. A simplified schematic of a typical TLP system is shown in Figure 10. TLP I–V curves of ESD protection devices accurately demonstrate the product’s ESD capability because the 10s of amps current levels and under 100 ns time scale match those of an ESD event. This is illustrated in Figure 11 where an 8 kV IEC 61000–4–2 current waveform is compared with TLP current pulses at 8 A and 16 A. A TLP I–V curve shows the voltage at which the device turns on as well as how well the device clamps voltage over a range of current levels. For more information on TLP measurements and how to interpret them please refer to AND9007/D.

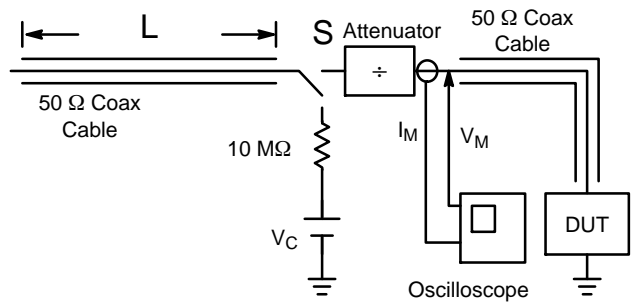

Figure 10. Simplified Schematic of a Typical TLP System

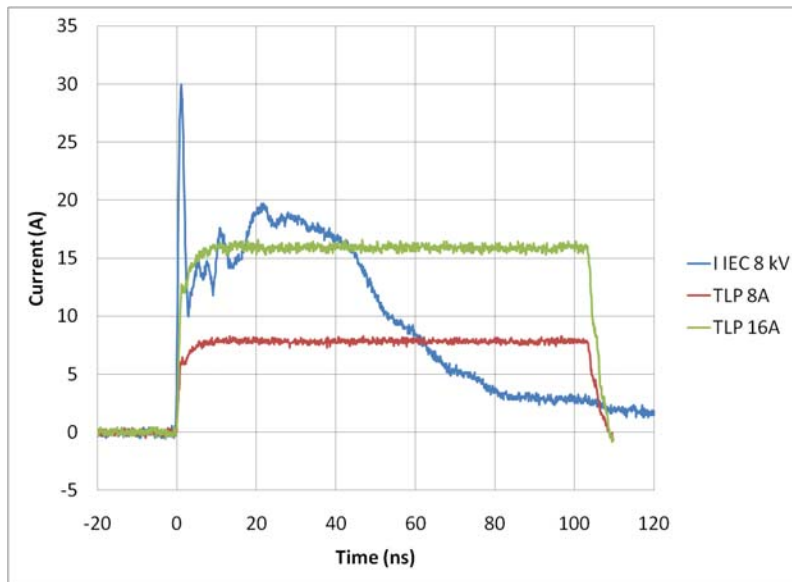

Figure 11. Comparison Between 8 kV IEC 61000–4–2 and 8 A and 16 A TLP Waveforms

IEC 61000-4-2 Spec.

Level	Test Voltage (kV)	First Peak Current (A)	Current at 30 ns (A)	Current at 60 ns (A)
1	2	7.5	4	2
2	4	15	8	4
3	6	22.5	12	6
4	8	30	16	8

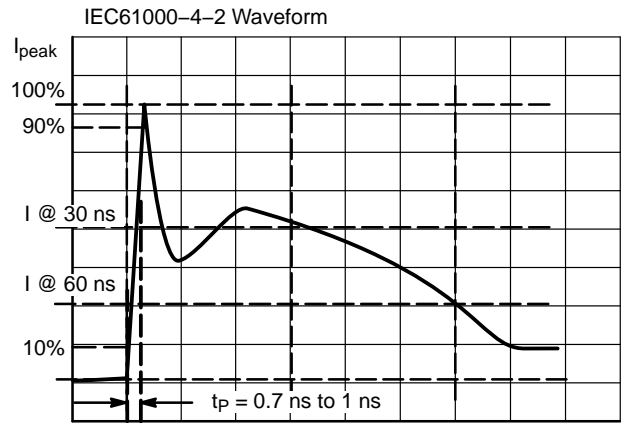

Figure 12. IEC61000-4-2 Spec

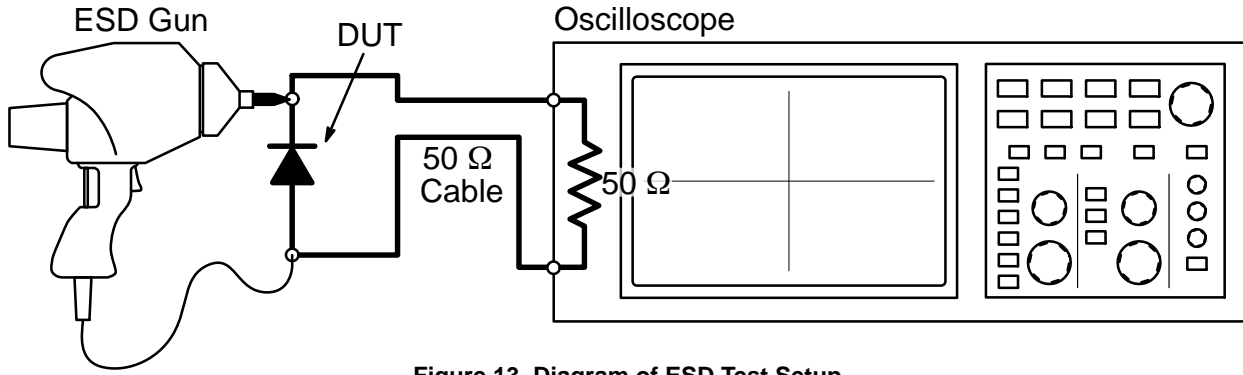

Figure 13. Diagram of ESD Test Setup

ESD Voltage Clamping

For sensitive circuit elements it is important to limit the voltage that an IC will be exposed to during an ESD event to as low a voltage as possible. The ESD clamping voltage is the voltage drop across the ESD protection diode during an ESD event per the IEC61000-4-2 waveform. Since the IEC61000-4-2 was written as a pass/fail spec for larger systems such as cell phones or laptop computers it is not clearly defined in the spec how to specify a clamping voltage

at the device level. ON Semiconductor has developed a way to examine the entire voltage waveform across the ESD protection diode over the time domain of an ESD pulse in the form of an oscilloscope screenshot, which can be found on the datasheets for all ESD protection diodes. For more information on how ON Semiconductor creates these screenshots and how to interpret them please refer to AND8307/D.

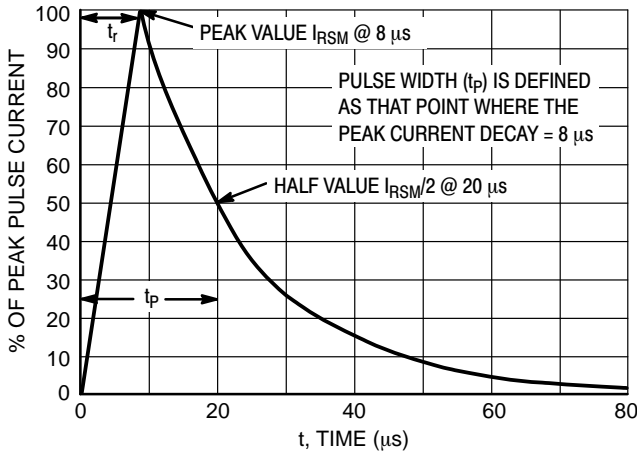
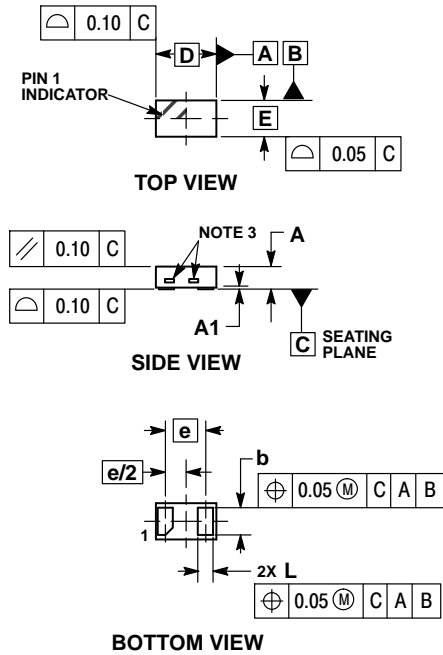

Figure 14. 8 X 20 μs Pulse Waveform

NSPM3031

PACKAGE DIMENSIONS

X2DFN2 1.0x0.6, 0.65P
CASE 714AB
ISSUE B



NOTES:

1. DIMENSIONING AND TOLERANCING PER ASME Y14.5M, 1994.
2. CONTROLLING DIMENSION: MILLIMETERS.
3. EXPOSED COPPER ALLOWED AS SHOWN.

DIM	MILLIMETERS		
	MIN	NOM	MAX
A	0.34	0.37	0.40
A1	—	0.03	0.05
b	0.45	0.50	0.55
D	0.95	1.00	1.05
E	0.55	0.60	0.65
e	0.65 BSC		
L	0.20	0.25	0.30

**RECOMMENDED
SOLDER FOOTPRINT***

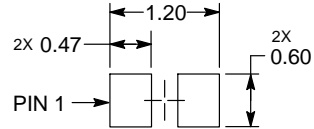

DIMENSIONS: MILLIMETERS

*This information is generic. Please refer to device data sheet for actual part marking. Pb-Free indicator, "G" or microdot "▪", may or may not be present. Some products may not follow the Generic Marking.

ON Semiconductor and are trademarks of Semiconductor Components Industries, LLC dba ON Semiconductor or its subsidiaries in the United States and/or other countries. ON Semiconductor owns the rights to a number of patents, trademarks, copyrights, trade secrets, and other intellectual property. A listing of ON Semiconductor's product/patent coverage may be accessed at www.onsemi.com/site/pdf/Patent-Marking.pdf. ON Semiconductor reserves the right to make changes without further notice to any products herein. ON Semiconductor makes no warranty, representation or guarantee regarding the suitability of its products for any particular purpose, nor does ON Semiconductor assume any liability arising out of the application or use of any product or circuit, and specifically disclaims any and all liability, including without limitation special, consequential or incidental damages. Buyer is responsible for its products and applications using ON Semiconductor products, including compliance with all laws, regulations and safety requirements or standards, regardless of any support or applications information provided by ON Semiconductor. "Typical" parameters which may be provided in ON Semiconductor data sheets and/or specifications can and do vary in different applications and actual performance may vary over time. All operating parameters, including "Typicals" must be validated for each customer application by customer's technical experts. ON Semiconductor does not convey any license under its patent rights nor the rights of others. ON Semiconductor products are not designed, intended, or authorized for use as a critical component in life support systems or any FDA Class 3 medical devices or medical devices with a same or similar classification in a foreign jurisdiction or any devices intended for implantation in the human body. Should Buyer purchase or use ON Semiconductor products for any such unintended or unauthorized application, Buyer shall indemnify and hold ON Semiconductor and its officers, employees, subsidiaries, affiliates, and distributors harmless against all claims, costs, damages, and expenses, and reasonable attorney fees arising out of, directly or indirectly, any claim of personal injury or death associated with such unintended or unauthorized use, even if such claim alleges that ON Semiconductor was negligent regarding the design or manufacture of the part. ON Semiconductor is an Equal Opportunity/Affirmative Action Employer. This literature is subject to all applicable copyright laws and is not for resale in any manner.

PUBLICATION ORDERING INFORMATION

LITERATURE FULFILLMENT:
Literature Distribution Center for ON Semiconductor
19521 E. 32nd Pkwy, Aurora, Colorado 80011 USA
Phone: 303-675-2175 or 800-344-3860 Toll Free USA/Canada
Fax: 303-675-2176 or 800-344-3867 Toll Free USA/Canada
Email: orderlit@onsemi.com

N. American Technical Support: 800-282-9855 Toll Free
USA/Canada
Europe, Middle East and Africa Technical Support:
Phone: 421 33 790 2910

ON Semiconductor Website: www.onsemi.com
Order Literature: <http://www.onsemi.com/orderlit>

For additional information, please contact your local Sales Representative