

# NTGS3433T1

## MOSFET – P-Channel, TSOP-6

**-3.3 A, -12 V**

### Features

- Ultra Low  $R_{DS(on)}$
- Higher Efficiency Extending Battery Life
- Miniature TSOP-6 Surface Mount Package
- Pb-Free Package is Available

### Applications

- Power Management in Portable and Battery-Powered Products, i.e.: Cellular and Cordless Telephones, and PCMCIA Cards

### MAXIMUM RATINGS ( $T_J = 25^\circ\text{C}$ unless otherwise noted.)

Rating	Symbol	Value	Unit
Drain-to-Source Voltage	$V_{DSS}$	-12	Volts
Gate-to-Source Voltage – Continuous	$V_{GS}$	$\pm 8.0$	Volts
Thermal Resistance Junction-to-Ambient (Note 1)	$R_{\theta JA}$	62.5	$^\circ\text{C/W}$
Total Power Dissipation @ $T_A = 25^\circ\text{C}$	$P_d$	2.0	Watts
Drain Current	$I_D$	-3.3	Amps
– Continuous @ $T_A = 25^\circ\text{C}$	$I_{DM}$	-20	Amps
– Pulsed Drain Current ( $T_p < 10 \mu\text{s}$ )	$P_d$	1.0	Watts
Maximum Operating Power Dissipation	$I_D$	-2.35	Amps
Maximum Operating Drain Current			
Thermal Resistance Junction-to-Ambient (Note 2)	$R_{\theta JA}$	128	$^\circ\text{C/W}$
Total Power Dissipation @ $T_A = 25^\circ\text{C}$	$P_d$	1.0	Watts
Drain Current	$I_D$	-2.35	Amps
– Continuous @ $T_A = 25^\circ\text{C}$	$I_{DM}$	-14	Amps
– Pulsed Drain Current ( $T_p < 10 \mu\text{s}$ )	$P_d$	0.5	Watts
Maximum Operating Power Dissipation	$I_D$	-1.65	Amps
Maximum Operating Drain Current			
Operating and Storage Temperature Range	$T_J, T_{stg}$	-55 to 150	$^\circ\text{C}$
Maximum Lead Temperature for Soldering Purposes for 10 Seconds	$T_L$	260	$^\circ\text{C}$

Maximum ratings are those values beyond which device damage can occur. Maximum ratings applied to the device are individual stress limit values (not normal operating conditions) and are not valid simultaneously. If these limits are exceeded, device functional operation is not implied, damage may occur and reliability may be affected.

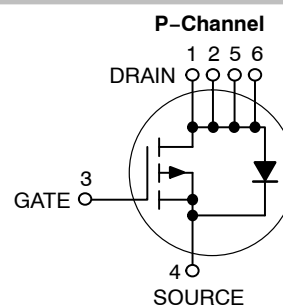
1. Mounted onto a 2" square FR-4 board (1 in sq, 2 oz. Cu 0.06" thick single sided),  $t < 5.0$  seconds.
2. Mounted onto a 2" square FR-4 board (1 in sq, 2 oz. Cu 0.06" thick single sided), operating to steady state.



**ON Semiconductor®**

<http://onsemi.com>

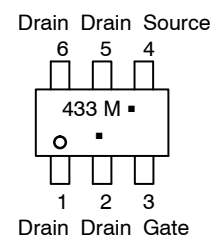
$V_{(BR)DSS}$	$R_{DS(on)}$ TYP	$I_D$ Max
-12 V	75 m $\Omega$ @ -4.5 V	-3.3 A



### MARKING DIAGRAM & PIN ASSIGNMENT



**TSOP-6  
CASE 318G  
STYLE 1**



433 = Specific Device Code  
M = Date Code\*  
▪ = Pb-Free Package

(Note: Microdot may be in either location)

\*Date Code orientation may vary depending upon manufacturing location.

### ORDERING INFORMATION

Device	Package	Shipping†
NTGS3433T1	TSOP-6	3000 Tape & Reel
NTGS3433T1G	TSOP-6 (Pb-Free)	3000 Tape & Reel

†For information on tape and reel specifications, including part orientation and tape sizes, please refer to our Tape and Reel Packaging Specification Brochure, BRD8011/D.

# NTGS3433T1

## ELECTRICAL CHARACTERISTICS ( $T_A = 25^\circ\text{C}$ unless otherwise noted) (Notes 3 & 4)

Characteristic	Symbol	Min	Typ	Max	Unit
----------------	--------	-----	-----	-----	------

### OFF CHARACTERISTICS

Drain-Source Breakdown Voltage ( $V_{GS} = 0\text{ Vdc}$ , $I_D = -10\ \mu\text{A}$ )	$V_{(BR)DSS}$	-12	-	-	Vdc
Zero Gate Voltage Drain Current ( $V_{GS} = 0\text{ Vdc}$ , $V_{DS} = -8\text{ Vdc}$ , $T_J = 25^\circ\text{C}$ ) ( $V_{GS} = 0\text{ Vdc}$ , $V_{DS} = -8\text{ Vdc}$ , $T_J = 70^\circ\text{C}$ )	$I_{DSS}$	-	-	-1.0 -5.0	$\mu\text{Adc}$
Gate-Body Leakage Current ( $V_{GS} = -8.0\text{ Vdc}$ , $V_{DS} = 0\text{ Vdc}$ )	$I_{GSS}$	-	-	-100	nAdc
Gate-Body Leakage Current ( $V_{GS} = +8.0\text{ Vdc}$ , $V_{DS} = 0\text{ Vdc}$ )	$I_{GSS}$	-	-	100	nAdc

### ON CHARACTERISTICS

Gate Threshold Voltage ( $V_{DS} = V_{GS}$ , $I_D = -250\ \mu\text{Adc}$ )	$V_{GS(th)}$	-0.50	-0.70	-1.50	Vdc
Static Drain-Source On-State Resistance ( $V_{GS} = -4.5\text{ Vdc}$ , $I_D = -3.3\text{ Adc}$ ) ( $V_{GS} = -2.5\text{ Vdc}$ , $I_D = -2.9\text{ Adc}$ )	$R_{DS(on)}$	-	0.055 0.075	0.075 0.095	$\Omega$
Forward Transconductance ( $V_{DS} = -10\text{ Vdc}$ , $I_D = -3.3\text{ Adc}$ )	$g_{FS}$	-	7.0	-	mhos

### DYNAMIC CHARACTERISTICS

Total Gate Charge	( $V_{DS} = -10\text{ Vdc}$ , $V_{GS} = -4.5\text{ Vdc}$ , $I_D = -3.3\text{ Adc}$ )	$Q_{tot}$	-	7.0	15	nC
Gate-Source Charge		$Q_{gs}$	-	2.0	-	
Gate-Drain Charge		$Q_{gd}$	-	3.5	-	
Input Capacitance	( $V_{DS} = -5.0\text{ Vdc}$ , $V_{GS} = 0\text{ Vdc}$ , $f = 1.0\text{ MHz}$ )	$C_{iss}$	-	550	-	pF
Output Capacitance		$C_{oss}$	-	450	-	
Reverse Transfer Capacitance		$C_{rss}$	-	200	-	

### SWITCHING CHARACTERISTICS

Turn-On Delay Time	( $V_{DD} = -10\text{ Vdc}$ , $I_D = -1.0\text{ Adc}$ , $V_{GS} = -4.5\text{ Vdc}$ , $R_g = 6.0\ \Omega$ )	$t_{d(on)}$	-	20	30	ns
Rise Time		$t_r$	-	20	30	
Turn-Off Delay Time		$t_{d(off)}$	-	110	120	
Fall Time		$t_f$	-	100	115	
Reverse Recovery Time	( $I_S = -1.7\text{ Adc}$ , $di_S/dt = 100\text{ A}/\mu\text{s}$ )	$t_{rr}$	-	30	-	ns

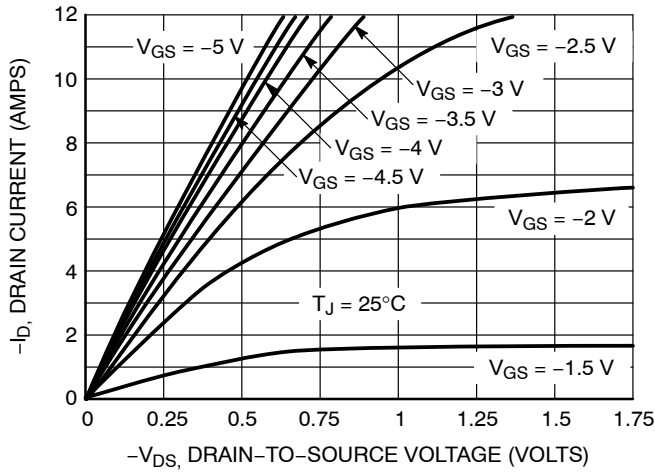
### BODY-DRAIN DIODE RATINGS

Diode Forward On-Voltage	( $I_S = -1.7\text{ Adc}$ , $V_{GS} = 0\text{ Vdc}$ )	$V_{SD}$	-	-0.80	-1.5	Vdc
Diode Forward On-Voltage	( $I_S = -3.3\text{ Adc}$ , $V_{GS} = 0\text{ Vdc}$ )	$V_{SD}$	-	-0.90	-	Vdc

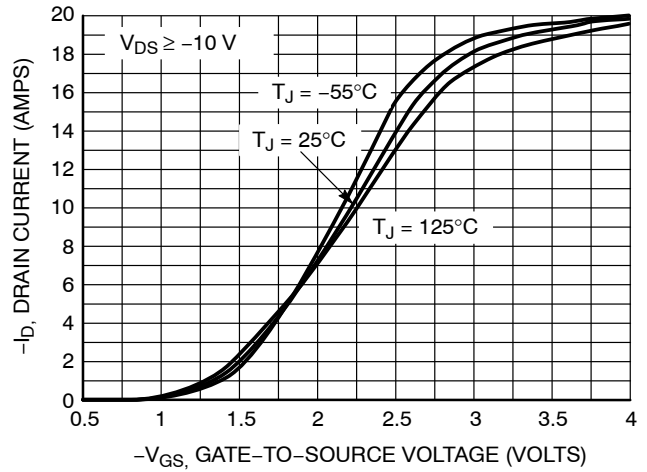
3. Indicates Pulse Test: P.W. = 300  $\mu\text{sec}$  max, Duty Cycle = 2%.

4. Class 1 ESD rated - Handling precautions to protect against electrostatic discharge are mandatory.

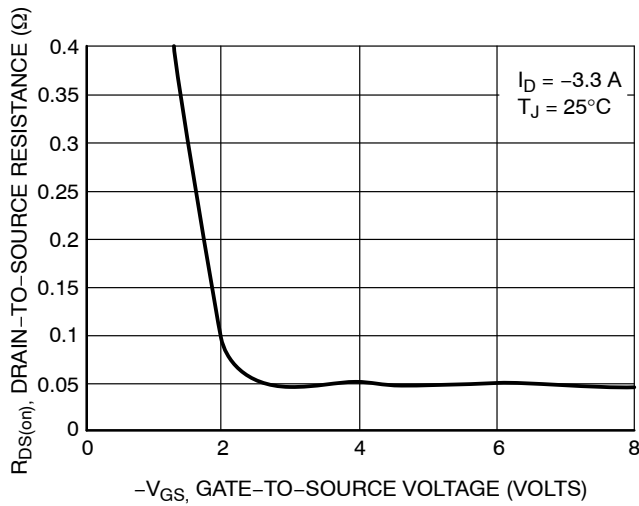
# NTGS3433T1



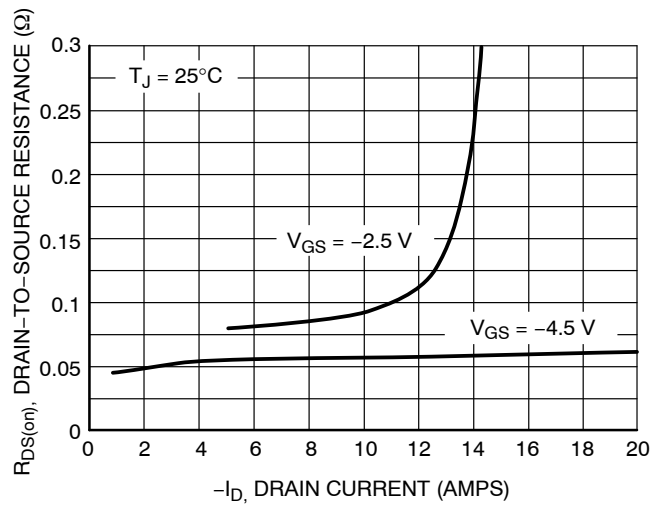
**Figure 1. On-Region Characteristics**



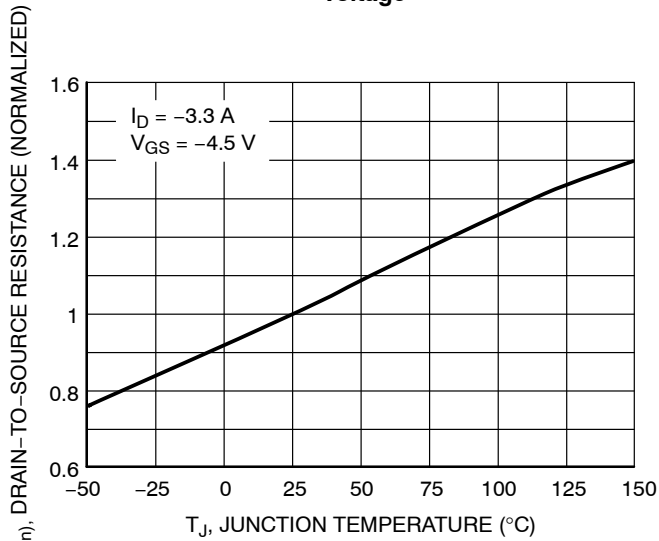
**Figure 2. Transfer Characteristics**



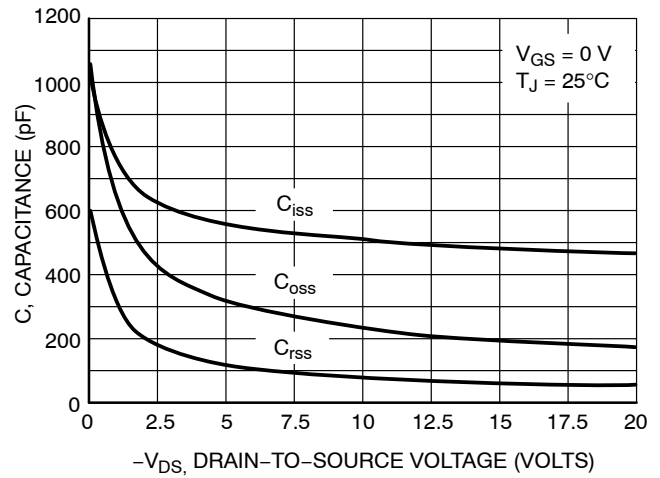
**Figure 3. On-Resistance vs. Gate-to-Source Voltage**



**Figure 4. On-Resistance vs. Drain Current and Gate Voltage**

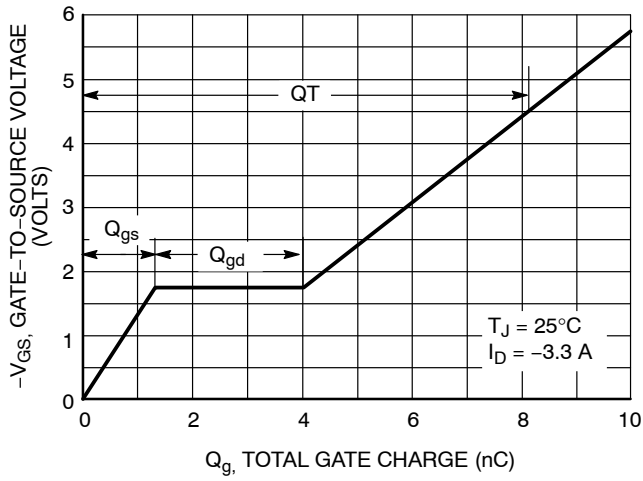


**Figure 5. On-Resistance Variation with Temperature**

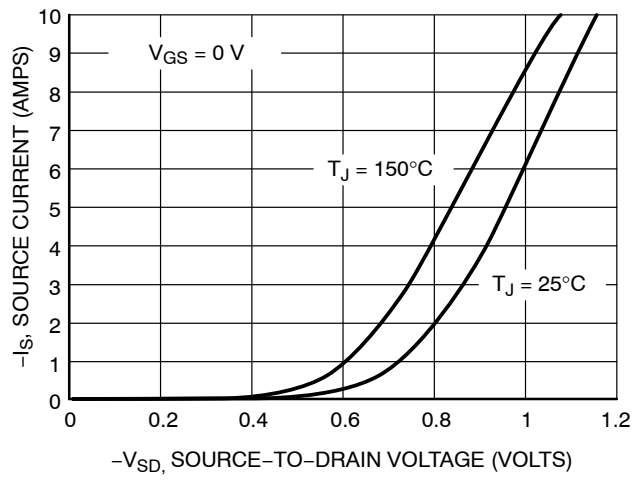


**Figure 6. Capacitance Variation**

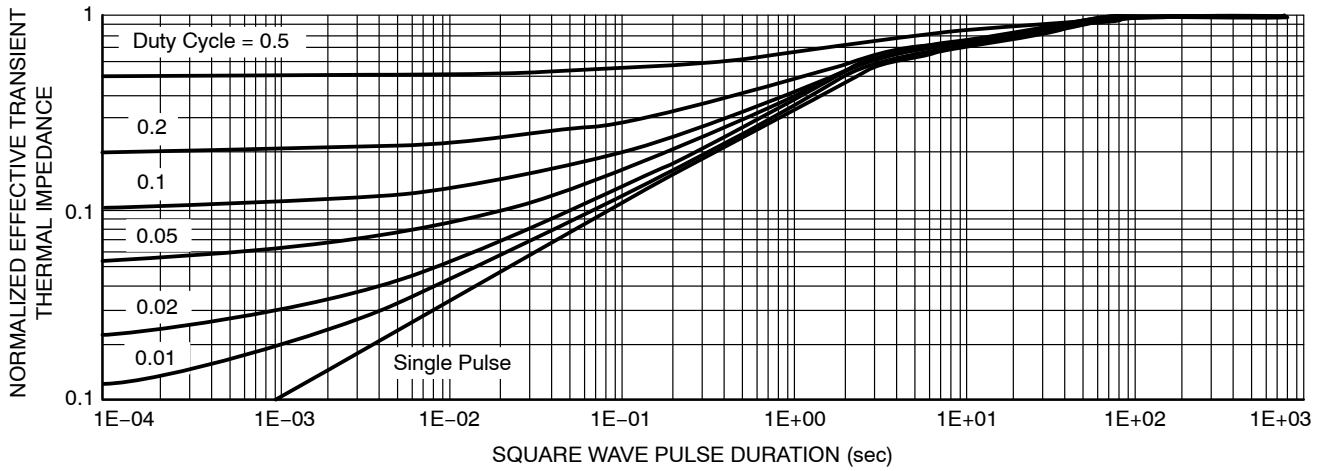
# NTGS3433T1



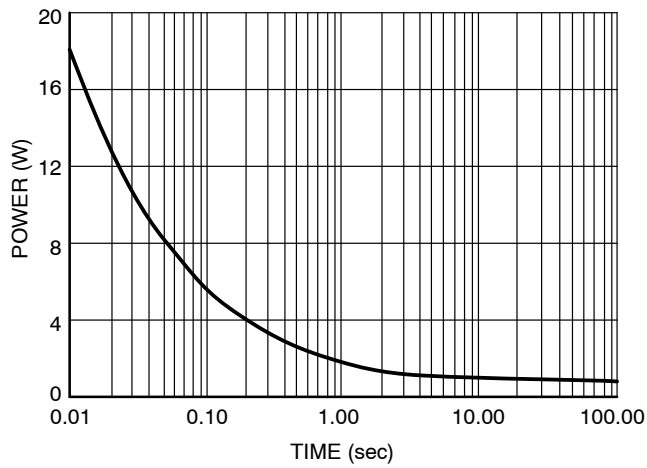
**Figure 7. Gate-to-Source and Drain-to-Source Voltage vs. Total Charge**



**Figure 8. Diode Forward Voltage vs. Current**



**Figure 9. Normalized Thermal Transient Impedance, Junction-to-Ambient**

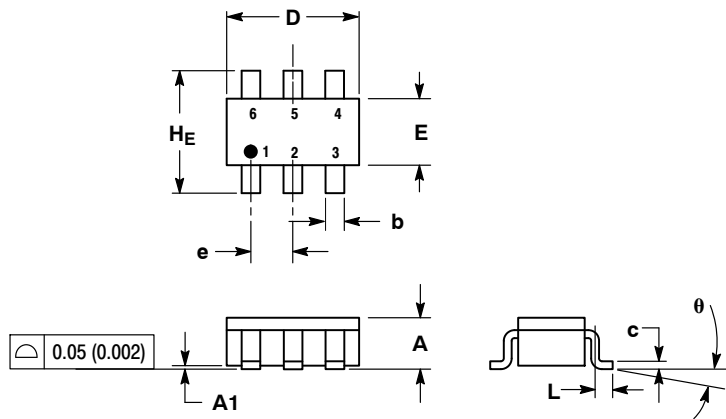


**Figure 10. Single Pulse Power**

# NTGS3433T1

## PACKAGE DIMENSIONS

TSOP-6  
CASE 318G-02  
ISSUE P



### NOTES:

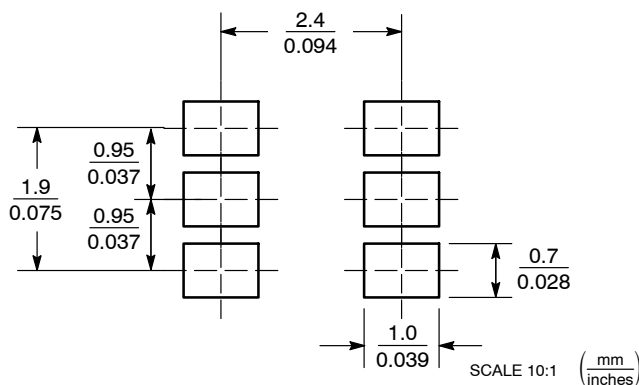
1. DIMENSIONING AND TOLERANCING PER ANSI Y14.5M, 1982.
2. CONTROLLING DIMENSION: MILLIMETER.
3. MAXIMUM LEAD THICKNESS INCLUDES LEAD FINISH THICKNESS. MINIMUM LEAD THICKNESS IS THE MINIMUM THICKNESS OF BASE MATERIAL.
4. DIMENSIONS A AND B DO NOT INCLUDE MOLD FLASH, PROTRUSIONS, OR GATE BURRS.

DIM	MILLIMETERS			INCHES		
	MIN	NOM	MAX	MIN	NOM	MAX
A	0.90	1.00	1.10	0.035	0.039	0.043
A1	0.01	0.06	0.10	0.001	0.002	0.004
b	0.25	0.38	0.50	0.010	0.014	0.020
c	0.10	0.18	0.26	0.004	0.007	0.010
D	2.90	3.00	3.10	0.114	0.118	0.122
E	1.30	1.50	1.70	0.051	0.059	0.067
e	0.85	0.95	1.05	0.034	0.037	0.041
L	0.20	0.40	0.60	0.008	0.016	0.024
HE	2.50	2.75	3.00	0.099	0.108	0.118
theta	0°	-	10°	0°	-	10°

### STYLE 1:

1. DRAIN
2. DRAIN
3. GATE
4. SOURCE
5. DRAIN
6. DRAIN

### SOLDERING FOOTPRINT\*



\*For additional information on our Pb-Free strategy and soldering details, please download the ON Semiconductor Soldering and Mounting Techniques Reference Manual, SOLDERRM/D.

ON Semiconductor and are registered trademarks of Semiconductor Components Industries, LLC (SCILLC). SCILLC reserves the right to make changes without further notice to any products herein. SCILLC makes no warranty, representation or guarantee regarding the suitability of its products for any particular purpose, nor does SCILLC assume any liability arising out of the application or use of any product or circuit, and specifically disclaims any and all liability, including without limitation special, consequential or incidental damages. "Typical" parameters which may be provided in SCILLC data sheets and/or specifications can and do vary in different applications and actual performance may vary over time. All operating parameters, including "Typicals" must be validated for each customer application by customer's technical experts. SCILLC does not convey any license under its patent rights nor the rights of others. SCILLC products are not designed, intended, or authorized for use as components in systems intended for surgical implant into the body, or other applications intended to support or sustain life, or for any other application in which the failure of the SCILLC product could create a situation where personal injury or death may occur. Should Buyer purchase or use SCILLC products for any such unintended or unauthorized application, Buyer shall indemnify and hold SCILLC and its officers, employees, subsidiaries, affiliates, and distributors harmless against all claims, costs, damages, and expenses, and reasonable attorney fees arising out of, directly or indirectly, any claim of personal injury or death associated with such unintended or unauthorized use, even if such claim alleges that SCILLC was negligent regarding the design or manufacture of the part. SCILLC is an Equal Opportunity/Affirmative Action Employer. This literature is subject to all applicable copyright laws and is not for resale in any manner.

### PUBLICATION ORDERING INFORMATION

**LITERATURE FULFILLMENT:**  
Literature Distribution Center for ON Semiconductor  
P.O. Box 61312, Phoenix, Arizona 85082-1312 USA  
**Phone:** 480-829-7710 or 800-344-3860 Toll Free USA/Canada  
**Fax:** 480-829-7709 or 800-344-3867 Toll Free USA/Canada  
**Email:** orderlit@onsemi.com

**N. American Technical Support:** 800-282-9855 Toll Free  
USA/Canada

**Japan:** ON Semiconductor, Japan Customer Focus Center  
2-9-1 Kamimeguro, Meguro-ku, Tokyo, Japan 153-0051  
**Phone:** 81-3-5773-3850

**ON Semiconductor Website:** <http://onsemi.com>

**Order Literature:** <http://www.onsemi.com/litorder>

For additional information, please contact your local Sales Representative.