

NTMKE4894N

Power MOSFET 25 V, 160 A, Single N-Channel, ICEPAK

Features

- Low Package Inductance
- Low $R_{DS(on)}$ to Minimize Conduction Losses
- Low Capacitance to Minimize Driver Losses
- Optimized Gate Charge to Minimize Switching Losses
- Dual Sided Cooling Capability
- Compatible with MX Footprint and Outline
- This is a Pb-Free Device

Applications

- CPU Power Delivery
- DC-DC Converters
- Optimized for Control FET

MAXIMUM RATINGS ($T_J = 25^\circ\text{C}$ unless otherwise stated)

Parameter	Symbol	Value	Unit
Drain-to-Source Voltage	V_{DSS}	25	V
Gate-to-Source Voltage	V_{GS}	± 20	V
Continuous Drain Current $R_{\theta JA}$ (Note 1)	I_D	$T_A = 25^\circ\text{C}$	33
		$T_A = 70^\circ\text{C}$	26.4
Power Dissipation $R_{\theta JA}$ (Note 1)	P_D	$T_A = 25^\circ\text{C}$	2.8
Continuous Drain Current $R_{\theta J-PCB}$ (Note 2)	I_D	$T_A = 25^\circ\text{C}$	160
		$T_A = 70^\circ\text{C}$	88.6
Power Dissipation $R_{\theta J-PCB}$ (Note 2)	P_D	$T_A = 25^\circ\text{C}$	65
Continuous Drain Current $R_{\theta JC}$ (Note 1)	I_D	$T_C = 25^\circ\text{C}$	170
		$T_C = 70^\circ\text{C}$	136
Power Dissipation $R_{\theta JC}$ (Note 1)	P_D	$T_C = 25^\circ\text{C}$	73.5
Pulsed Drain Current	$T_A = 25^\circ\text{C}, t_p = 10 \mu\text{s}$	I_{DM}	250
Current Limited by Package	$T_A = 25^\circ\text{C}$	I_{Dmax}	50
Operating Junction and Storage Temperature	T_J, T_{stg}		-40 to 150
			$^\circ\text{C}$
Source Current (Body Diode) (Note 1)	I_S	92	A
Drain to Source DV/DT	dV/dt	6.0	V/ns
Single Pulse Drain-to-Source Avalanche Energy ($T_J = 25^\circ\text{C}, V_{DD} = 25 \text{ V}, V_{GS} = 10 \text{ V}, I_L = 62 \text{ A}_{pk}, L = 0.3 \text{ mH}, R_G = 25 \Omega$)	E_{AS}	577	mJ
Lead Temperature for Soldering Purposes (1/8" from case for 10 s)	T_L	270	$^\circ\text{C}$

Stresses exceeding Maximum Ratings may damage the device. Maximum Ratings are stress ratings only. Functional operation above the Recommended Operating Conditions is not implied. Extended exposure to stresses above the Recommended Operating Conditions may affect device reliability.

1. Surfaced mounted on FR4 board using 1 sq-in pad, 1 oz Cu.
2. Measured with a T_J of approximately 90°C using 1 oz Cu board.
3. Surfaced mounted on FR4 board using 1 sq-in pad, 2 oz Cu.



ON Semiconductor®

<http://onsemi.com>

$V_{(BR)DSS}$	$R_{DS(ON) MAX}$	$I_D MAX$
25 V	1.7 m Ω @ 10 V	160 A
	2.4 m Ω @ 4.5 V	

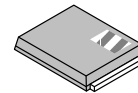

ICEPAK
E PAD
CASE 145AB

MARKING DIAGRAM



E4894 = Specific Device Code

A = Assembly Location

Y = Year

WW = Work Week

▪ = Pb-Free Package

(Note: Microdot may be in either location)

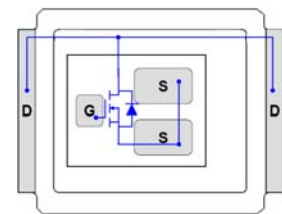
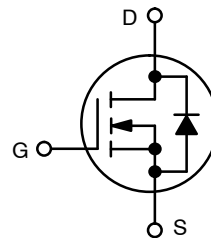

N-CHANNEL MOSFET

ORDERING INFORMATION

Device	Package	Shipping†
NTMKE4894NT1G	ICEPAK (Pb-Free)	1500/Tape & Reel
NTMKE4894NT3G	ICEPAK (Pb-Free)	5000/Tape & Reel

†For information on tape and reel specifications, including part orientation and tape sizes, please refer to our Tape and Reel Packaging Specification Brochure, BRD8011/D.

NTMKE4894N

THERMAL RESISTANCE MAXIMUM RATINGS

Parameter	Symbol	Value	Unit
Junction-to-Case (Drain) (Note 1)	$R_{\theta JC}$	1.7	°C/W
Junction-to-Ambient – Steady State (Note 1)	$R_{\theta JA}$	45	
Junction-to-Ambient – Steady State (Notes 2 and 3)	$R_{\theta JA}$	25	
Junction-to-PCB (Note 2)	$R_{\theta J-PCB}$	1.0	

ELECTRICAL CHARACTERISTICS ($T_J = 25^\circ\text{C}$ unless otherwise specified)

Parameter	Symbol	Test Condition	Min	Typ	Max	Unit
-----------	--------	----------------	-----	-----	-----	------

OFF CHARACTERISTICS

Drain-to-Source Breakdown Voltage	$V_{(BR)DSS}$	$V_{GS} = 0\text{ V}, I_D = 250\ \mu\text{A}$	25			V
Drain-to-Source Breakdown Voltage Temperature Coefficient	$V_{(BR)DSS}/T_J$			20		mV/°C
Zero Gate Voltage Drain Current	I_{DSS}	$V_{GS} = 0\text{ V}, V_{DS} = 20\text{ V}$	$T_J = 25^\circ\text{C}$		1.0	μA
			$T_J = 125^\circ\text{C}$		100	
Gate-to-Source Leakage Current	I_{GSS}	$V_{DS} = 0\text{ V}, V_{GS} = \pm 20\text{ V}$			± 100	nA

ON CHARACTERISTICS (Note 4)

Gate Threshold Voltage	$V_{GS(TH)}$	$V_{GS} = V_{DS}, I_D = 250\ \mu\text{A}$	1.4		2.4	V
Negative Threshold Temperature Coefficient	$V_{GS(TH)}/T_J$			5.9		mV/°C
Drain-to-Source On Resistance	$R_{DS(on)}$	$V_{GS} = 10\text{ V}, I_D = 30\text{ A}$		1.3	1.7	m Ω
		$V_{GS} = 4.5\text{ V}, I_D = 30\text{ A}$		1.9	2.4	
Forward Transconductance	g_{FS}	$V_{DS} = 13\text{ V}, I_D = 27\text{ A}$	100	139		S

CHARGES, CAPACITANCES AND GATE RESISTANCE

Input Capacitance	C_{iss}	$V_{GS} = 0\text{ V}, f = 1.0\text{ MHz}, V_{DS} = 13\text{ V}$		7130		pF
Output Capacitance	C_{oss}			1605		
Reverse Transfer Capacitance	C_{rss}			830		
Total Gate Charge	$Q_{G(TOT)}$	$V_{GS} = 4.5\text{ V}, V_{DS} = 13\text{ V}, I_D = 27\text{ A}$		51.3		nC
Threshold Gate Charge	$Q_{G(TH)}$			6.0		
Gate-to-Source Charge	Q_{GS}			19.2		
Gate-to-Drain Charge	Q_{GD}			18.6		
Total Gate Charge	$Q_{G(TOT)}$	$V_{GS} = 10\text{ V}, V_{DS} = 13\text{ V}, I_D = 27\text{ A}$		100.8		nC

SWITCHING CHARACTERISTICS (Note 5)

Turn-On Delay Time	$t_{d(on)}$	$V_{GS} = 4.5\text{ V}, V_{DS} = 13\text{ V}, I_D = 27\text{ A}, R_G = 1.8\ \Omega$		25		ns
Rise Time	t_r			30		
Turn-Off Delay Time	$t_{d(off)}$			40		
Fall Time	t_f			12		

DRAIN-SOURCE DIODE CHARACTERISTICS

Forward Diode Voltage	V_{SD}	$V_{GS} = 0\text{ V}, I_S = 27\text{ A}$	$T_J = 25^\circ\text{C}$	0.8	1.0	V
			$T_J = 125^\circ\text{C}$	0.65		
Reverse Recovery Time	t_{RR}	$V_{GS} = 0\text{ V}, dI_S/dt = 200\text{ A}/\mu\text{s}, I_S = 27\text{ A}$		50		ns
Charge Time	t_a			21		
Discharge Time	t_b			29		
Reverse Recovery Charge	Q_{RR}			74		nC

PACKAGE PARASITIC VALUES

Gate Resistance	R_G	$T_A = 25^\circ\text{C}$		0.5	1.5	Ω
-----------------	-------	--------------------------	--	-----	-----	----------

4. Pulse Test: pulse width = 300 μs , duty cycle $\leq 2\%$.

5. Switching characteristics are independent of operating junction temperatures.

TYPICAL CHARACTERISTICS

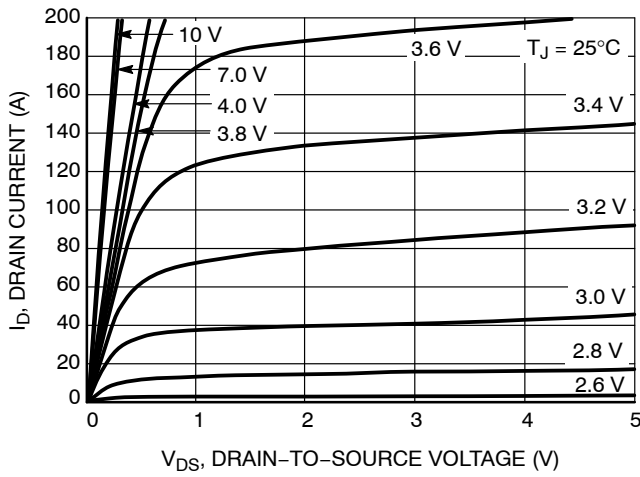

Figure 1. On-Region Characteristics

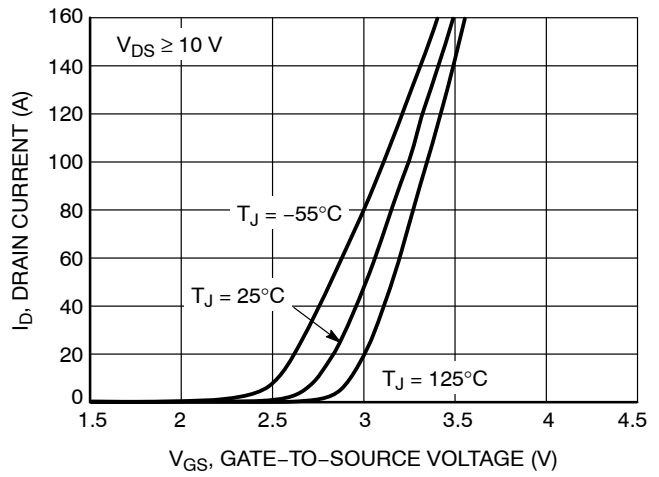

Figure 2. Transfer Characteristics

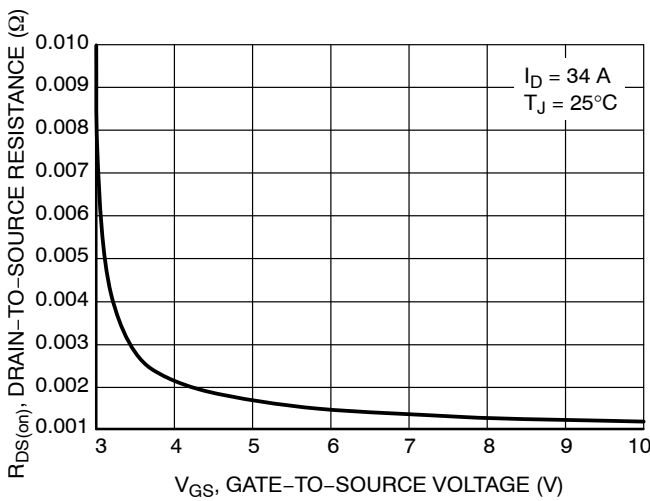

Figure 3. On-Resistance vs. Gate-to-Source Voltage

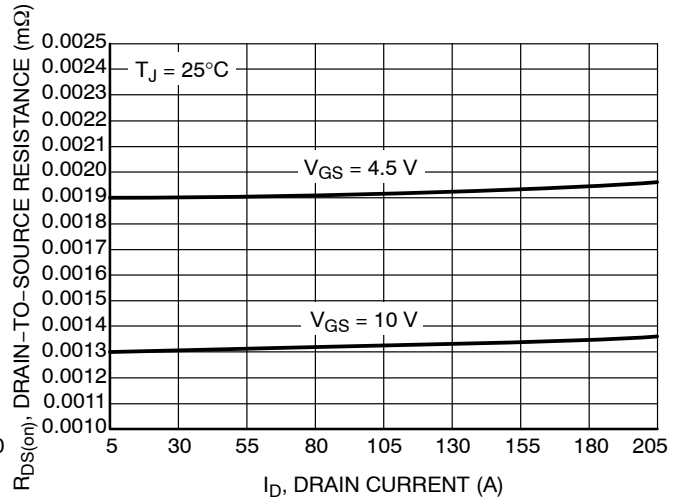

Figure 4. On-Resistance vs. Drain Current and Gate Voltage

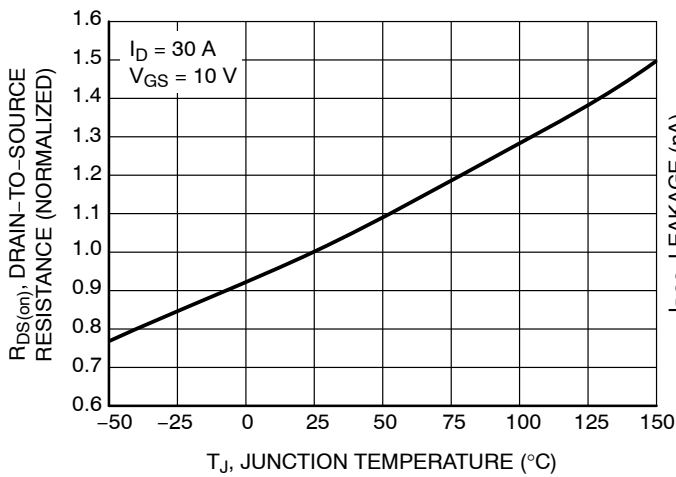

Figure 5. On-Resistance Variation with Temperature

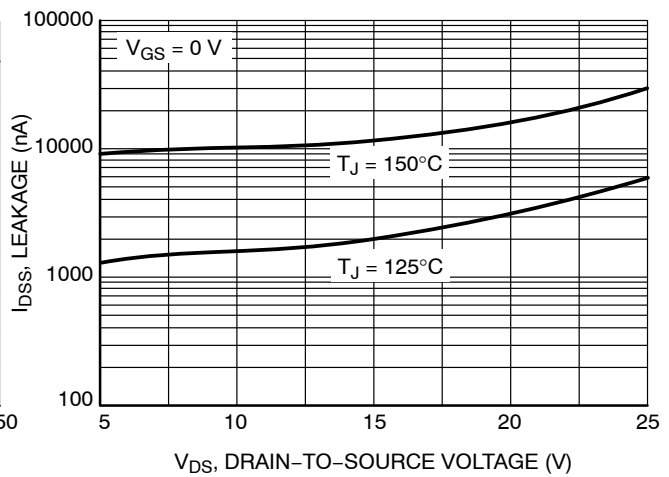

Figure 6. Drain-to-Source Leakage Current vs. Voltage

TYPICAL CHARACTERISTICS

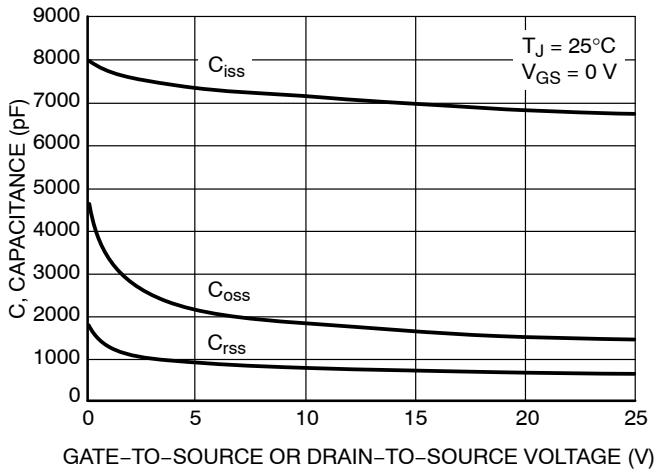

Figure 7. Capacitance Variation

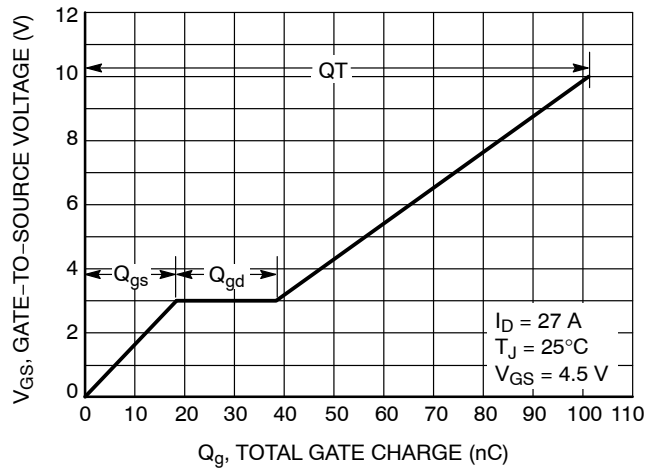

Figure 8. Gate-to-Source and Drain-to-Source Voltage vs. Total Charge

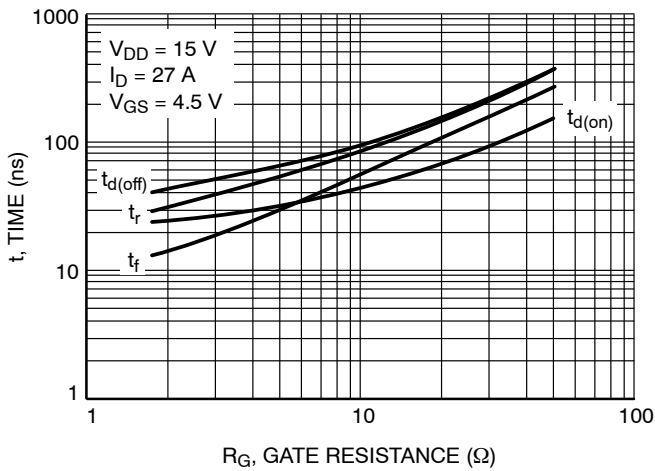

Figure 9. Resistive Switching Time Variation vs. Gate Resistance

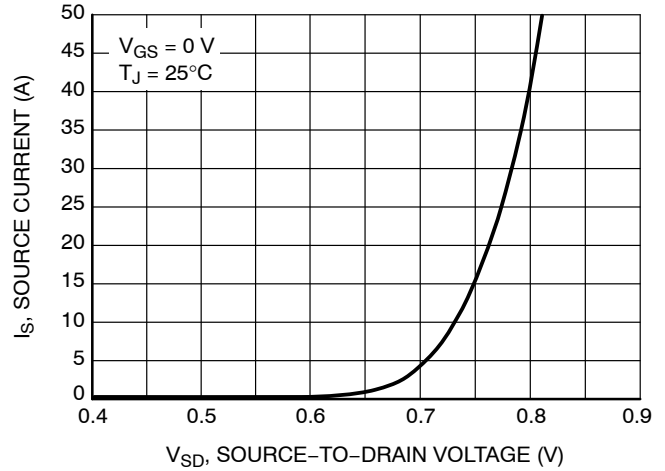

Figure 10. Diode Forward Voltage vs. Current

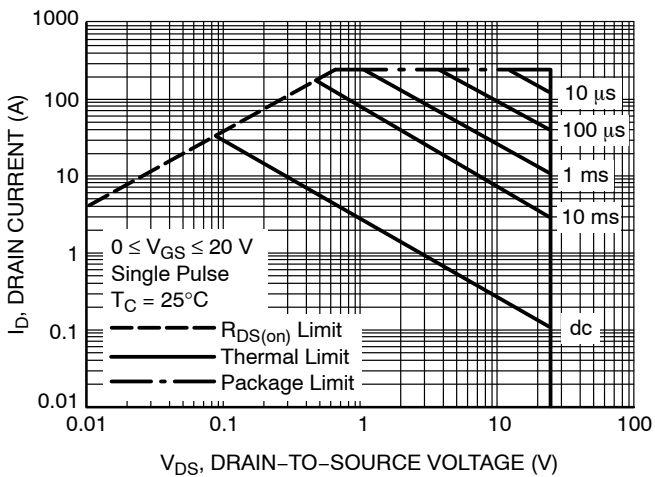

Figure 11. Maximum Rated Forward Biased Safe Operating Area

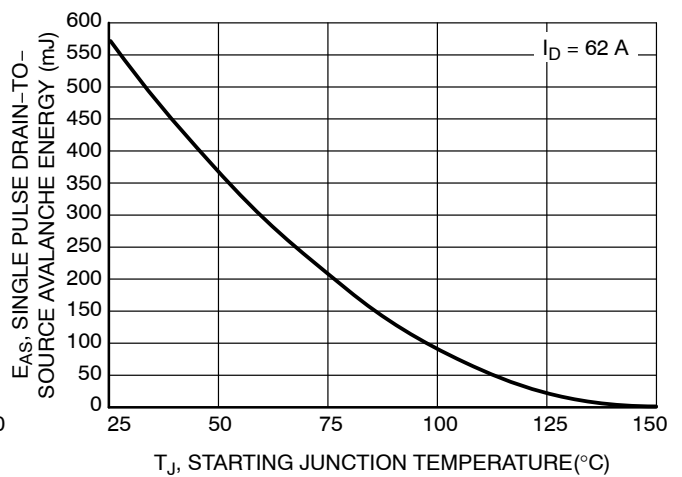

Figure 12. Maximum Avalanche Energy vs. Starting Junction Temperature

NTMKE4894N

TYPICAL CHARACTERISTICS

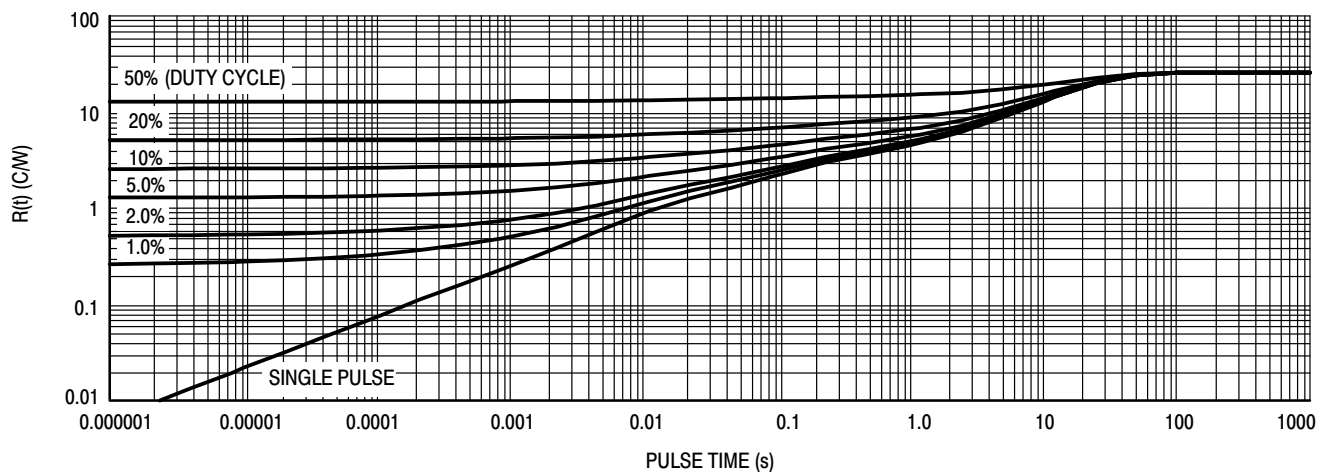
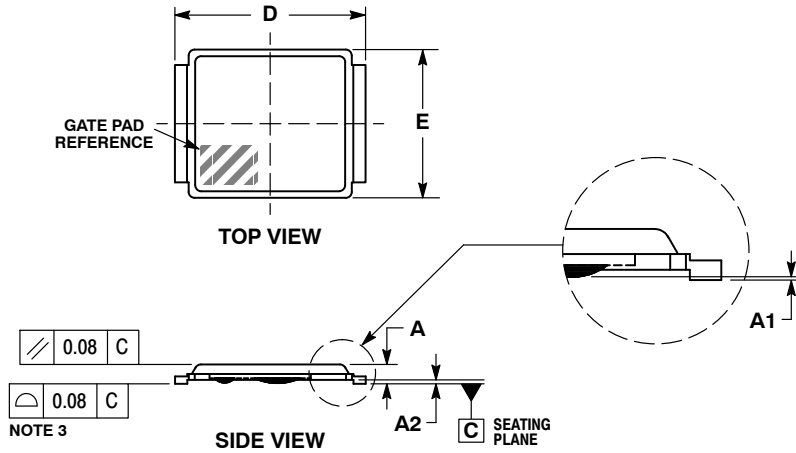

Figure 13. Thermal Impedance

NTMKE4894N

PACKAGE DIMENSIONS

ICEPAK 6.3x4.9 – E PAD
CASE 145AB-01
ISSUE 0



NOTES:

1. DIMENSIONING AND TOLERANCING PER ASME Y14.5M, 1994.
2. CONTROLLING DIMENSION: MILLIMETERS.
3. COPLANARITY APPLIES TO THE FLANGES OF LEADFRAME ONLY.

DIM	MILLIMETERS	
	MIN	MAX
A	0.61	0.68
A1	0.02	0.08
A2	0.08	0.17
D	6.25	6.35
D2	0.35	0.45
D3	1.38	1.42
D4	0.68	0.72
E	4.80	5.05
E2	3.85	3.95
E3	0.80	0.84
E4	0.68	0.72
F	0.94 BSC	
G	2.54 BSC	
H	0.38	0.42

SOLDERING FOOTPRINT*

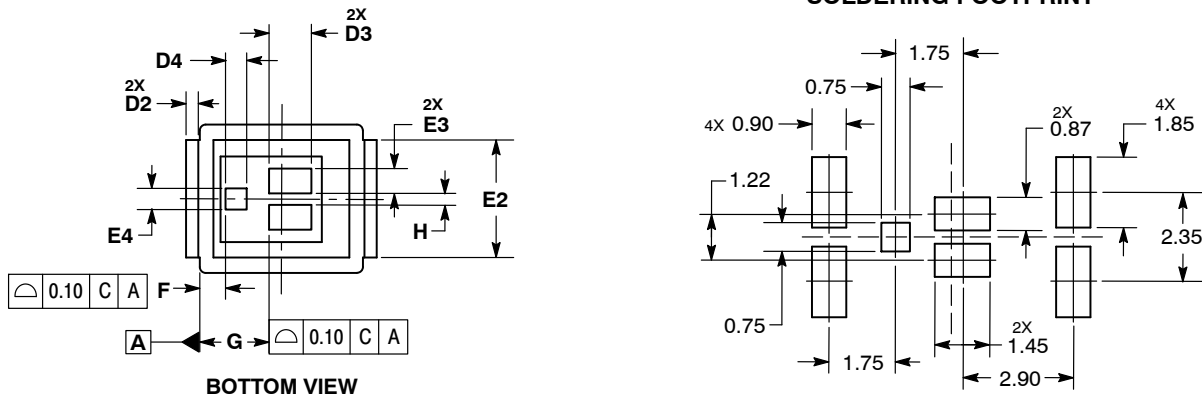

DIMENSIONS: MILLIMETERS

*For additional information on our Pb-Free strategy and soldering details, please download the ON Semiconductor Soldering and Mounting Techniques Reference Manual, SOLDERRM/D.

ON Semiconductor and are registered trademarks of Semiconductor Components Industries, LLC (SCILLC). SCILLC reserves the right to make changes without further notice to any products herein. SCILLC makes no warranty, representation or guarantee regarding the suitability of its products for any particular purpose, nor does SCILLC assume any liability arising out of the application or use of any product or circuit, and specifically disclaims any and all liability, including without limitation special, consequential or incidental damages. "Typical" parameters which may be provided in SCILLC data sheets and/or specifications can and do vary in different applications and actual performance may vary over time. All operating parameters, including "Typicals" must be validated for each customer application by customer's technical experts. SCILLC does not convey any license under its patent rights nor the rights of others. SCILLC products are not designed, intended, or authorized for use as components in systems intended for surgical implant into the body, or other applications intended to support or sustain life, or for any other application in which the failure of the SCILLC product could create a situation where personal injury or death may occur. Should Buyer purchase or use SCILLC products for any such unintended or unauthorized application, Buyer shall indemnify and hold SCILLC and its officers, employees, subsidiaries, affiliates, and distributors harmless against all claims, costs, damages, and expenses, and reasonable attorney fees arising out of, directly or indirectly, any claim of personal injury or death associated with such unintended or unauthorized use, even if such claim alleges that SCILLC was negligent regarding the design or manufacture of the part. SCILLC is an Equal Opportunity/Affirmative Action Employer. This literature is subject to all applicable copyright laws and is not for resale in any manner.

PUBLICATION ORDERING INFORMATION

LITERATURE FULFILLMENT:
Literature Distribution Center for ON Semiconductor
P.O. Box 5163, Denver, Colorado 80217 USA
Phone: 303-675-2175 or 800-344-3860 Toll Free USA/Canada
Fax: 303-675-2176 or 800-344-3867 Toll Free USA/Canada
Email: orderlit@onsemi.com

N. American Technical Support: 800-282-9855 Toll Free
USA/Canada
Europe, Middle East and Africa Technical Support:
Phone: 421 33 790 2910
Japan Customer Focus Center
Phone: 81-3-5773-3850

ON Semiconductor Website: www.onsemi.com

Order Literature: <http://www.onsemi.com/orderlit>

For additional information, please contact your local Sales Representative