

NTND31215CZ

Small Signal MOSFET

20 V, Complementary 0.65 mm x 0.90 mm x 0.4 mm XLLGA6 Package

Features

- Advanced Trench Complementary MOSFET
- Offers a Low $R_{DS(ON)}$ Solution in the Ultra Small 0.65 mm x 0.90 mm Package
- These Devices are Pb-Free, Halogen Free/BFR Free and are RoHS Compliant

Applications

- Small Signal Load Switch with Level Shift
- Analog Switch
- High Speed Interfacing
- Optimized for Power Management in Ultra Portable Products

MAXIMUM RATINGS ($T_J = 25^\circ\text{C}$ unless otherwise specified)

Parameter		Symbol	Value	Unit	
Drain-to-Source Voltage	NMOS	V_{DSS}	20	V	
	PMOS		-20		
Gate-to-Source Voltage	NMOS	V_{GSS}	± 8	V	
	PMOS		± 8		
N-Channel Continuous Drain Current (Note 1)	Steady State	$T_A = 25^\circ\text{C}$	I_D	220	mA
		$T_A = 85^\circ\text{C}$		158	
	$t \leq 5 \text{ s}$	$T_A = 25^\circ\text{C}$		253	
P-Channel Continuous Drain Current (Note 1)	Steady State	$T_A = 25^\circ\text{C}$	I_D	-127	mA
		$T_A = 85^\circ\text{C}$		-91	
	$t \leq 5 \text{ s}$	$T_A = 25^\circ\text{C}$		-146	
Power Dissipation (Note 1)	Steady State	$T_A = 25^\circ\text{C}$	P_D	125	mW
		$t \leq 5 \text{ s}$		166	
Pulsed Drain Current	NMOS	$t_p = 10 \mu\text{s}$	I_{DM}	846	mA
	PMOS			-488	
Source Current (Body Diode)		I_S	200	mA	
			-200		
Operating Junction and Storage Temperature		T_J, T_{STG}	-55 to 150	$^\circ\text{C}$	
Lead Temperature for Soldering Purposes (1/8" from case for 10 s)		T_L	260	$^\circ\text{C}$	

Stresses exceeding those listed in the Maximum Ratings table may damage the device. If any of these limits are exceeded, device functionality should not be assumed, damage may occur and reliability may be affected.

1. Surface-mounted on FR4 board using the minimum recommended pad size, 1 oz Cu.



ON Semiconductor®

www.onsemi.com

$V_{(BR)DSS}$	$R_{DS(ON)}$ MAX	I_D Max
N-Channel 20 V	1.5 Ω @ 4.5 V	220 mA
	2.0 Ω @ 2.5 V	
	3.0 Ω @ 1.8 V	
	4.5 Ω @ 1.5 V	
P-Channel -20 V	5.0 Ω @ -4.5 V	-127 mA
	6.0 Ω @ -2.5 V	
	7.0 Ω @ -1.8 V	
	10.0 Ω @ -1.5 V	

DEVICE SYMBOL

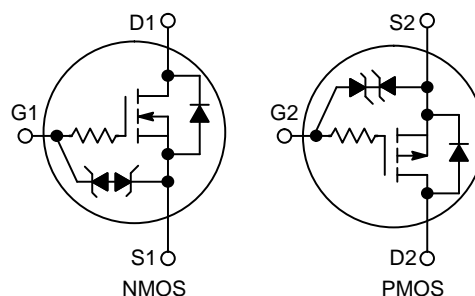

XLLGA6
Case 713AC

MARKING DIAGRAM

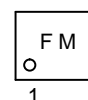

F = Specific Device Code
M = Date Code

PINOUT DIAGRAM

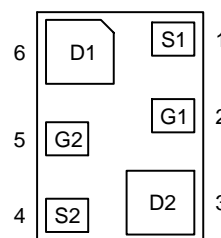

(Bottom View)

ORDERING INFORMATION

See detailed ordering and shipping information on page 3 of this data sheet.

NTND31215CZ

THERMAL RESISTANCE RATINGS

Parameter	Symbol	Max	Unit
Junction-to-Ambient (Note 2) Steady State $t \leq 5$ s	$R_{\theta JA}$	998 751	$^{\circ}\text{C/W}$

2. Surface-mounted on FR4 board using 1 in sq pad size (Cu area = 1.127 in sq), 1 oz copper

ELECTRICAL CHARACTERISTICS ($T_J = 25^{\circ}\text{C}$ unless otherwise specified)

Parameter	Symbol	FET	Test Condition	Min	Typ	Max	Unit
-----------	--------	-----	----------------	-----	-----	-----	------

OFF CHARACTERISTICS

Drain-to-Source Breakdown Voltage	$V_{(BR)DSS}$	N	$V_{GS} = 0$ V, $I_D = 250$ μA	20			V
		P	$V_{GS} = 0$ V, $I_D = -250$ μA	-20			
Zero Gate Voltage Drain Current	I_{DSS}	N	$V_{GS} = 0$ V, $V_{DS} = 5$ V	$T_J = 25^{\circ}\text{C}$		50	nA
				$T_J = 85^{\circ}\text{C}$		200	
			$V_{GS} = 0$ V, $V_{DS} = 16$ V	$T_J = 25^{\circ}\text{C}$		100	
		P	$V_{GS} = 0$ V, $V_{DS} = -5$ V	$T_J = 25^{\circ}\text{C}$		-50	
				$T_J = 85^{\circ}\text{C}$		-200	
			$V_{GS} = 0$ V, $V_{DS} = -16$ V	$T_J = 25^{\circ}\text{C}$		-100	
Gate-to-Source Leakage Current	I_{GSS}	N	$V_{GS} = 0$ V, $V_{DS} = \pm 5$ V			± 100	nA
		P	$V_{GS} = 0$ V, $V_{DS} = \pm 5$ V			± 100	

ON CHARACTERISTICS

Gate Threshold Voltage	$V_{GS(TH)}$	N	$V_{GS} = V_{DS}$, $I_D = 250$ μA	0.4		1.0	V
		P	$V_{GS} = V_{DS}$, $I_D = -250$ μA	-0.4		-1.0	
Drain-to-Source On Resistance	$R_{DS(ON)}$	N	$V_{GS} = 4.5$ V, $I_D = 100$ mA		0.8	1.5	Ω
			$V_{GS} = 2.5$ V, $I_D = 50$ mA		1.1	2.0	
			$V_{GS} = 1.8$ V, $I_D = 20$ mA		1.4	3.0	
			$V_{GS} = 1.5$ V, $I_D = 10$ mA		1.8	4.5	
		P	$V_{GS} = -4.5$ V, $I_D = -100$ mA		2.1	5.0	
			$V_{GS} = -2.5$ V, $I_D = -50$ mA		2.7	6.0	
			$V_{GS} = -1.8$ V, $I_D = -20$ mA		3.6	7.0	
			$V_{GS} = -1.5$ V, $I_D = -10$ mA		4.2	10.0	
Forward Transconductance	g_{FS}	N	$V_{DS} = 5$ V, $I_D = 125$ mA		0.48		S
		P	$V_{DS} = -5$ V, $I_D = -125$ mA		0.35		
Forward Diode Voltage	V_{SD}	N	$V_{GS} = 0$ V, $I_S = 10$ mA		0.6	1.0	V
		P	$V_{GS} = 0$ V, $I_S = -10$ mA		-0.6	-1.0	

3. Switching characteristics are independent of operating junction temperatures.

Product parametric performance is indicated in the Electrical Characteristics for the listed test conditions, unless otherwise noted. Product performance may not be indicated by the Electrical Characteristics if operated under different conditions.

NTND31215CZ

ELECTRICAL CHARACTERISTICS (T_J = 25°C unless otherwise specified)

Parameter	Symbol	FET	Test Condition	Min	Typ	Max	Unit
CAPACITANCES							
Input Capacitance	C _{ISS}	N	V _{GS} = 0 V, f = 1 MHz, V _{DS} = 15 V		12.3		pF
Output Capacitance	C _{OSS}				3.4		
Reverse Capacitance	C _{RSS}				2.5		
Input Capacitance	C _{ISS}	P	V _{GS} = 0 V, f = 1 MHz, V _{DS} = -15 V		12.8		
Output Capacitance	C _{OSS}				2.8		
Reverse Capacitance	C _{RSS}				2.0		

SWITCHING CHARACTERISTICS, V_{GS} = 4.5 V

Turn-On Delay Time	t _{d(ON)}	N	V _{GS} = 4.5 V, V _{DS} = 15 V, I _D = 200 mA, R _G = 2 Ω		16.5		ns
Rise Time	t _r				25.5		
Turn-Off Delay Time	t _{d(OFF)}				142		
Fall Time	t _f				80		
Turn-On Delay Time	t _{d(ON)}	P	V _{GS} = -4.5 V, V _{DS} = -15 V, I _D = -200 mA, R _G = 2 Ω		37		
Rise Time	t _r				71		
Turn-Off Delay Time	t _{d(OFF)}				280		
Fall Time	t _f				171		

3. Switching characteristics are independent of operating junction temperatures.

Product parametric performance is indicated in the Electrical Characteristics for the listed test conditions, unless otherwise noted. Product performance may not be indicated by the Electrical Characteristics if operated under different conditions.

ORDERING INFORMATION

Device	Package	Shipping†
NTND31215CZTAG	XLLGA6 (Pb-Free)	8000 / Tape & Reel

†For information on tape and reel specifications, including part orientation and tape sizes, please refer to our Tape and Reel Packaging Specifications Brochure, BRD8011/D.

TYPICAL CHARACTERISTICS – P-CHANNEL

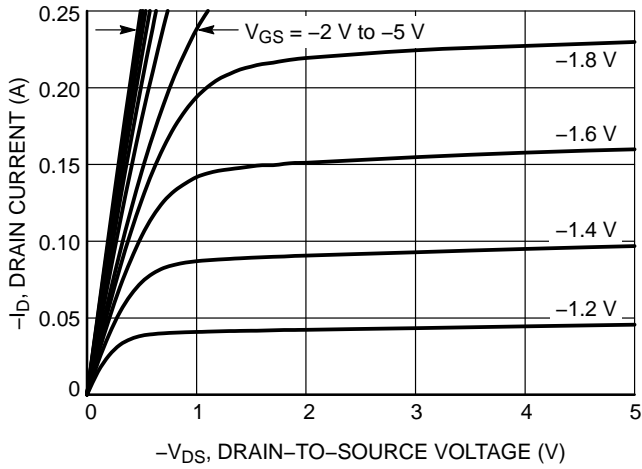

Figure 1. On-Region Characteristics

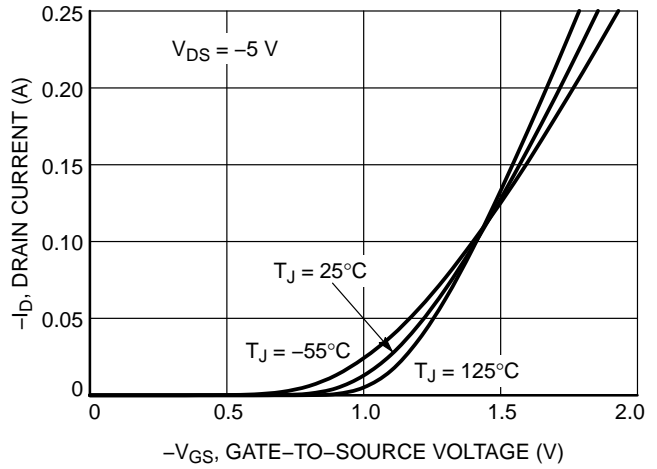

Figure 2. Transfer Characteristics

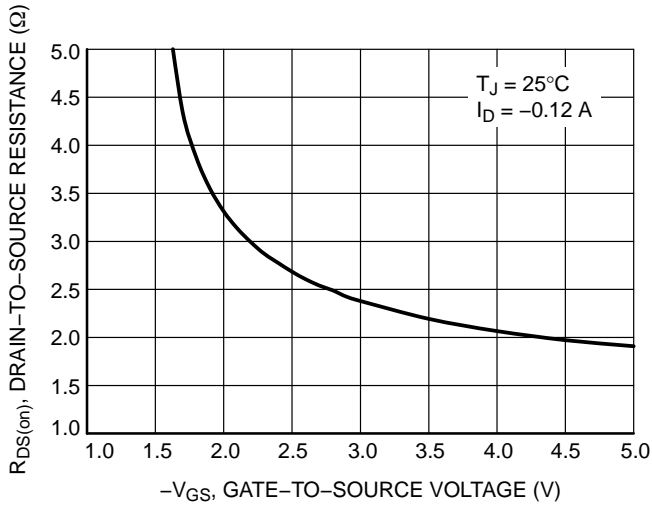

Figure 3. On-Resistance vs. Gate-to-Source Voltage

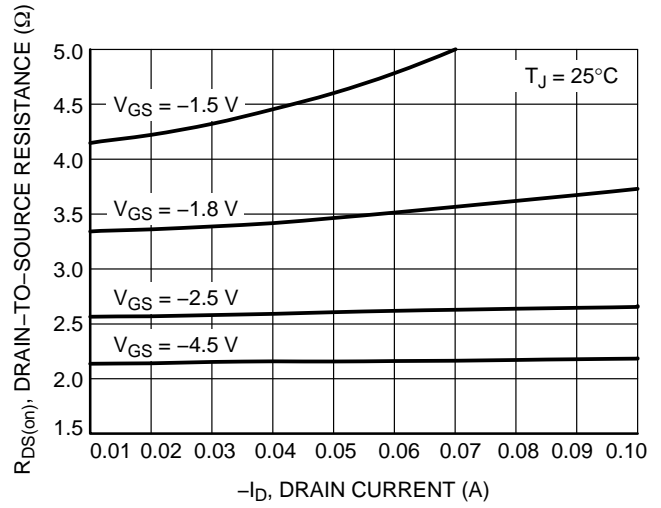

Figure 4. On-Resistance vs. Drain Current and Gate Voltage

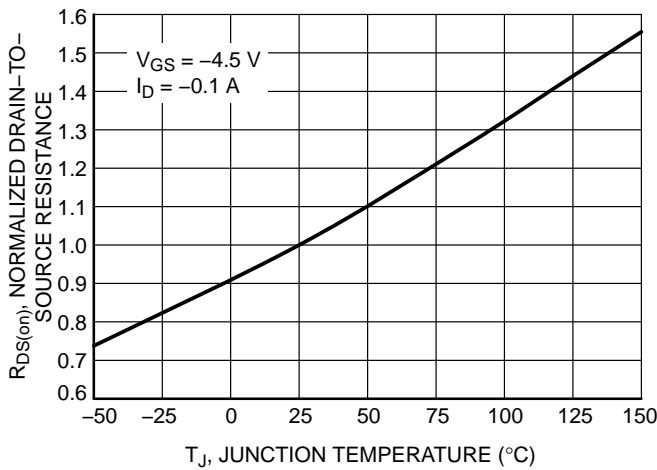

Figure 5. On-Resistance Variation with Temperature

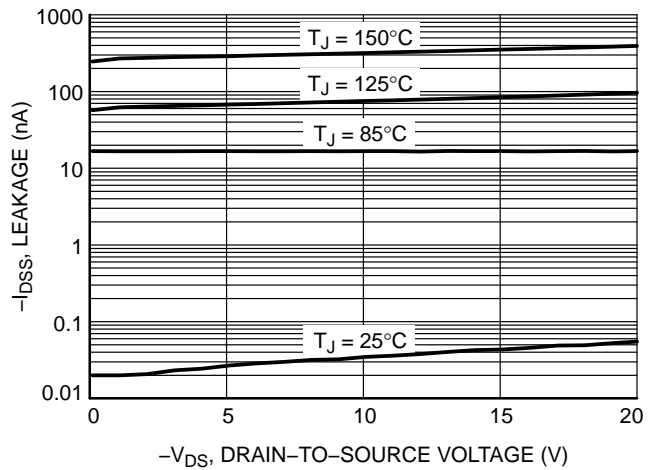

Figure 6. Drain-to-Source Leakage Current vs. Voltage

NTND31215CZ

TYPICAL CHARACTERISTICS – P-CHANNEL

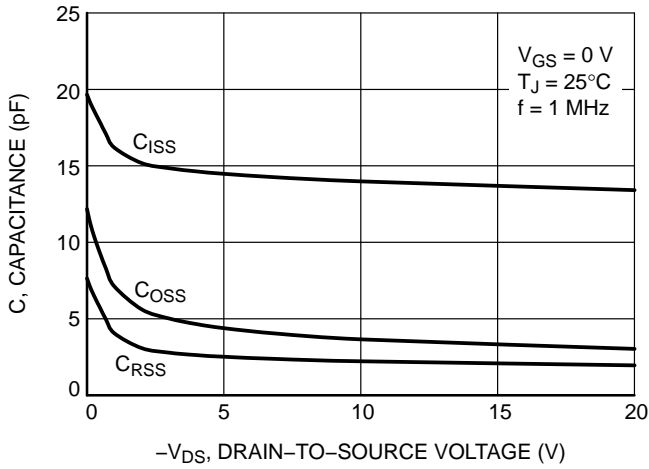

Figure 7. Capacitance Variation

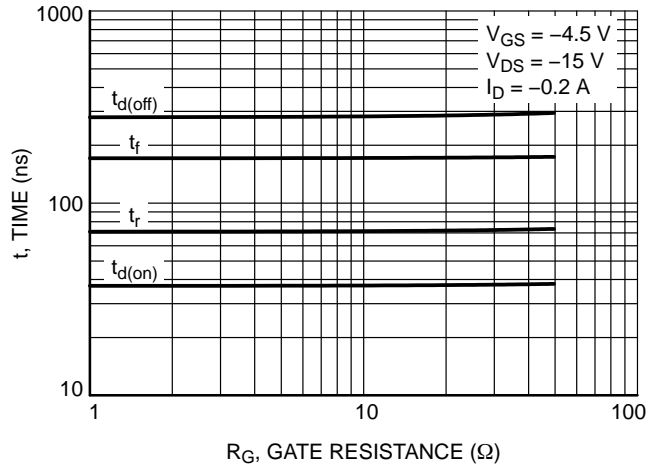

Figure 8. Resistive Switching Time Variation vs. Gate Resistance

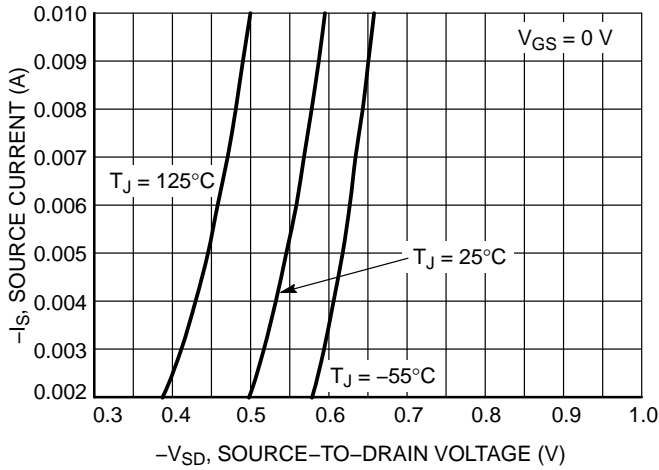

Figure 9. Diode Forward Voltage vs. Current

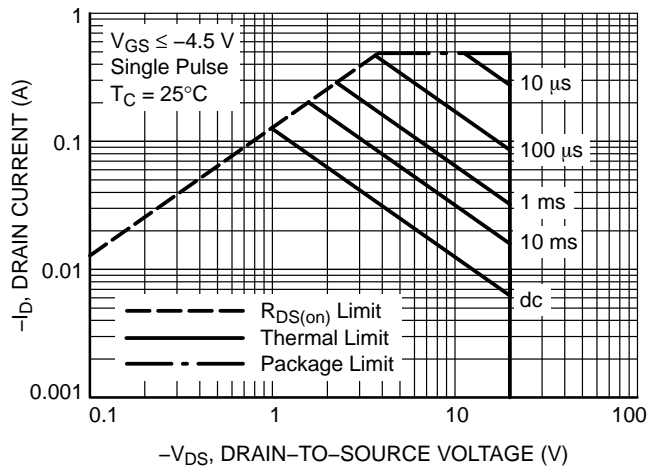

Figure 10. Maximum Rated Forward Biased Safe Operating Area

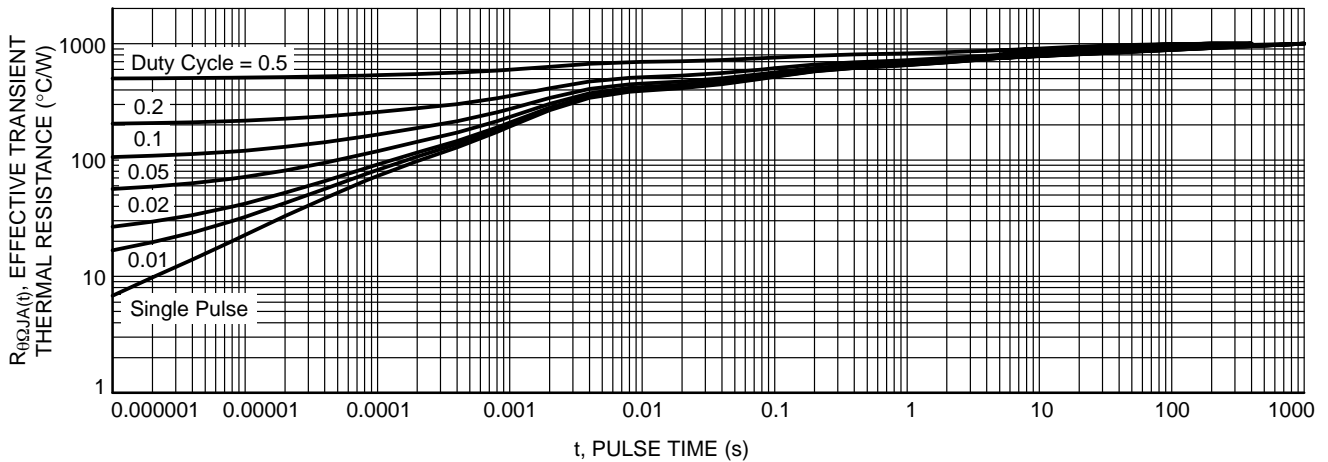

Figure 11. Thermal Response

NTND31215CZ

TYPICAL CHARACTERISTICS – N-CANNEL

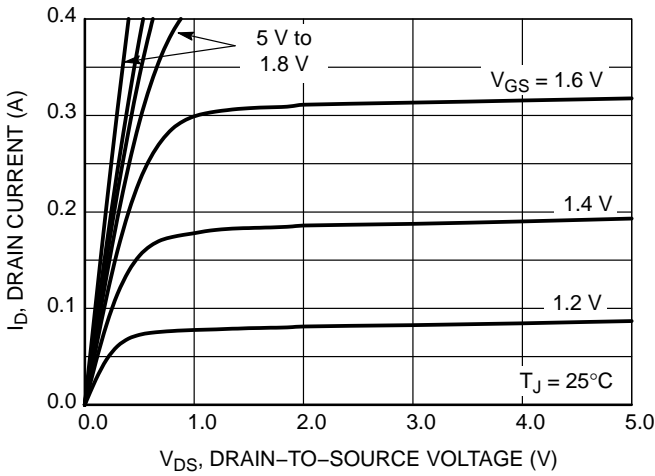

Figure 12. On-Region Characteristics

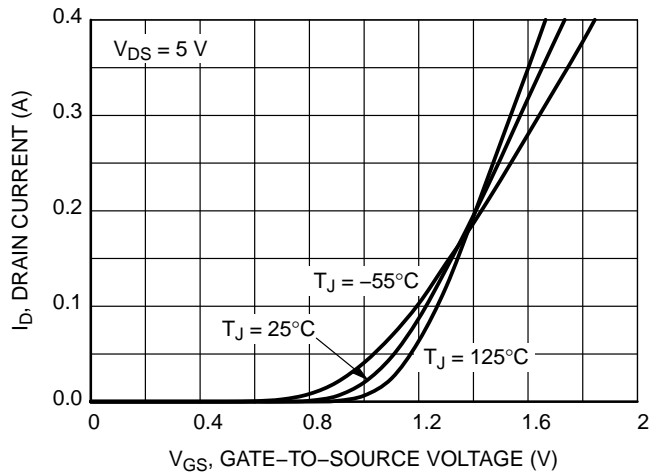

Figure 13. Transfer Characteristics

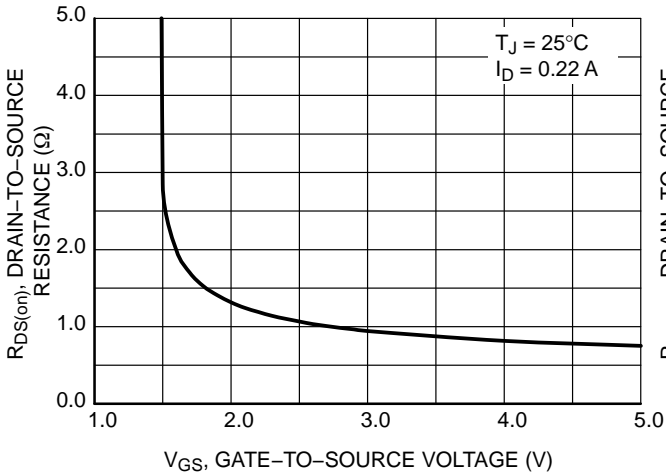

Figure 14. On-Resistance vs. Gate-to-Source Voltage

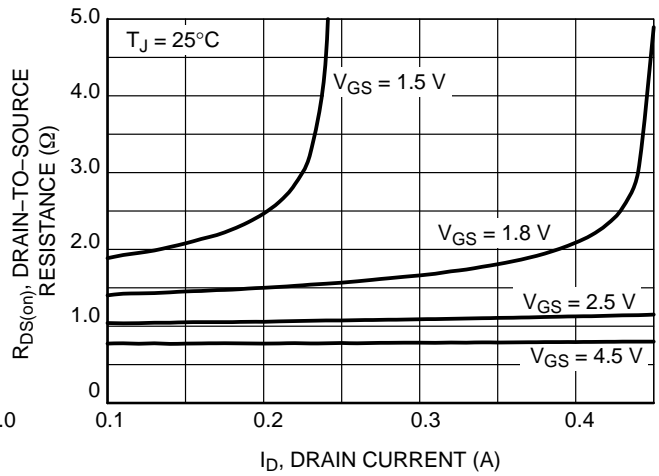

Figure 15. On-Resistance vs. Drain Current and Gate Voltage

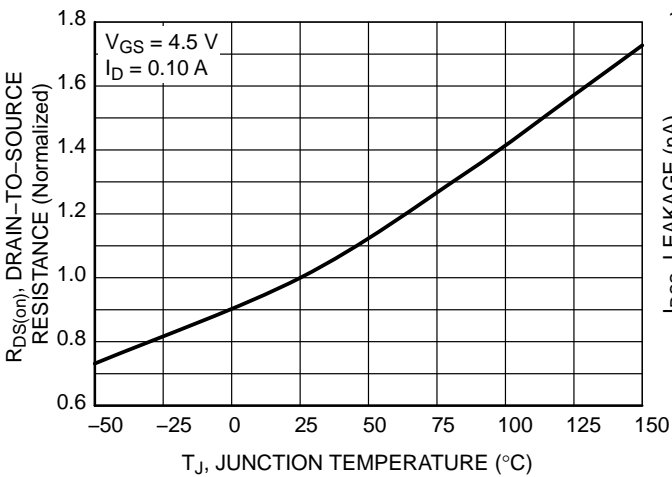

Figure 16. On-Resistance Variation with Temperature

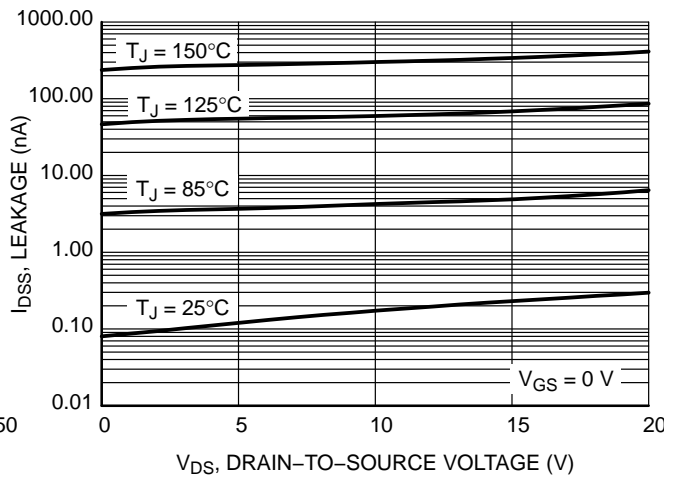

Figure 17. Drain-to-Source Leakage Current vs. Voltage

NTND31215CZ

TYPICAL CHARACTERISTICS – N-CANNEL

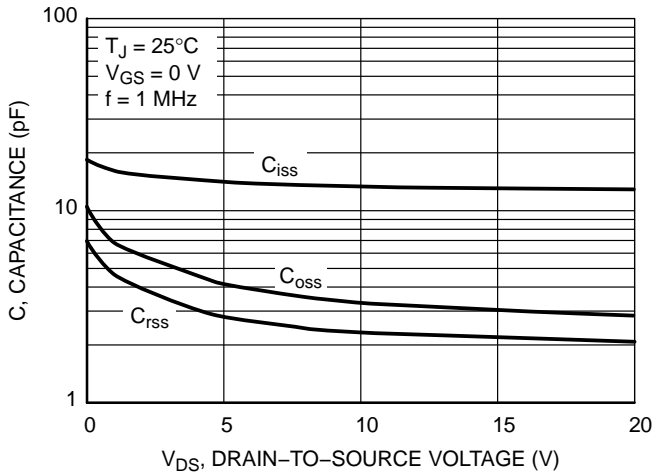

Figure 18. Capacitance Variation

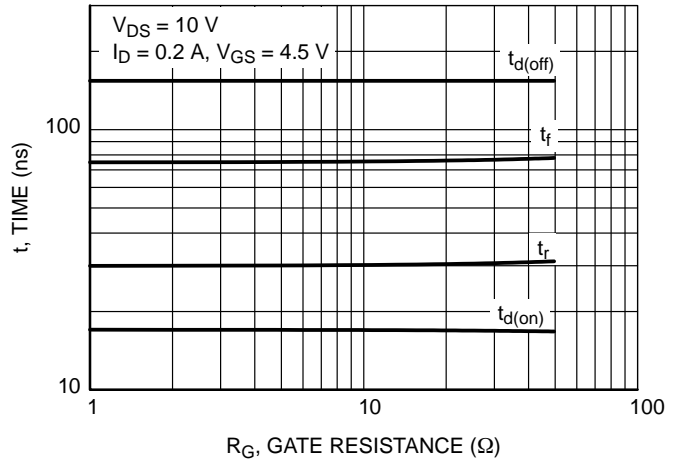

Figure 19. Resistive Switching Time Variation vs. Gate Resistance

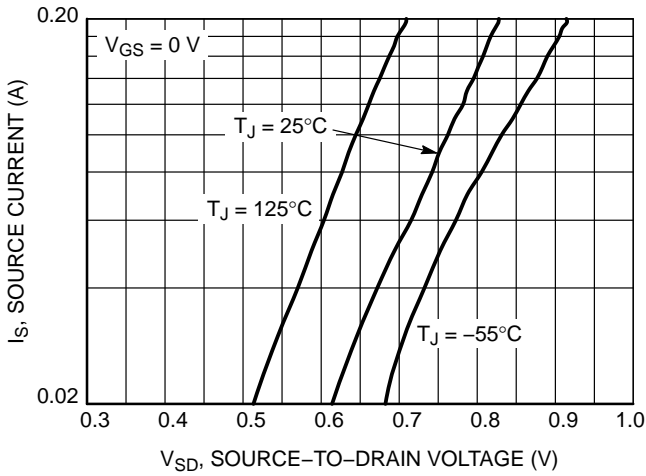

Figure 20. Diode Forward Voltage vs. Current

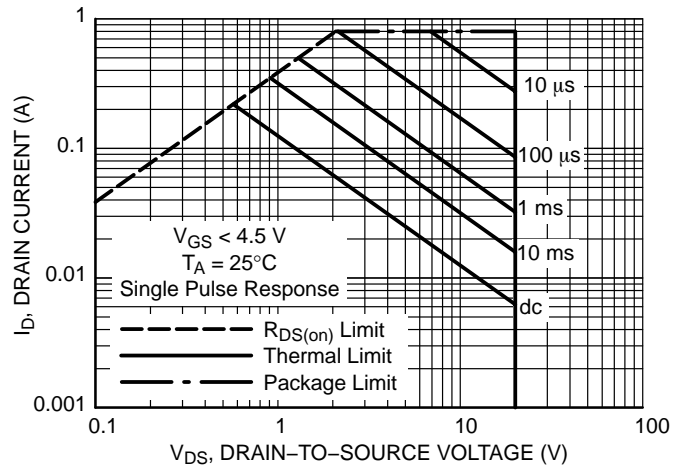

Figure 21. Maximum Rated Forward Biased Safe Operating Area

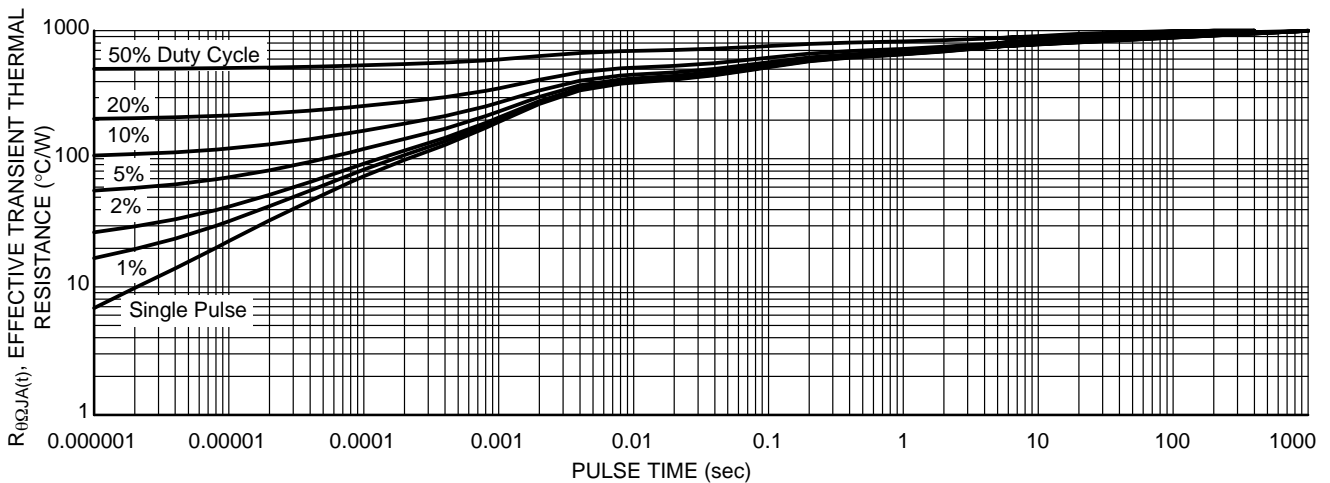
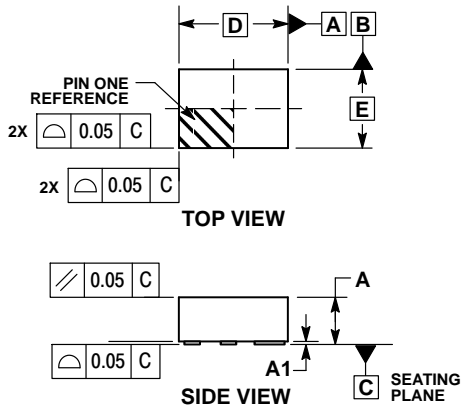

Figure 22. Thermal Response

NTND31215CZ

PACKAGE DIMENSIONS

XLLGA6 0.90x0.65
CASE 713AC
ISSUE O



NOTES:

1. DIMENSIONING AND TOLERANCING PER ASME Y14.5M, 1994.
2. CONTROLLING DIMENSION: MILLIMETERS.
3. POSITIONAL TOLERANCE APPLIES TO ALL SIX LEADS.

DIM	MILLIMETERS	
	MIN	MAX
A	0.340	0.440
A1	0.000	0.050
b	0.200	0.300
b2	0.080	0.180
D	0.900 BSC	
E	0.650 BSC	
e	0.295 BSC	
e1	0.340 BSC	
e2	0.300 BSC	
e3	0.208 BSC	
e4	0.158 BSC	
L	0.215	0.315
L2	0.115	0.215

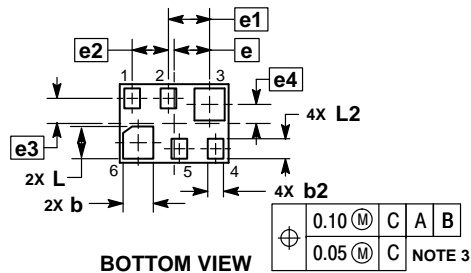

RECOMMENDED SOLDERING FOOTPRINT*

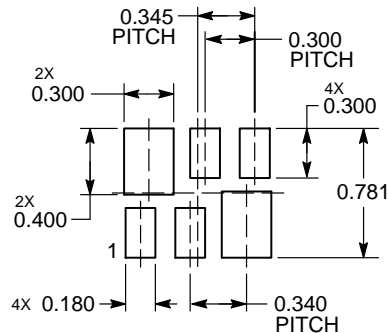

DIMENSIONS: MILLIMETERS

*For additional information on our Pb-Free strategy and soldering details, please download the ON Semiconductor Soldering and Mounting Techniques Reference Manual, SOLDERRM/D.

ON Semiconductor and the are registered trademarks of Semiconductor Components Industries, LLC (SCILLC) or its subsidiaries in the United States and/or other countries. SCILLC owns the rights to a number of patents, trademarks, copyrights, trade secrets, and other intellectual property. A listing of SCILLC's product/patent coverage may be accessed at www.onsemi.com/site/pdf/Patent-Marking.pdf. SCILLC reserves the right to make changes without further notice to any products herein. SCILLC makes no warranty, representation or guarantee regarding the suitability of its products for any particular purpose, nor does SCILLC assume any liability arising out of the application or use of any product or circuit, and specifically disclaims any and all liability, including without limitation special, consequential or incidental damages. "Typical" parameters which may be provided in SCILLC data sheets and/or specifications can and do vary in different applications and actual performance may vary over time. All operating parameters, including "Typicals" must be validated for each customer application by customer's technical experts. SCILLC does not convey any license under its patent rights nor the rights of others. SCILLC products are not designed, intended, or authorized for use as components in systems intended for surgical implant into the body, or other applications intended to support or sustain life, or for any other application in which the failure of the SCILLC product could create a situation where personal injury or death may occur. Should Buyer purchase or use SCILLC products for any such unintended or unauthorized application, Buyer shall indemnify and hold SCILLC and its officers, employees, subsidiaries, affiliates, and distributors harmless against all claims, costs, damages, and expenses, and reasonable attorney fees arising out of, directly or indirectly, any claim of personal injury or death associated with such unintended or unauthorized use, even if such claim alleges that SCILLC was negligent regarding the design or manufacture of the part. SCILLC is an Equal Opportunity/Affirmative Action Employer. This literature is subject to all applicable copyright laws and is not for resale in any manner.

PUBLICATION ORDERING INFORMATION

LITERATURE FULFILLMENT:
Literature Distribution Center for ON Semiconductor
19521 E. 32nd Pkwy, Aurora, Colorado 80011 USA
Phone: 303-675-2175 or 800-344-3860 Toll Free USA/Canada
Fax: 303-675-2176 or 800-344-3867 Toll Free USA/Canada
Email: orderlit@onsemi.com

N. American Technical Support: 800-282-9855 Toll Free
USA/Canada
Europe, Middle East and Africa Technical Support:
Phone: 421 33 790 2910
Japan Customer Focus Center
Phone: 81-3-5817-1050

ON Semiconductor Website: www.onsemi.com
Order Literature: <http://www.onsemi.com/orderlit>

For additional information, please contact your local Sales Representative