

# NTNS31350PZ

## Product Preview

### Small Signal MOSFET

-20 V, -127 mA, Single P-Channel, XDFN3  
0.62 x 0.42 x 0.4 mm Package

#### Features

- Low Profile Ultra Small Package, XDFN3 (0.62 x 0.42 x 0.4 mm) for Extremely Space-Constrained Applications
- -1.5 V Gate Drive
- These Devices are Pb-Free, Halogen Free/BFR Free and are RoHS Compliant

#### Applications

- Small Signal Load Switch
- High Speed Interfacing
- Level Shift

#### MAXIMUM RATINGS (T<sub>J</sub> = 25°C unless otherwise stated)

Parameter		Symbol	Value	Unit	
Drain-to-Source Voltage		V <sub>DSS</sub>	20	V	
Gate-to-Source Voltage		V <sub>GS</sub>	±8	V	
Continuous Drain Current (Note 1)	Steady State	T <sub>A</sub> = 25°C	I <sub>D</sub>	-127	mA
			T <sub>A</sub> = 85°C	-91	
	t ≤ 5 s	T <sub>A</sub> = 25°C		-146	
Power Dissipation (Note 1)	Steady State	T <sub>A</sub> = 25°C	P <sub>D</sub>	125	mW
	t ≤ 5 s			166	
Pulsed Drain Current	t <sub>p</sub> = 10 μs	I <sub>DM</sub>	-488	mA	
Operating Junction and Storage Temperature		T <sub>J</sub> , T <sub>STG</sub>	-55 to 150	°C	
Source Current (Body Diode) (Note 2)		I <sub>S</sub>	200	mA	
Lead Temperature for Soldering Purposes (1/8" from case for 10 s)		T <sub>L</sub>	260	°C	

Stresses exceeding those listed in the Maximum Ratings table may damage the device. If any of these limits are exceeded, device functionality should not be assumed, damage may occur and reliability may be affected.

1. Surface-mounted on FR4 board using the minimum recommended pad size, or 2 mm<sup>2</sup>, 1 oz Cu.
2. Pulse Test: pulse width ≤ 300 μs, duty cycle ≤ 2%

This document contains information on a product under development. ON Semiconductor reserves the right to change or discontinue this product without notice.



ON Semiconductor®

[www.onsemi.com](http://www.onsemi.com)

V <sub>(BR)DSS</sub>	R <sub>DS(on)</sub> MAX	I <sub>D</sub> Max
-20 V	5.0 Ω @ -4.5 V	-127 mA
	5.5 Ω @ -3.3 V	
	6.0 Ω @ -2.5 V	
	7.0 Ω @ -1.8 V	
	10 Ω @ -1.5 V	

#### P-CHANNEL MOSFET

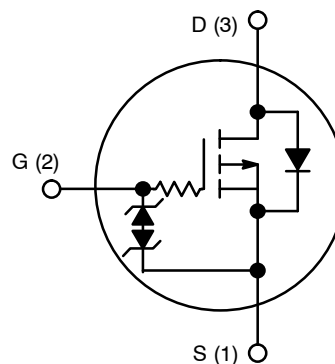

#### MARKING DIAGRAM



XDFN3  
CASE 711BH

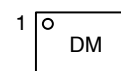

- D = Specific Device Code  
M = Date Code

#### ORDERING INFORMATION

Device	Package	Shipping†
NTNS31350PZTCG	XDFN3 (Pb-Free)	8000 / Tape & Reel

†For information on tape and reel specifications, including part orientation and tape sizes, please refer to our Tape and Reel Packaging Specification Brochure, BRD8011/D.

# NTNS31350PZ

## THERMAL RESISTANCE RATINGS

Parameter	Symbol	Max	Unit
Junction-to-Ambient – Steady State (Note 3)	$R_{\theta JA}$	998	°C/W
Junction-to-Ambient – $t \leq 5$ s (Note 3)	$R_{\theta JA}$	751	

3. Surface-mounted on FR4 board using the minimum recommended pad size, or 2 mm<sup>2</sup>, 1 oz Cu.

## ELECTRICAL CHARACTERISTICS ( $T_J = 25^\circ\text{C}$ unless otherwise stated)

Parameter	Symbol	Test Condition	Min	Typ	Max	Unit
-----------	--------	----------------	-----	-----	-----	------

### OFF CHARACTERISTICS

Drain-to-Source Breakdown Voltage	$V_{(BR)DSS}$	$V_{GS} = 0\text{ V}, I_D = -250\ \mu\text{A}$	-20			V
Zero Gate Voltage Drain Current	$I_{DSS}$	$V_{GS} = 0\text{ V}, V_{DS} = -5\text{ V}$			-50	nA
Zero Gate Voltage Drain Current	$I_{DSS}$	$V_{GS} = 0\text{ V}, V_{DS} = -16\text{ V}$			-100	nA
Gate-to-Source Leakage Current	$I_{GSS}$	$V_{DS} = 0\text{ V}, V_{GS} = \pm 5\text{ V}$			$\pm 100$	nA

### ON CHARACTERISTICS (Note 4)

Gate Threshold Voltage	$V_{GS(TH)}$	$V_{GS} = V_{DS}, I_D = -250\ \mu\text{A}$	-0.4		-1.0	V
Drain-to-Source On Resistance	$R_{DS(on)}$	$V_{GS} = -4.5\text{ V}, I_D = -100\text{ mA}$		2.1	5.0	$\Omega$
		$V_{GS} = -3.3\text{ V}, I_D = -100\text{ mA}$		2.4	5.5	
		$V_{GS} = -2.5\text{ V}, I_D = -50\text{ mA}$		2.7	6.0	
		$V_{GS} = -1.8\text{ V}, I_D = -20\text{ mA}$		3.6	7.0	
		$V_{GS} = -1.5\text{ V}, I_D = -10\text{ mA}$		4.2	10	
Forward Transconductance	$g_{FS}$	$V_{DS} = -5\text{ V}, I_D = -125\text{ mA}$		0.35		S
Source-Drain Diode Voltage	$V_{SD}$	$V_{GS} = 0\text{ V}, I_S = -10\text{ mA}$		-0.6	-1.0	V

### CHARGES & CAPACITANCES

Input Capacitance	$C_{ISS}$	$V_{GS} = 0\text{ V}, \text{freq} = 1\text{ MHz}, V_{DS} = -15\text{ V}$		12.8		pF
Output Capacitance	$C_{OSS}$			2.8		
Reverse Transfer Capacitance	$C_{RSS}$			2.0		

### SWITCHING CHARACTERISTICS, $V_{GS} = 4.5\text{ V}$ (Note 4)

Turn-On Delay Time	$t_{d(ON)}$	$V_{GS} = -4.5\text{ V}, V_{DD} = -15\text{ V}, I_D = 200\text{ mA}, R_G = 2\ \Omega$		37		ns
Rise Time	$t_r$			71		
Turn-Off Delay Time	$t_{d(OFF)}$			280		
Fall Time	$t_f$			171		

4. Switching characteristics are independent of operating junction temperatures.

# NTNS31350PZ

## TYPICAL CHARACTERISTICS

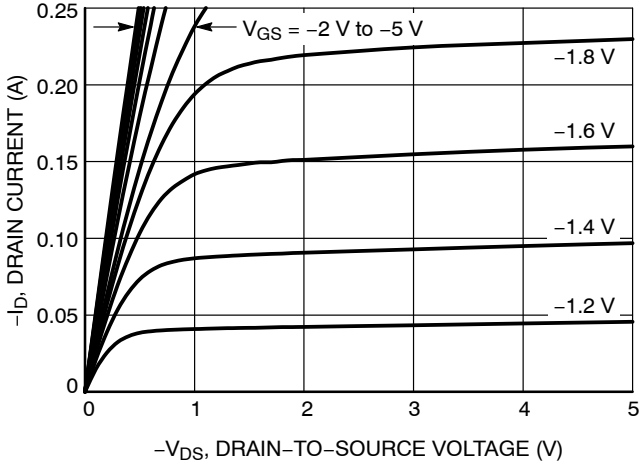

Figure 1. On-Region Characteristics

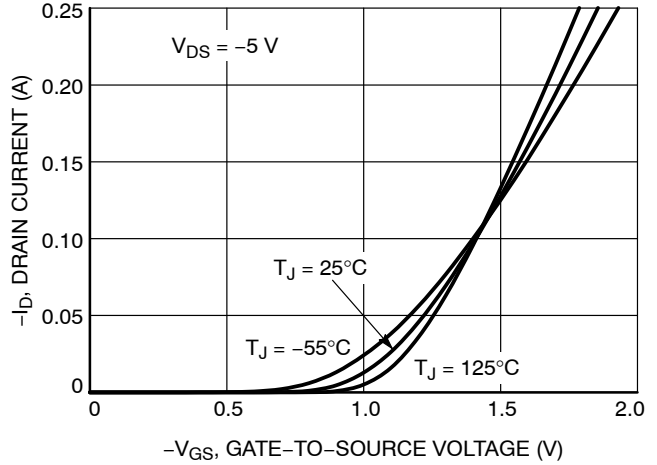

Figure 2. Transfer Characteristics

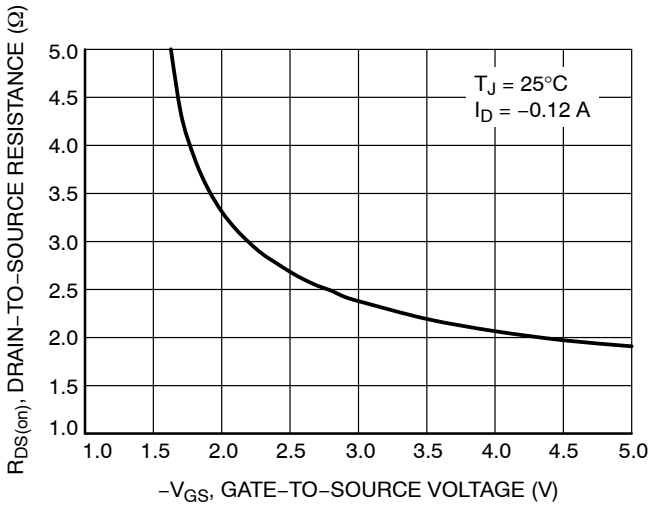

Figure 3. On-Resistance vs. Gate-to-Source Voltage

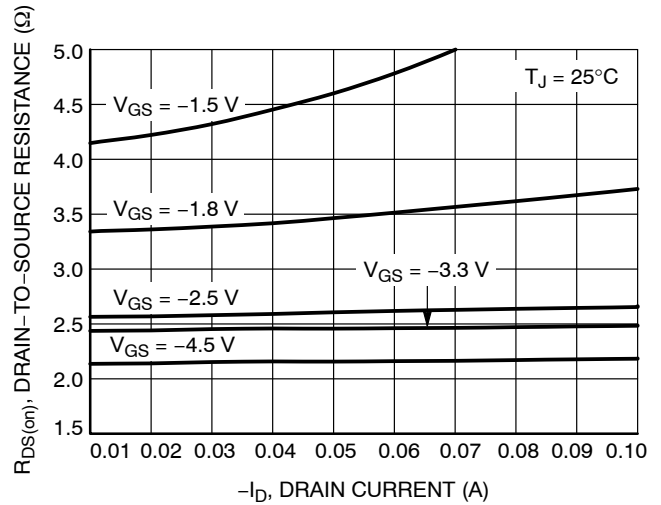

Figure 4. On-Resistance vs. Drain Current and Gate Voltage

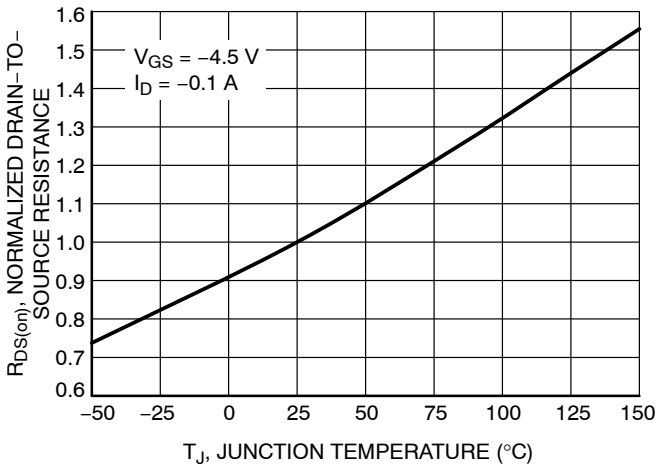

Figure 5. On-Resistance Variation with Temperature

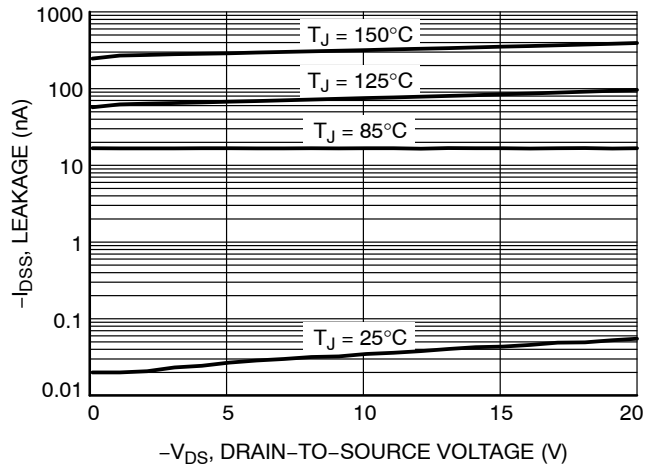

Figure 6. Drain-to-Source Leakage Current vs. Voltage

# NTNS31350PZ

## TYPICAL CHARACTERISTICS

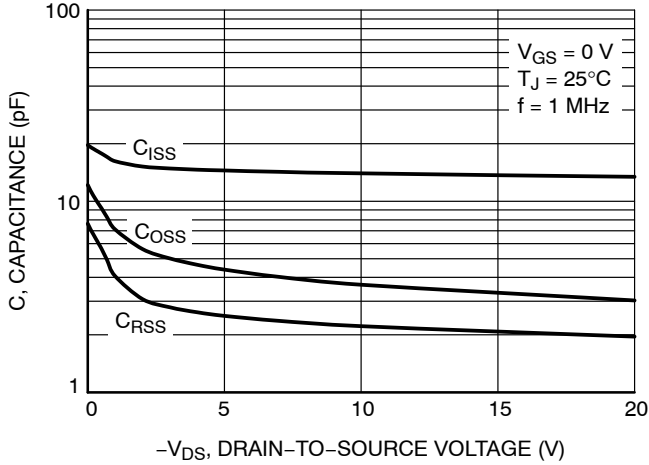

Figure 7. Capacitance Variation

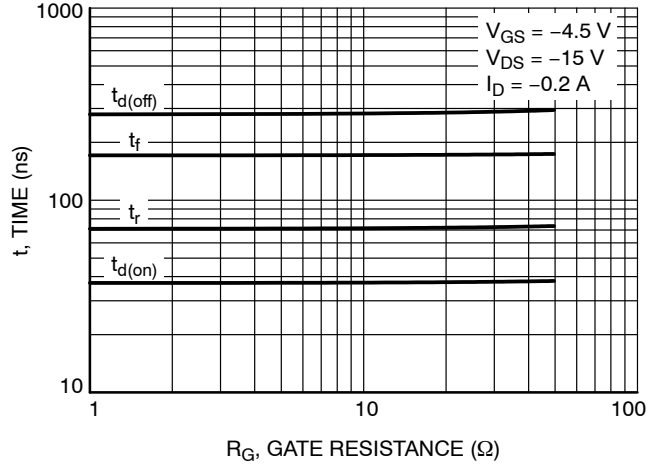

Figure 8. Resistive Switching Time Variation vs. Gate Resistance

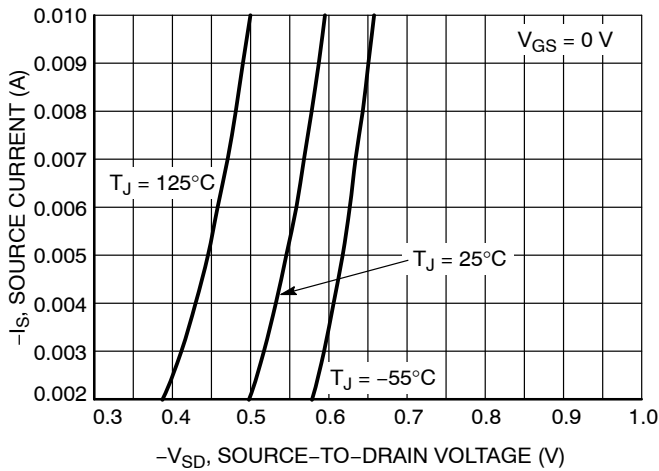

Figure 9. Diode Forward Voltage vs. Current

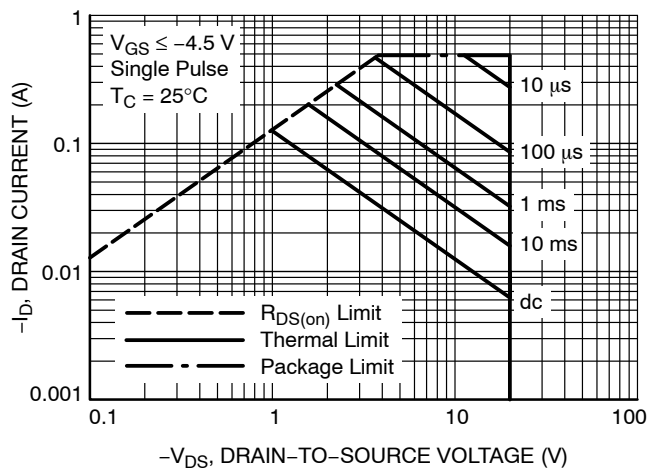

Figure 10. Maximum Rated Forward Biased Safe Operating Area

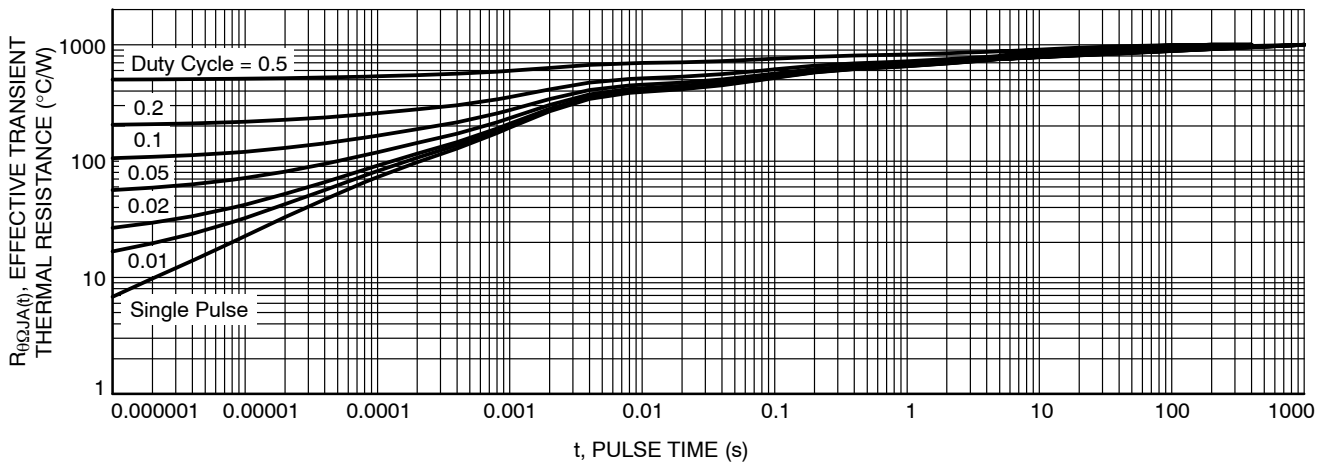
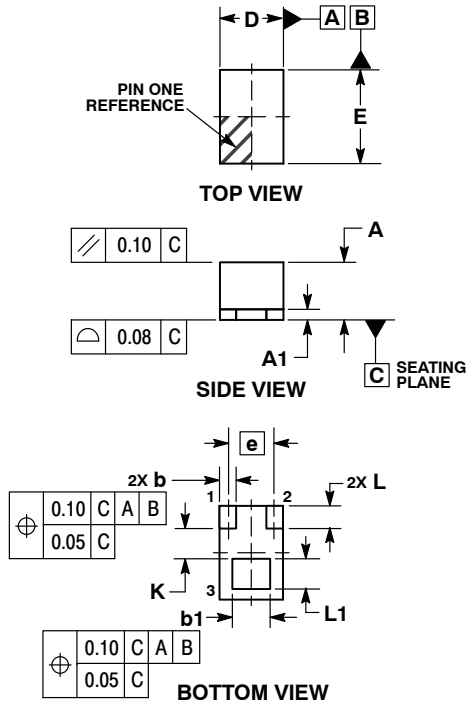

Figure 11. Thermal Response

# NTNS31350PZ

## PACKAGE DIMENSIONS

**XDFN3 0.42x0.62, 0.3P**  
**CASE 711BH**  
**ISSUE O**



- NOTES:
1. DIMENSIONING AND TOLERANCING PER ASME Y14.5M, 1994.
  2. CONTROLLING DIMENSION: MILLIMETERS.
  3. DIMENSION b AND b1 APPLIES TO THE PLATED TERMINALS AND IS MEASURED BETWEEN 0.20 AND 0.25MM FROM THE TERMINAL TIP.
  4. COPLANARITY APPLIES TO THE PLATED TERMINALS.

MILLIMETERS			
DIM	MIN	NOM	MAX
A	0.33	0.38	0.43
A1	---	---	0.07
b	0.05	0.11	0.17
b1	0.20	0.25	0.30
D	0.32	0.42	0.52
E	0.52	0.62	0.72
e	0.30 BSC		
L	0.09	0.15	0.21
L1	0.15	0.20	0.25
K	0.20 REF		

### RECOMMENDED SOLDER FOOTPRINT\*

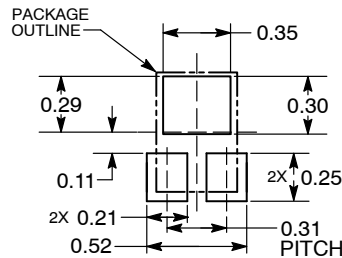

DIMENSIONS: MILLIMETERS

\*For additional information on our Pb-Free strategy and soldering details, please download the ON Semiconductor Soldering and Mounting Techniques Reference Manual, SOLDERRM/D.

ON Semiconductor and are trademarks of Semiconductor Components Industries, LLC dba ON Semiconductor or its subsidiaries in the United States and/or other countries. ON Semiconductor owns the rights to a number of patents, trademarks, copyrights, trade secrets, and other intellectual property. A listing of ON Semiconductor's product/patent coverage may be accessed at [www.onsemi.com/site/pdf/Patent-Marking.pdf](http://www.onsemi.com/site/pdf/Patent-Marking.pdf). ON Semiconductor reserves the right to make changes without further notice to any products herein. ON Semiconductor makes no warranty, representation or guarantee regarding the suitability of its products for any particular purpose, nor does ON Semiconductor assume any liability arising out of the application or use of any product or circuit, and specifically disclaims any and all liability, including without limitation special, consequential or incidental damages. Buyer is responsible for its products and applications using ON Semiconductor products, including compliance with all laws, regulations and safety requirements or standards, regardless of any support or applications information provided by ON Semiconductor. "Typical" parameters which may be provided in ON Semiconductor data sheets and/or specifications can and do vary in different applications and actual performance may vary over time. All operating parameters, including "Typicals" must be validated for each customer application by customer's technical experts. ON Semiconductor does not convey any license under its patent rights nor the rights of others. ON Semiconductor products are not designed, intended, or authorized for use as a critical component in life support systems or any FDA Class 3 medical devices or medical devices with a same or similar classification in a foreign jurisdiction or any devices intended for implantation in the human body. Should Buyer purchase or use ON Semiconductor products for any such unintended or unauthorized application, Buyer shall indemnify and hold ON Semiconductor and its officers, employees, subsidiaries, affiliates, and distributors harmless against all claims, costs, damages, and expenses, and reasonable attorney fees arising out of, directly or indirectly, any claim of personal injury or death associated with such unintended or unauthorized use, even if such claim alleges that ON Semiconductor was negligent regarding the design or manufacture of the part. ON Semiconductor is an Equal Opportunity/Affirmative Action Employer. This literature is subject to all applicable copyright laws and is not for resale in any manner.

### PUBLICATION ORDERING INFORMATION

#### LITERATURE FULFILLMENT:

Literature Distribution Center for ON Semiconductor  
 19521 E. 32nd Pkwy, Aurora, Colorado 80011 USA  
**Phone:** 303-675-2175 or 800-344-3860 Toll Free USA/Canada  
**Fax:** 303-675-2176 or 800-344-3867 Toll Free USA/Canada  
**Email:** [orderlit@onsemi.com](mailto:orderlit@onsemi.com)

**N. American Technical Support:** 800-282-9855 Toll Free  
 USA/Canada  
**Europe, Middle East and Africa Technical Support:**  
 Phone: 421 33 790 2910

**ON Semiconductor Website:** [www.onsemi.com](http://www.onsemi.com)  
**Order Literature:** <http://www.onsemi.com/orderlit>

For additional information, please contact your local Sales Representative