

NTR1P02LS

Power MOSFET

-20 V, -1.3 A, P-Channel SOT-23 Package

These miniature surface mount MOSFETs low $R_{DS(on)}$ assure minimal power loss and conserve energy, making these devices ideal for use in space sensitive power management circuitry. Typical applications are DC-DC converters and power management in portable and battery-powered products such as computers, printers, PCMCIA cards, cellular and cordless telephones.

Features

- Low $R_{DS(on)}$ Provides Higher Efficiency and Extends Battery Life
- Miniature SOT-23 Surface Mount Package Saves Board Space
- These Devices are Pb-Free and are RoHS Compliant

MAXIMUM RATINGS ($T_J = 25^\circ\text{C}$ unless otherwise noted)

Rating	Symbol	Value	Unit
Drain-to-Source Voltage	V_{DS}	-20	V
Gate-to-Source Voltage - Continuous	V_{GS}	± 12	V
Drain Current - Continuous @ $T_A = 25^\circ\text{C}$ - Pulsed Drain Current ($t_p \leq 10 \mu\text{s}$)	I_D I_{DM}	-1.3 -4.0	A A
Total Power Dissipation @ $T_A = 25^\circ\text{C}$	P_D	400	mW
Operating and Storage Temperature Range	T_J, T_{stg}	-55 to 150	$^\circ\text{C}$
Continuous Source Current (Body Diode)	I_S	-0.6	A
Pulse Source Current (Body Diode) (Note 1)	I_{SM}	-0.75	A
Thermal Resistance - Junction-to-Ambient	$R_{\theta JA}$	300	$^\circ\text{C}/\text{W}$
Maximum Lead Temperature for Soldering Purposes, (1/8" from case for 10 s)	T_L	260	$^\circ\text{C}$

Stresses exceeding those listed in the Maximum Ratings table may damage the device. If any of these limits are exceeded, device functionality should not be assumed, damage may occur and reliability may be affected.

1. Guaranteed by design.



ON Semiconductor®

www.onsemi.com

$V_{(BR)DSS}$	$R_{DS(on)}$ Max	I_D Max
-20 V	220 m Ω @ -4.5 V	-1.3 A

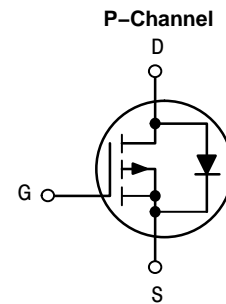

MARKING DIAGRAM & PIN ASSIGNMENT

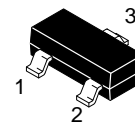

SOT-23
CASE 318
STYLE 21

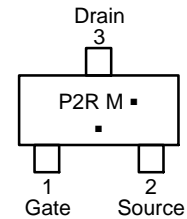

P2R = Specific Device Code
M = Date Code*
▪ = Pb-Free Package

(Note: Microdot may be in either location)
*Date Code orientation may vary depending upon manufacturing location.

ORDERING INFORMATION

Device	Package	Shipping†
NTR1P02LST1G	SOT-23 (Pb-Free)	3000 Tape & Reel

†For information on tape and reel specifications, including part orientation and tape sizes, please refer to our Tape and Reel Packaging Specifications Brochure, BRD8011/D.

NTR1P02LS

THERMAL RESISTANCE MAXIMUM RATINGS

Parameter	Symbol	Typ	Max	Unit
Junction-to-Ambient (Note 2)	$R_{\theta JA}$	282	300	$^{\circ}\text{C/W}$

2. Surface-mounted on FR4 board using the minimum recommended pad size.

ELECTRICAL CHARACTERISTICS ($T_A = 25^{\circ}\text{C}$ unless otherwise noted)

Parameter	Test Condition	Symbol	Min	Typ	Max	Unit
OFF CHARACTERISTICS						
Drain-to-Source Breakdown Voltage	$(V_{GS} = 0\text{ V}, I_D = -10\ \mu\text{A})$	$V_{(BR)DSS}$	-20			V
Zero Gate Voltage Drain Current	$(V_{DS} = -16\text{ V}, V_{GS} = 0\text{ V})$ $(V_{DS} = -16\text{ V}, V_{GS} = 0\text{ V}, T_J = 125^{\circ}\text{C})$	I_{DSS}			-1.0 -10	μA
Gate-Body Leakage Current	$(V_{GS} = \pm 12\text{ V}, V_{DS} = 0\text{ V})$	I_{GSS}			± 100	nA

ON CHARACTERISTICS (Note 1)

Gate Threshold Voltage	$(V_{DS} = V_{GS}, I_D = -250\ \mu\text{A})$	$V_{GS(th)}$	-0.7	-1.0	-1.25	V
Static Drain-to-Source On-Resistance	$(V_{GS} = -4.5\text{ V}, I_D = -0.75\text{ A})$ $(V_{GS} = -2.5\text{ V}, I_D = -0.5\text{ A})$	$r_{DS(on)}$		0.14 0.20	0.22 0.35	Ω

DYNAMIC CHARACTERISTICS

Input Capacitance	$(V_{DS} = -5.0\text{ V})$	C_{iss}	158	225	293	pF
Output Capacitance	$(V_{DS} = -5.0\text{ V})$	C_{oss}	91	130	169	
Transfer Capacitance	$(V_{DS} = -5.0\text{ V})$	C_{rss}		55	72	
Total Gate Charge	$(V_{DS} = -16\text{ V}, I_D = -1.5\text{ A}, V_{GS} = -4.5\text{ V})$	Q_T	3.9	5.5	7.2	nC

SWITCHING CHARACTERISTICS (Note 2)

Turn-On Delay Time	$(V_{GS} = -4.5\text{ V}, V_{DD} = -5.0\text{ V}, I_D = -1.0\text{ A}, R_L = 5.0\ \Omega, R_G = 6.0\ \Omega)$	$t_{d(on)}$		7.0	9.0	ns
Rise Time		t_r		15	20	
Turn-Off Delay Time		$t_{d(off)}$		18	23	
Fall Time		t_f		9	26	

SOURCE-DRAIN DIODE CHARACTERISTICS

Continuous Current		I_S			-0.6	A
Pulsed Current		I_{SM}			-0.75	
Forward Voltage (Note 2)	$(V_{GS} = 0\text{ V}, I_S = -0.6\text{ A})$	V_{SD}		-0.7	-1.0	V
Reverse Recovery Time	$(I_S = -1.0\text{ A}, V_{GS} = 0\text{ V}, di_S/dt = 100\text{ A}/\mu\text{s})$	t_{rr}		16	21	ns
		t_a		11		
		t_b		5.5		
Reverse Recovery Stored Charge		Q_{RR}		8.5		nC
Gate Resistance		R_G		9.0	12	Ω

Product parametric performance is indicated in the Electrical Characteristics for the listed test conditions, unless otherwise noted. Product performance may not be indicated by the Electrical Characteristics if operated under different conditions.

1. Pulse Test: Pulse Width $\leq 300\ \mu\text{s}$, Duty Cycle $\leq 2\%$.
2. Switching characteristics are independent of operating junction temperature.

NTR1P02LS

TYPICAL CHARACTERISTICS

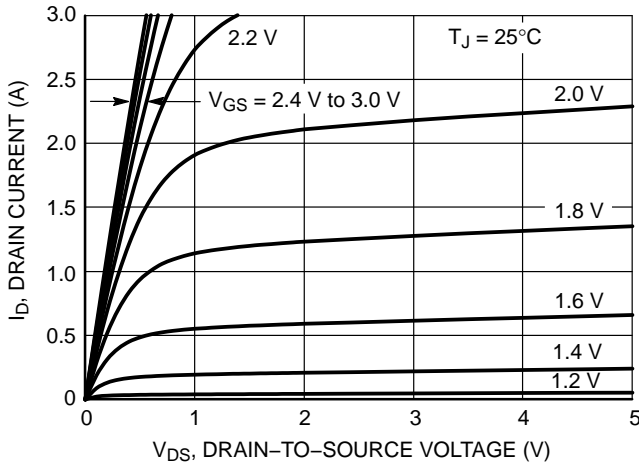

Figure 1. On-Region Characteristics

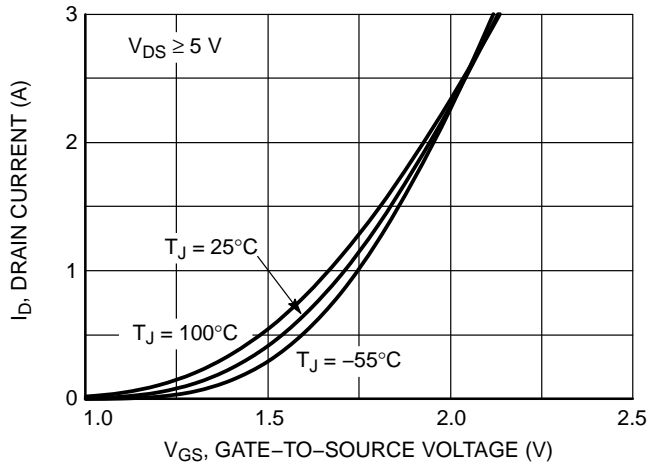

Figure 2. Transfer Characteristics

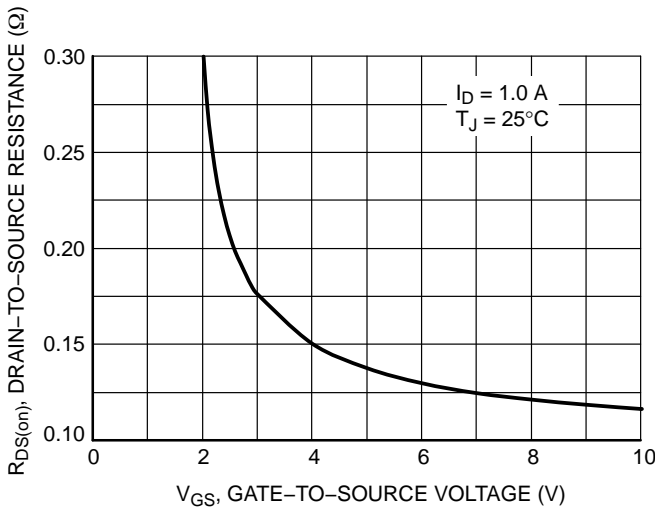

Figure 3. On-Resistance vs. Gate-to-Source Voltage

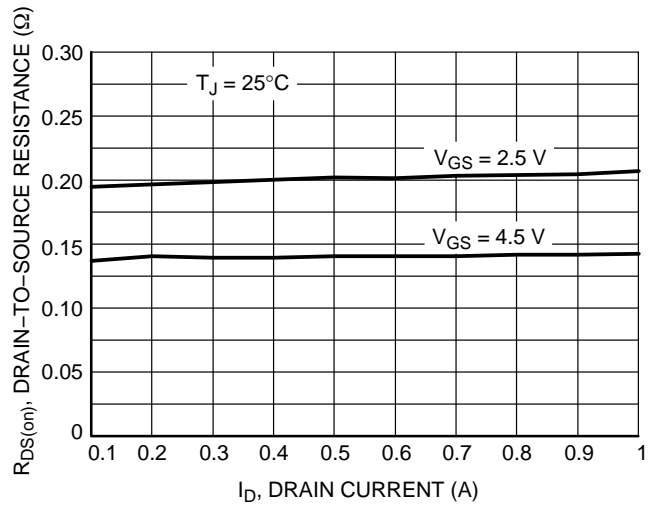

Figure 4. On-Resistance vs. Drain Current and Gate Voltage

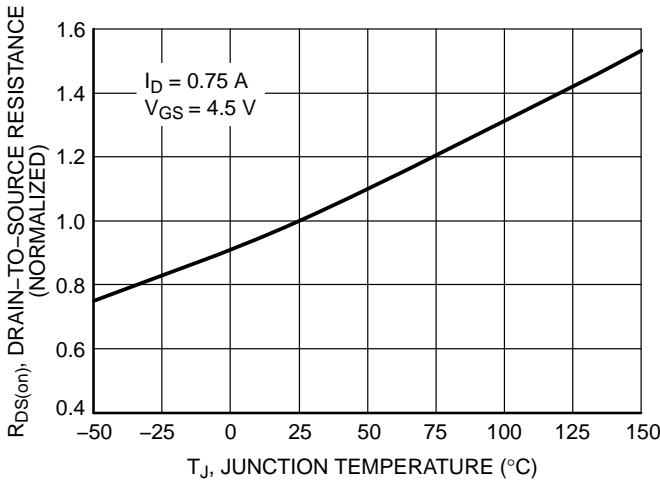

Figure 5. On-Resistance Variation with Temperature

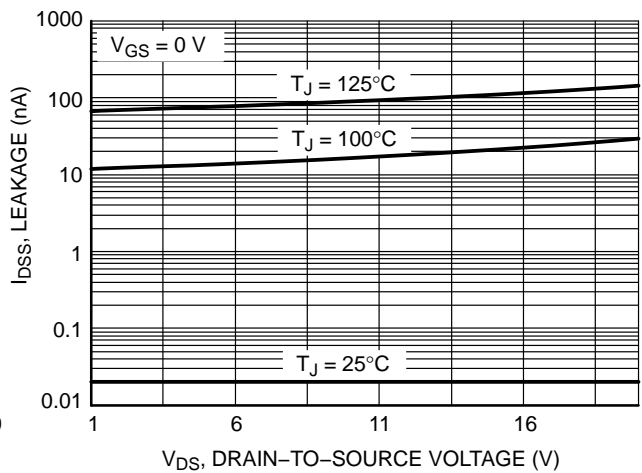

Figure 6. Drain-to-Source Leakage Current vs. Voltage

NTR1P02LS

TYPICAL CHARACTERISTICS

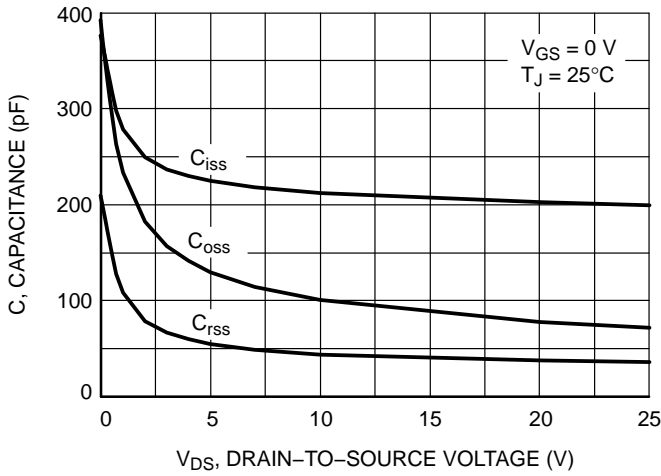

Figure 7. Capacitance Variation

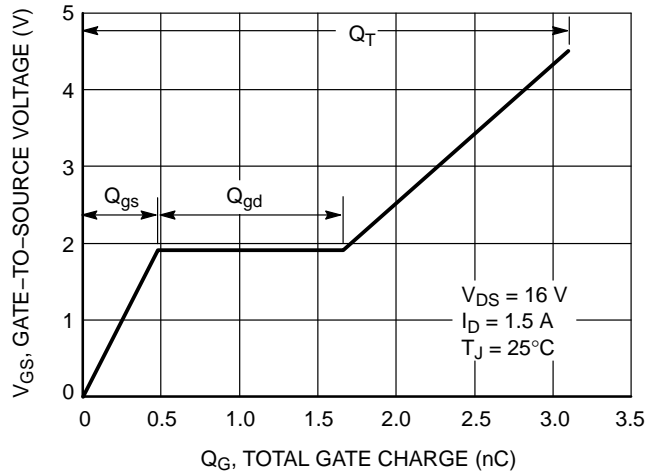

Figure 8. Gate-to-Source and Drain-to-Source Voltage vs. Total Charge

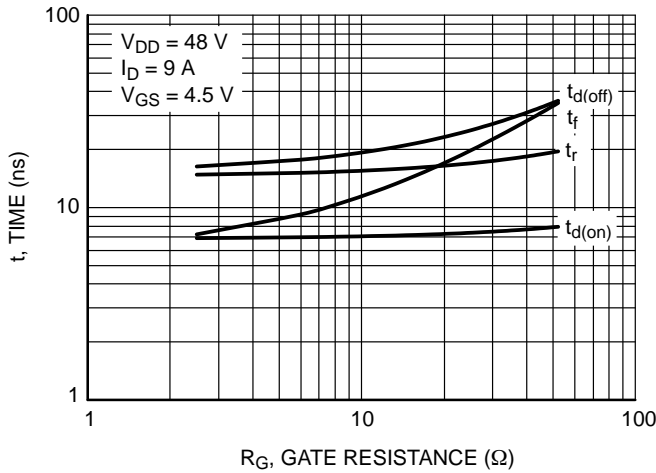

Figure 9. Resistive Switching Time Variation vs. Gate Resistance

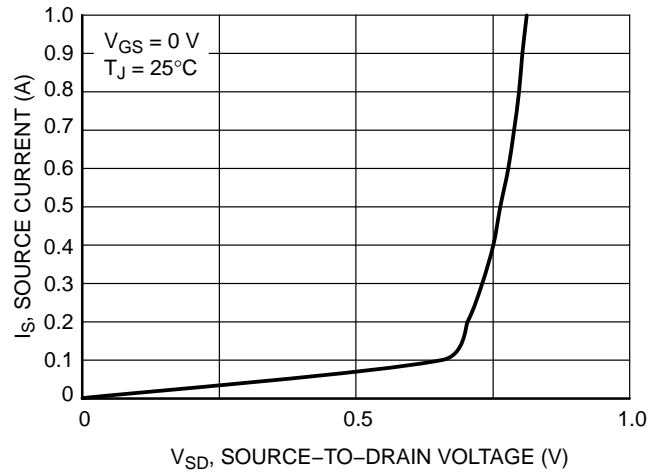

Figure 10. Diode Forward Voltage vs. Current

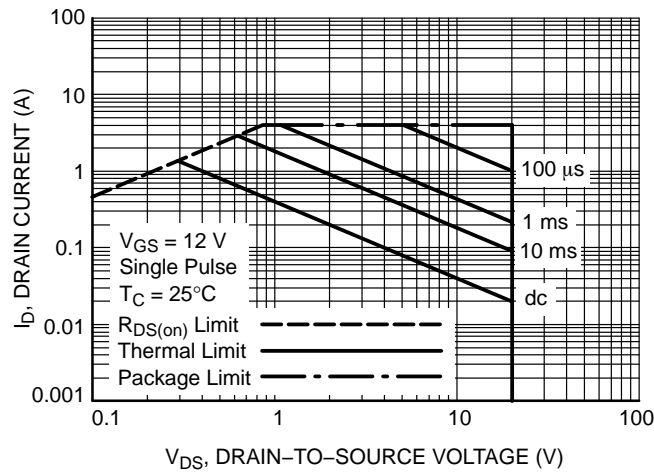
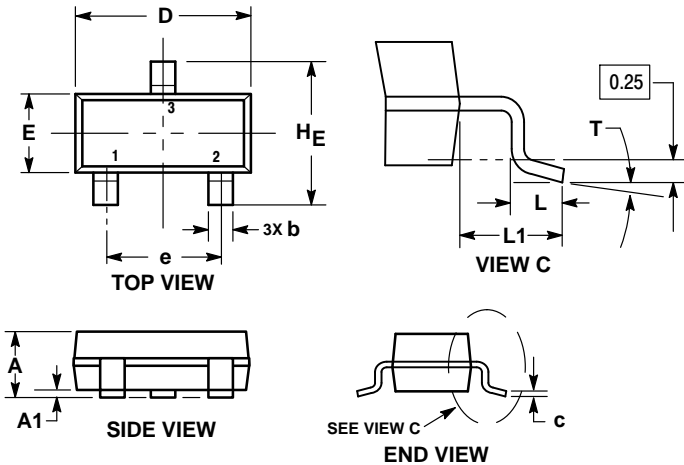

Figure 11. Maximum Rated Forward Biased Safe Operating Area

NTR1P02LS

PACKAGE DIMENSIONS

SOT-23 (TO-236)
CASE 318-08
ISSUE AR



NOTES:

1. DIMENSIONING AND TOLERANCING PER ASME Y14.5M, 1994.
2. CONTROLLING DIMENSION: MILLIMETERS.
3. MAXIMUM LEAD THICKNESS INCLUDES LEAD FINISH. MINIMUM LEAD THICKNESS IS THE MINIMUM THICKNESS OF THE BASE MATERIAL.
4. DIMENSIONS D AND E DO NOT INCLUDE MOLD FLASH, PROTRUSIONS, OR GATE BURRS.

DIM	MILLIMETERS			INCHES		
	MIN	NOM	MAX	MIN	NOM	MAX
A	0.89	1.00	1.11	0.035	0.039	0.044
A1	0.01	0.06	0.10	0.000	0.002	0.004
b	0.37	0.44	0.50	0.015	0.017	0.020
c	0.08	0.14	0.20	0.003	0.006	0.008
D	2.80	2.90	3.04	0.110	0.114	0.120
E	1.20	1.30	1.40	0.047	0.051	0.055
e	1.78	1.90	2.04	0.070	0.075	0.080
L	0.30	0.43	0.55	0.012	0.017	0.022
L1	0.35	0.54	0.69	0.014	0.021	0.027
HE	2.10	2.40	2.64	0.083	0.094	0.104
T	0°	---	10°	0°	---	10°

STYLE 21:

1. GATE
2. SOURCE
3. DRAIN

RECOMMENDED SOLDERING FOOTPRINT*

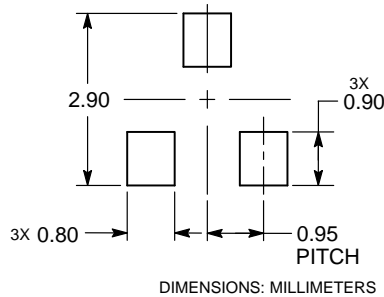

DIMENSIONS: MILLIMETERS

*For additional information on our Pb-Free strategy and soldering details, please download the ON Semiconductor Soldering and Mounting Techniques Reference Manual, SOLDERRM/D.

ON Semiconductor and are trademarks of Semiconductor Components Industries, LLC dba ON Semiconductor or its subsidiaries in the United States and/or other countries. ON Semiconductor owns the rights to a number of patents, trademarks, copyrights, trade secrets, and other intellectual property. A listing of ON Semiconductor's product/patent coverage may be accessed at www.onsemi.com/site/pdf/Patent-Marking.pdf. ON Semiconductor reserves the right to make changes without further notice to any products herein. ON Semiconductor makes no warranty, representation or guarantee regarding the suitability of its products for any particular purpose, nor does ON Semiconductor assume any liability arising out of the application or use of any product or circuit, and specifically disclaims any and all liability, including without limitation special, consequential or incidental damages. Buyer is responsible for its products and applications using ON Semiconductor products, including compliance with all laws, regulations and safety requirements or standards, regardless of any support or applications information provided by ON Semiconductor. "Typical" parameters which may be provided in ON Semiconductor data sheets and/or specifications can and do vary in different applications and actual performance may vary over time. All operating parameters, including "Typicals" must be validated for each customer application by customer's technical experts. ON Semiconductor does not convey any license under its patent rights nor the rights of others. ON Semiconductor products are not designed, intended, or authorized for use as a critical component in life support systems or any FDA Class 3 medical devices or medical devices with a same or similar classification in a foreign jurisdiction or any devices intended for implantation in the human body. Should Buyer purchase or use ON Semiconductor products for any such unintended or unauthorized application, Buyer shall indemnify and hold ON Semiconductor and its officers, employees, subsidiaries, affiliates, and distributors harmless against all claims, costs, damages, and expenses, and reasonable attorney fees arising out of, directly or indirectly, any claim of personal injury or death associated with such unintended or unauthorized use, even if such claim alleges that ON Semiconductor was negligent regarding the design or manufacture of the part. ON Semiconductor is an Equal Opportunity/Affirmative Action Employer. This literature is subject to all applicable copyright laws and is not for resale in any manner.

PUBLICATION ORDERING INFORMATION

LITERATURE FULFILLMENT:
Literature Distribution Center for ON Semiconductor
19521 E. 32nd Pkwy, Aurora, Colorado 80011 USA
Phone: 303-675-2175 or 800-344-3860 Toll Free USA/Canada
Fax: 303-675-2176 or 800-344-3867 Toll Free USA/Canada
Email: orderlit@onsemi.com

N. American Technical Support: 800-282-9855 Toll Free USA/Canada
Europe, Middle East and Africa Technical Support:
Phone: 421 33 790 2910
Japan Customer Focus Center
Phone: 81-3-5817-1050

ON Semiconductor Website: www.onsemi.com
Order Literature: <http://www.onsemi.com/orderlit>

For additional information, please contact your local Sales Representative