

NTR5198NL

MOSFET – Power, Single, N-Channel, Logic Level, SOT-23

60 V, 155 mΩ



ON Semiconductor®

www.onsemi.com

Features

- Small Footprint Industry Standard Surface Mount SOT–23 Package
- Low $R_{DS(on)}$ for Low Conduction Losses and Improved Efficiency
- These Devices are Pb–Free, Halogen Free/BFR Free and are RoHS Compliant

MAXIMUM RATINGS ($T_J = 25^\circ\text{C}$ unless otherwise noted)

Parameter	Symbol	Value	Unit	
Drain-to-Source Voltage	V_{DSS}	60	V	
Gate-to-Source Voltage	V_{GS}	± 20	V	
Continuous Drain Current $R_{\Psi J-mb}$ (Notes 1, 2, 3, and 4)	Steady State	$T_A = 25^\circ\text{C}$	I_D 2.2	A
		$T_A = 100^\circ\text{C}$	1.6	
Power Dissipation $R_{\Psi J-mb}$ (Notes 1 and 3)	Steady State	$T_A = 25^\circ\text{C}$	P_D 1.5	W
		$T_A = 100^\circ\text{C}$	0.6	
Continuous Drain Current $R_{\theta JA}$ (Note 1, 2, 3, and 4)	Steady State	$T_A = 25^\circ\text{C}$	I_D 1.7	A
		$T_A = 100^\circ\text{C}$	1.2	
Power Dissipation $R_{\theta JA}$ (Notes 1 and 3)	Steady State	$T_A = 25^\circ\text{C}$	P_D 0.9	W
		$T_A = 100^\circ\text{C}$	0.4	
Pulsed Drain Current	$T_A = 25^\circ\text{C}$, $t_p = 10 \mu\text{s}$	I_{DM} 27	A	
Operating Junction and Storage Temperature	T_J , T_{stg}	-55 to 150	$^\circ\text{C}$	
Source Current (Body Diode)	I_S	1.9	A	
Lead Temperature for Soldering Purposes (1/8" from case for 10 s)	T_L	260	$^\circ\text{C}$	

Stresses exceeding those listed in the Maximum Ratings table may damage the device. If any of these limits are exceeded, device functionality should not be assumed, damage may occur and reliability may be affected.

1. The entire application environment impacts the thermal resistance values shown, they are not constants and are only valid for the particular conditions noted.
2. Psi (Ψ) is used as required per JESD51–12 for packages in which substantially less than 100% of the heat flows to single case surface.
3. Surface-mounted on FR4 board using a 650 mm², 2 oz. Cu pad.
4. Maximum current for pulses as long as 1 second is higher but is dependent on pulse duration and duty cycle.

$V_{(BR)DSS}$	$R_{DS(on)}$ TYP	I_D MAX
60 V	155 mΩ @ 10 V	2.2 A
	205 mΩ @ 4.5 V	

N-Channel

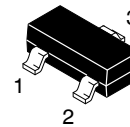
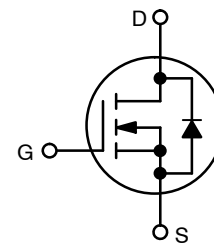

SOT-23
CASE 318
STYLE 21

MARKING DIAGRAM/ PIN ASSIGNMENT

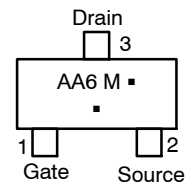

AA6 = Device Code
M = Date Code*
▪ = Pb–Free Package

(Note: Microdot may be in either location)

*Date Code orientation may vary depending upon manufacturing location.

ORDERING INFORMATION

Device	Package	Shipping†
NTR5198NLT1G	SOT–23 (Pb–Free)	3000 / Tape & Reel
NTR5198NLT3G	SOT–23 (Pb–Free)	10000 / Tape & Reel

†For information on tape and reel specifications, including part orientation and tape sizes, please refer to our Tape and Reel Packaging Specification Brochure, BRD8011/D.

NTR5198NL

THERMAL RESISTANCE RATINGS

Parameter	Symbol	Max	Unit
Junction-to-Lead #3 – Drain (Notes 2 and 3)	$R_{\Psi J-mb}$	86	°C/W
Junction-to-Ambient – Steady State (Note 3)	$R_{\theta JA}$	139	°C/W

ELECTRICAL CHARACTERISTICS ($T_J = 25^\circ\text{C}$ unless otherwise noted)

Parameter	Symbol	Test Conditions	Min	Typ	Max	Unit
OFF CHARACTERISTICS						
Drain-to-Source Breakdown Voltage	$V_{(BR)DSS}$	$V_{GS} = 0\text{ V}, I_D = 250\ \mu\text{A}$	60			V
Drain-to-Source Breakdown Voltage Temperature Coefficient	$V_{(BR)DSS}/T_J$	Reference to 25°C , $I_D = 250\ \mu\text{A}$		70		mV/°C
Zero Gate Voltage Drain Current	I_{DSS}	$V_{GS} = 0\text{ V}, V_{DS} = 60\text{ V}$	$T_J = 25^\circ\text{C}$		1.0	μA
			$T_J = 125^\circ\text{C}$		10	
Gate-to-Source Leakage Current	I_{GSS}	$V_{DS} = 0\text{ V}, V_{GS} = \pm 20\text{ V}$			± 100	nA

ON CHARACTERISTICS (Note 5)

Gate Threshold Voltage	$V_{GS(TH)}$	$V_{GS} = V_{DS}, I_D = 250\ \mu\text{A}$	1.5		2.5	V
Threshold Temperature Coefficient	$V_{GS(TH)}/T_J$	Reference to 25°C , $I_D = 250\ \mu\text{A}$		-6.5		mV/°C
Drain-to-Source On-Resistance	$R_{DS(on)}$	$V_{GS} = 10\text{ V}, I_D = 1\text{ A}$		107	155	m Ω
		$V_{GS} = 4.5\text{ V}, I_D = 1\text{ A}$		142	205	
Forward Transconductance	g_{FS}	$V_{DS} = 5.0\text{ V}, I_D = 1\text{ A}$		3		S

CHARGES, CAPACITANCES & GATE RESISTANCE

Input Capacitance	C_{iss}	$V_{GS} = 0\text{ V}, f = 1.0\text{ MHz}, V_{DS} = 25\text{ V}$		182		pF	
Output Capacitance	C_{oss}			25			
Reverse Transfer Capacitance	C_{rss}			16			
Total Gate Charge	$Q_{G(TOT)}$	$V_{DS} = 48\text{ V}, I_D = 1\text{ A}$	$V_{GS} = 4.5\text{ V}$		2.8	nC	
			$V_{GS} = 10\text{ V}$		5.1		
Threshold Gate Charge	$Q_{G(TH)}$	$V_{DS} = 48\text{ V}, I_D = 1\text{ A}, V_{GS} = 10\text{ V}$			0.3		
Gate-to-Source Charge	Q_{GS}				0.8		
Gate-to-Drain Charge	Q_{GD}				1.5		
Plateau Voltage	V_{GP}				3.1		V
Gate Resistance	R_G				8		Ω

SWITCHING CHARACTERISTICS (Note 6)

Turn-On Delay Time	$t_{d(on)}$	$V_{DS} = 30\text{ V}, V_{GS} = 10\text{ V}, I_D = 1\text{ A}, R_G = 10\ \Omega$		5		ns
Rise Time	t_r			7		
Turn-Off Delay Time	$t_{d(off)}$			13		
Fall Time	t_f			2		

DRAIN-SOURCE DIODE CHARACTERISTICS

Forward Diode Voltage	V_{SD}	$V_{GS} = 0\text{ V}, I_S = 1\text{ A}$	$T_J = 25^\circ\text{C}$		0.8	1.2	V
			$T_J = 125^\circ\text{C}$		0.6		
Reverse Recovery Time	t_{rr}	$I_S = 1\text{ A}_{dc}, V_{GS} = 0\text{ V}_{dc}, dI_S/dt = 100\text{ A}/\mu\text{s}$			12		ns
Charge Time	t_a				9		
Discharge Time	t_b				3		
Reverse Recovery Stored Charge	Q_{RR}				6		

Product parametric performance is indicated in the Electrical Characteristics for the listed test conditions, unless otherwise noted. Product performance may not be indicated by the Electrical Characteristics if operated under different conditions.

5. Pulse Test: Pulse Width $\leq 300\ \mu\text{s}$, Duty Cycle $\leq 2\%$.

6. Switching characteristics are independent of operating junction temperatures.

TYPICAL CHARACTERISTICS

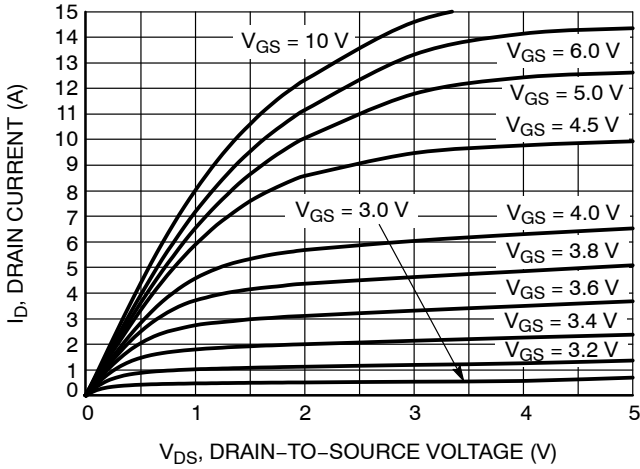

Figure 1. On-Region Characteristics

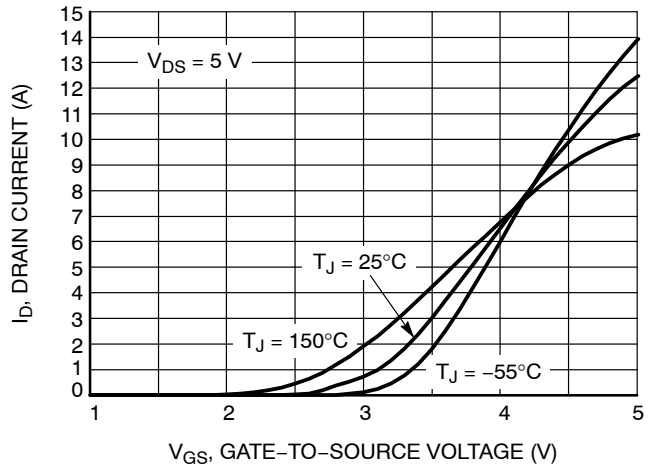

Figure 2. Transfer Characteristics

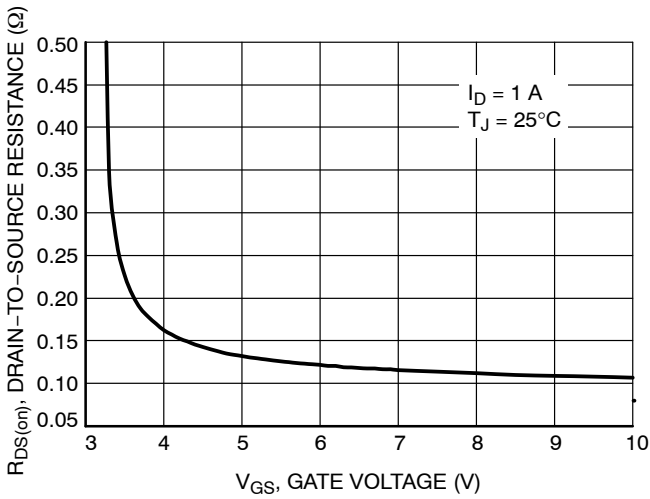

Figure 3. On-Resistance vs. Gate-to-Source Voltage

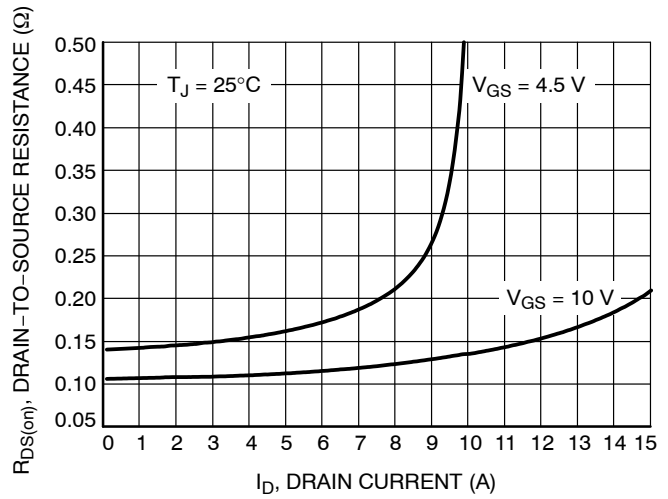

Figure 4. On-Resistance vs. Drain Current and Gate Voltage

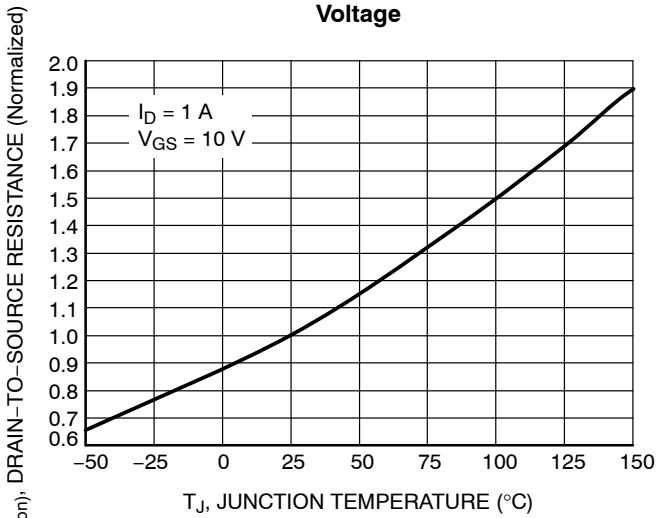

Figure 5. On-Resistance Variation with Temperature

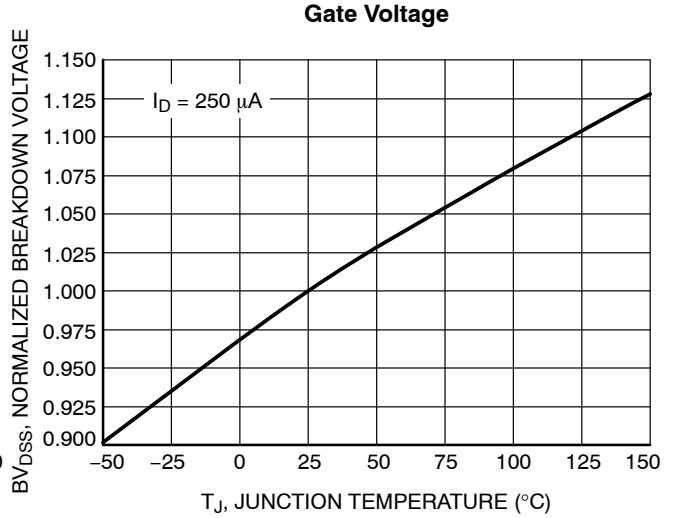

Figure 6. Breakdown Voltage Variation with Temperature

TYPICAL CHARACTERISTICS

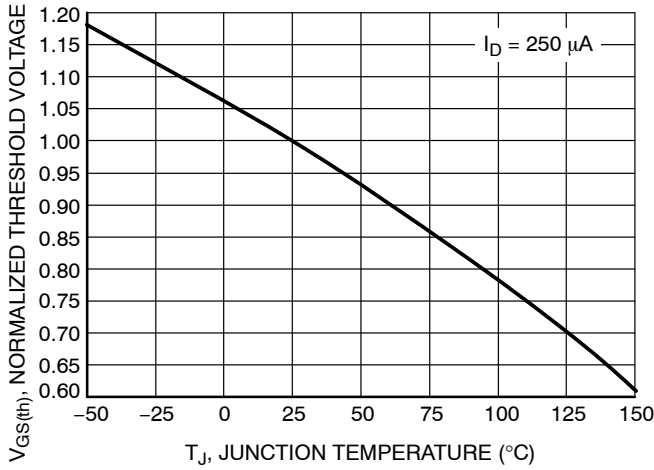

Figure 7. Threshold Voltage Variation with Temperature

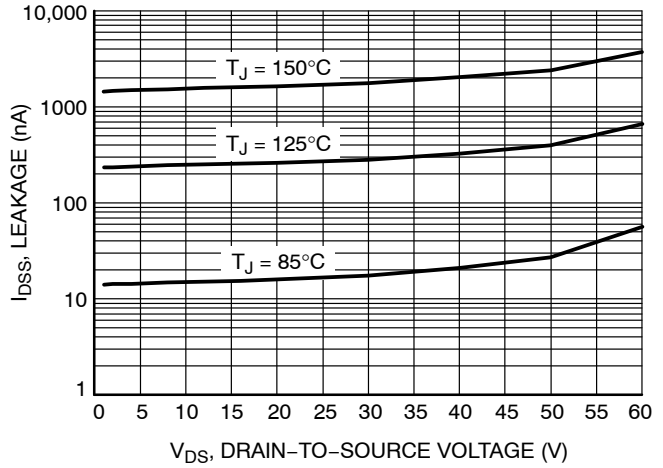

Figure 8. Drain-to-Source Leakage Current vs. Voltage

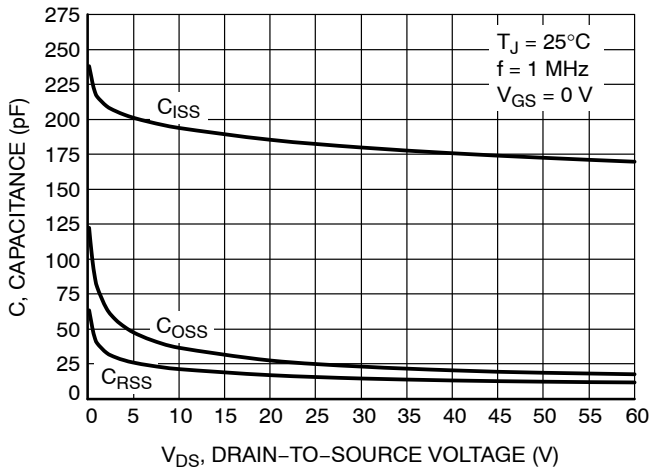

Figure 9. Capacitance Variation

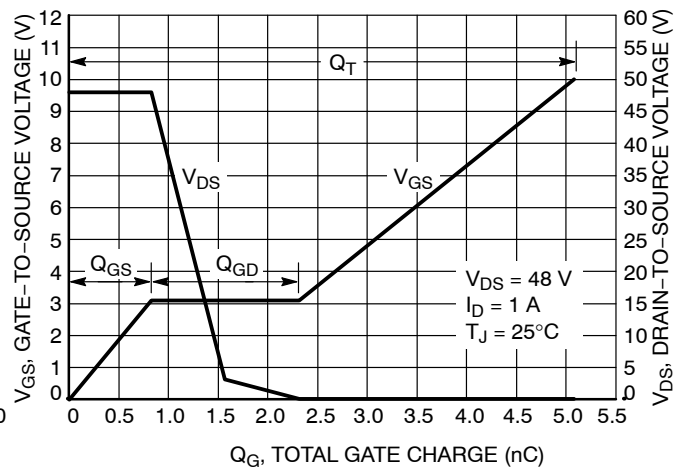

Figure 10. Gate-to-Source and Drain-to-Source Voltage vs. Total Charge

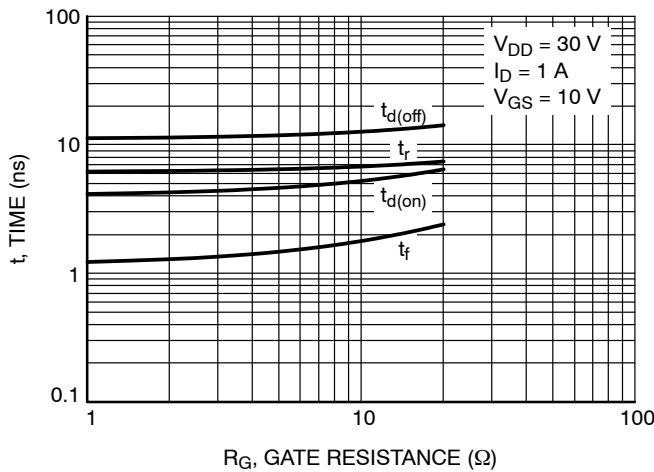

Figure 11. Resistive Switching Time Variation vs. Gate Resistance

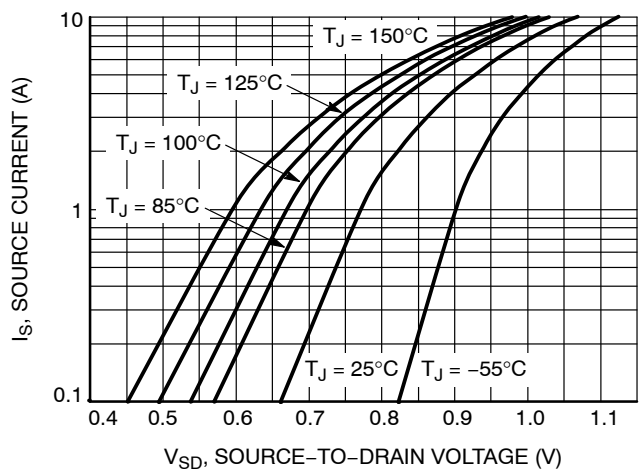

Figure 12. Diode Forward Voltage vs. Current

TYPICAL CHARACTERISTICS

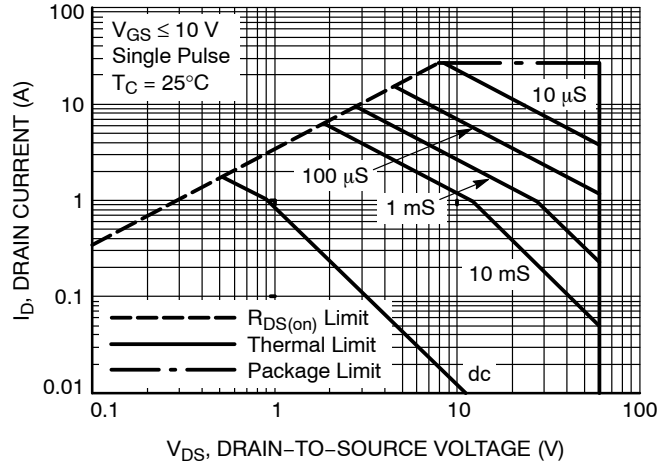

Figure 13. Maximum Rated Forward Biased Safe Operating Area

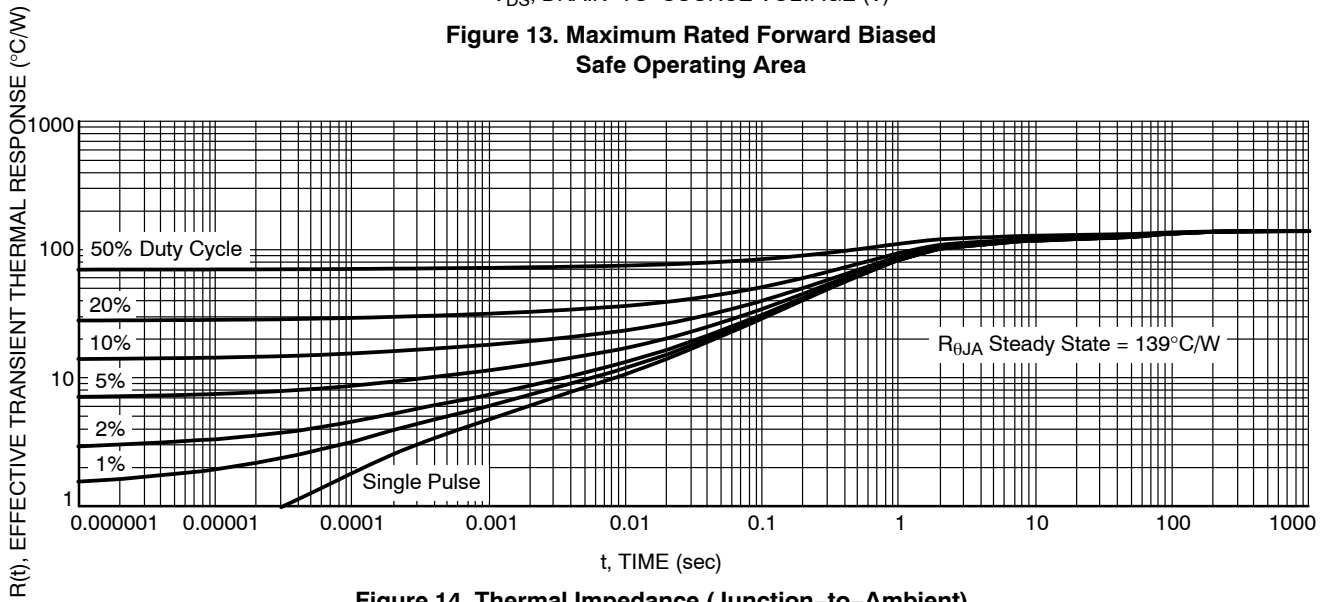
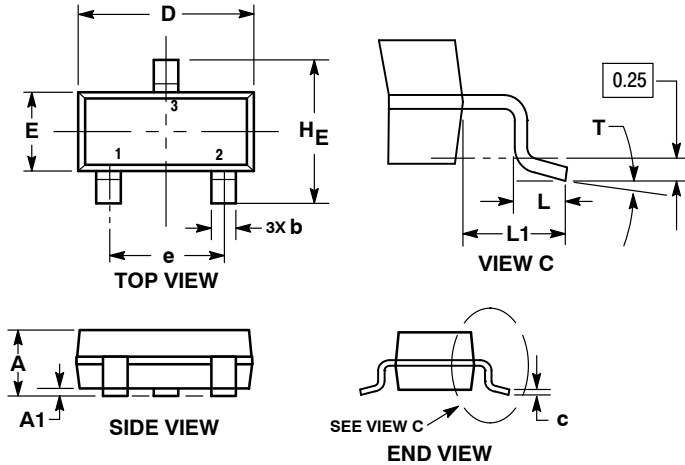

Figure 14. Thermal Impedance (Junction-to-Ambient)

NTR5198NL

PACKAGE DIMENSIONS

SOT-23 (TO-236)
CASE 318-08
ISSUE AR



NOTES:

1. DIMENSIONING AND TOLERANCING PER ASME Y14.5M, 1994.
2. CONTROLLING DIMENSION: MILLIMETERS.
3. MAXIMUM LEAD THICKNESS INCLUDES LEAD FINISH. MINIMUM LEAD THICKNESS IS THE MINIMUM THICKNESS OF THE BASE MATERIAL.
4. DIMENSIONS D AND E DO NOT INCLUDE MOLD FLASH, PROTRUSIONS, OR GATE BURRS.

DIM	MILLIMETERS			INCHES		
	MIN	NOM	MAX	MIN	NOM	MAX
A	0.89	1.00	1.11	0.035	0.039	0.044
A1	0.01	0.06	0.10	0.000	0.002	0.004
b	0.37	0.44	0.50	0.015	0.017	0.020
c	0.08	0.14	0.20	0.003	0.006	0.008
D	2.80	2.90	3.04	0.110	0.114	0.120
E	1.20	1.30	1.40	0.047	0.051	0.055
e	1.78	1.90	2.04	0.070	0.075	0.080
L	0.30	0.43	0.55	0.012	0.017	0.022
L1	0.35	0.54	0.69	0.014	0.021	0.027
HE	2.10	2.40	2.64	0.083	0.094	0.104
T	0°	---	10°	0°	---	10°

STYLE 21:

- PIN 1. GATE
- SOURCE
- DRAIN

RECOMMENDED SOLDERING FOOTPRINT*

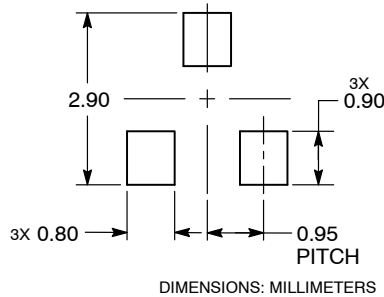

*For additional information on our Pb-Free strategy and soldering details, please download the ON Semiconductor Soldering and Mounting Techniques Reference Manual, SOLDERM/D.

ON Semiconductor and are trademarks of Semiconductor Components Industries, LLC dba ON Semiconductor or its subsidiaries in the United States and/or other countries. ON Semiconductor owns the rights to a number of patents, trademarks, copyrights, trade secrets, and other intellectual property. A listing of ON Semiconductor's product/patent coverage may be accessed at www.onsemi.com/site/pdf/Patent-Marking.pdf. ON Semiconductor reserves the right to make changes without further notice to any products herein. ON Semiconductor makes no warranty, representation or guarantee regarding the suitability of its products for any particular purpose, nor does ON Semiconductor assume any liability arising out of the application or use of any product or circuit, and specifically disclaims any and all liability, including without limitation special, consequential or incidental damages. Buyer is responsible for its products and applications using ON Semiconductor products, including compliance with all laws, regulations and safety requirements or standards, regardless of any support or applications information provided by ON Semiconductor. "Typical" parameters which may be provided in ON Semiconductor data sheets and/or specifications can and do vary in different applications and actual performance may vary over time. All operating parameters, including "Typicals" must be validated for each customer application by customer's technical experts. ON Semiconductor does not convey any license under its patent rights nor the rights of others. ON Semiconductor products are not designed, intended, or authorized for use as a critical component in life support systems or any FDA Class 3 medical devices or medical devices with a same or similar classification in a foreign jurisdiction or any devices intended for implantation in the human body. Should Buyer purchase or use ON Semiconductor products for any such unintended or unauthorized application, Buyer shall indemnify and hold ON Semiconductor and its officers, employees, subsidiaries, affiliates, and distributors harmless against all claims, costs, damages, and expenses, and reasonable attorney fees arising out of, directly or indirectly, any claim of personal injury or death associated with such unintended or unauthorized use, even if such claim alleges that ON Semiconductor was negligent regarding the design or manufacture of the part. ON Semiconductor is an Equal Opportunity/Affirmative Action Employer. This literature is subject to all applicable copyright laws and is not for resale in any manner.

PUBLICATION ORDERING INFORMATION

LITERATURE FULFILLMENT:

Literature Distribution Center for ON Semiconductor
19521 E. 32nd Pkwy, Aurora, Colorado 80011 USA
Phone: 303-675-2175 or 800-344-3860 Toll Free USA/Canada
Fax: 303-675-2176 or 800-344-3867 Toll Free USA/Canada
Email: orderlit@onsemi.com

N. American Technical Support: 800-282-9855 Toll Free
USA/Canada
Europe, Middle East and Africa Technical Support:
Phone: 421 33 790 2910
Japan Customer Focus Center
Phone: 81-3-5817-1050

ON Semiconductor Website: www.onsemi.com

Order Literature: <http://www.onsemi.com/orderlit>

For additional information, please contact your local Sales Representative