

NV24C64

Product Preview

64 Kb I²C CMOS Serial EEPROM

Description

The NV24C64 is a 64 Kb CMOS Serial EEPROM device, internally organized as 8192 words of 8 bits each.

It features a 32-byte page write buffer and supports the Standard (100 kHz), Fast (400 kHz) and Fast-Plus (1 MHz) I²C protocol.

External address pins make it possible to address up to eight NV24C64 devices on the same bus.

Features

- Supports Standard, Fast and Fast-Plus I²C Protocol
- 1.7 V to 5.5 V Supply Voltage Range
- 32-Byte Page Write Buffer
- Hardware Write Protection for Entire Memory
- Schmitt Triggers and Noise Suppression Filters on I²C Bus Inputs (SCL and SDA)
- Low Power CMOS Technology
- 1,000,000 Program/Erase Cycles
- 100 Year Data Retention
- Automotive Grade 2 (105°C) Temperature Range
- SOIC, TSSOP 8-lead and WLCSP 4-bump Packages
- This Device is Pb-Free, Halogen Free/BFR Free, and RoHS Compliant

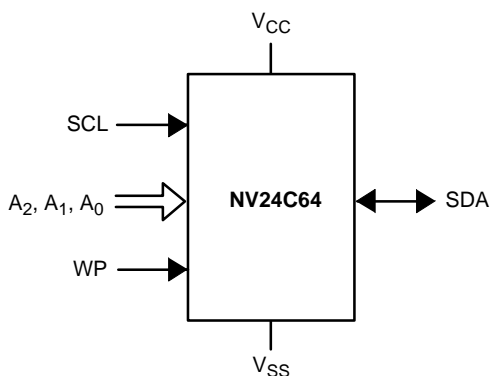

Figure 1. Functional Symbol

This document contains information on a product under development. ON Semiconductor reserves the right to change or discontinue this product without notice.



ON Semiconductor®

www.onsemi.com

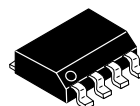

SOIC-8
DW SUFFIX
CASE 751BD

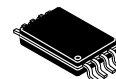

TSSOP-8
DT SUFFIX
CASE 948AL



WLCSP-4
C4 SUFFIX
CASE 567JY

PIN CONFIGURATIONS (Top Views)

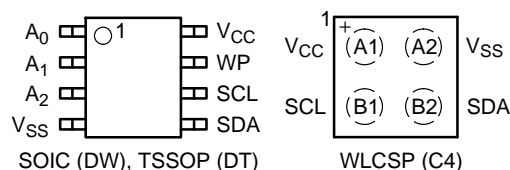

For the location of Pin 1, please consult the corresponding package drawing.

PIN FUNCTION

Pin Name	Function
A ₀ , A ₁ , A ₂	Device Address
SDA	Serial Data
SCL	Serial Clock
WP	Write Protect
V _{CC}	Power Supply
V _{SS}	Ground

ORDERING INFORMATION

See detailed ordering and shipping information in the package dimensions section on page 11 of this data sheet.

NV24C64

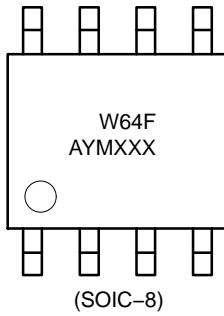

W64F = Specific Device Code
 A = Assembly Location
 Y = Production Year (Last Digit)
 M = Production Month (1–9, O, N, D)
 XXX = Last Three Digits of Assembly Lot Number

MARKING DIAGRAMS



(WLCSP-4)

V = Specific Device Code
 Y = Production Year
 W = Work Week

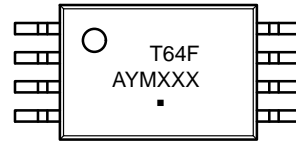

(TSSOP-8)

T64F = Specific Device Code
 A = Assembly Location
 Y = Production Year (Last Digit)
 M = Production Month (1–9, O, N, D)
 XXX = Last Three Digits of Assembly Lot Number
 ■ = Pb-Free Microdot

Table 1. ABSOLUTE MAXIMUM RATINGS

Parameters	Ratings	Units
Storage Temperature	–65 to +150	°C
Voltage on Any Pin with Respect to Ground (Note 1)	–0.5 to +6.5	V

Stresses exceeding those listed in the Maximum Ratings table may damage the device. If any of these limits are exceeded, device functionality should not be assumed, damage may occur and reliability may be affected.

1. The DC input voltage on any pin should not be lower than –0.5 V or higher than $V_{CC} + 0.5$ V. During transitions, the voltage on any pin may undershoot to no less than –1.5 V or overshoot to no more than $V_{CC} + 1.5$ V, for periods of less than 20 ns.

Table 2. RELIABILITY CHARACTERISTICS (Note 2)

Symbol	Parameter	Min	Units
N_{END} (Note 3)	Endurance	1,000,000	Program/Erase Cycles
T_{DR}	Data Retention	100	Years

2. These parameters are tested initially and after a design or process change that affects the parameter according to appropriate AEC-Q100 and JEDEC test methods.

3. Page Mode, $V_{CC} = 5$ V, 25°C.

Table 3. D.C. OPERATING CHARACTERISTICS ($V_{CC} = 1.7$ V to 5.5 V, $T_A = -40$ °C to +105°C, unless otherwise specified.)

Symbol	Parameter	Test Conditions	Min	Max	Units
I_{CCR}	Read Current	Read, $f_{SCL} = 1$ MHz		1	mA
I_{CCW}	Write Current	Write, $f_{SCL} = 1$ MHz		1	mA
I_{SB}	Standby Current	All I/O Pins at GND or V_{CC}		2	μA
I_L	I/O Pin Leakage	Pin at GND or V_{CC}		2	μA
V_{IL}	Input Low Voltage	SCL, SDA	–0.5	$V_{CC} \times 0.3$	V
V_{IH}	Input High Voltage	SCL, SDA	$V_{CC} \times 0.7$	$V_{CC} + 0.5$	V
V_{ILA}	Input Low Voltage	A2, A1, A0 and WP	–0.5	$V_{CC} \times 0.3$	V
V_{IHA}	Input High Voltage	A2, A1, A0 and WP	$V_{CC} \times 0.8$	$V_{CC} + 0.5$	V
V_{OL1}	Output Low Voltage	$V_{CC} \geq 2.5$ V, $I_{OL} = 3.0$ mA		0.4	V
V_{OL2}	Output Low Voltage	$V_{CC} < 2.5$ V, $I_{OL} = 1.0$ mA		0.2	V

NV24C64

Table 4. PIN IMPEDANCE CHARACTERISTICS ($V_{CC} = 1.7\text{ V to }5.5\text{ V}$, $T_A = -40^\circ\text{C to }+105^\circ\text{C}$, unless otherwise specified.)

Symbol	Parameter	Conditions	Min	Max	Units
C_{IN} (Note 4)	SDA I/O Pin Capacitance	$V_{IN} = 0\text{ V}$		8	pF
C_{IN} (Note 4)	Input Capacitance (other pins)	$V_{IN} = 0\text{ V}$		6	pF
R_{PD} (Note 5)	WP, A0, A1 or A2 On-Chip Pull-Down Resistor	$V_{IN} < V_{IHA}$	50		k Ω
I_{PD} (Note 5)	WP, A0, A1 or A2 On-Chip Pull-Down Current	$V_{IN} > V_{IHA}$		2	μA

- These parameters are tested initially and after a design or process change that affects the parameter according to appropriate AEC-Q100 and JEDEC test methods.
- For improved noise immunity (and to allow for floating input pins), the WP, A0, A1 & A2 inputs are pulled-down to GND by relatively strong on-chip resistors. When attempting to drive these inputs High, the external drivers must be able to supply sufficient current, until the input level at the pin exceeds V_{IHA} . Once the input level at the pin exceeds V_{IHA} , the resistive pull-down (R_{PD}) converts to a constant current pull-down (I_{PD}).

Table 5. A.C. CHARACTERISTICS ($V_{CC} = 1.7\text{ V to }5.5\text{ V}$, $T_A = -40^\circ\text{C to }+105^\circ\text{C}$) (Note 6)

Symbol	Parameter	Standard		Fast		Fast-Plus		Units
		Min	Max	Min	Max	Min	Max	
F_{SCL}	Clock Frequency		100		400		1,000	kHz
$t_{HD:STA}$	START Condition Hold Time	4		0.6		0.25		μs
t_{LOW}	Low Period of SCL Clock	4.7		1.3		0.45		μs
t_{HIGH}	High Period of SCL Clock	4		0.6		0.40		μs
$t_{SU:STA}$	START Condition Setup Time	4.7		0.6		0.25		μs
$t_{HD:DAT}$	Data In Hold Time	0		0		0		μs
$t_{SU:DAT}$	Data In Setup Time	250		100		50		ns
t_R (Note 7)	SDA and SCL Rise Time		1,000		300		100	ns
t_F (Note 7)	SDA and SCL Fall Time		300		300		100	ns
$t_{SU:STO}$	STOP Condition Setup Time	4		0.6		0.25		μs
t_{BUF}	Bus Free Time Between STOP and START	4.7		1.3		0.5		μs
t_{AA}	SCL Low to Data Out Valid		3.5		0.9		0.40	μs
t_{DH}	Data Out Hold Time	100		100		50		ns
T_i (Note 7)	Noise Pulse Filtered at SCL and SDA Inputs		100		100		100	ns
$t_{SU:WP}$	WP Setup Time	0		0		0		μs
$t_{HD:WP}$	WP Hold Time	2.5		2.5		1		μs
t_{WR}	Write Cycle Time		5		5		5	ms
t_{PU} (Notes 7, 8)	Power-up to Ready Mode		1		1	0.1	1	ms

Product parametric performance is indicated in the Electrical Characteristics for the listed test conditions, unless otherwise noted. Product performance may not be indicated by the Electrical Characteristics if operated under different conditions.

- Test conditions according to "A.C. Test Conditions" table.
- Tested initially and after a design or process change that affects this parameter.
- t_{PU} is the delay between the time V_{CC} is stable and the device is ready to accept commands.

Table 6. A.C. TEST CONDITIONS

Input Levels	$0.2 \times V_{CC}$ to $0.8 \times V_{CC}$ for $V_{CC} > 2.2\text{ V}$ and $0.15 \times V_{CC}$ to $0.85 \times V_{CC}$ for $V_{CC} < 2.2\text{ V}$
Input Rise and Fall Times	$\leq 50\text{ ns}$
Input Reference Levels	$0.3 \times V_{CC}$, $0.7 \times V_{CC}$
Output Reference Levels	$0.5 \times V_{CC}$
Output Load	Current Source: $I_{OL} = 3\text{ mA}$ ($V_{CC} \geq 2.2\text{ V}$); $I_{OL} = 1\text{ mA}$ ($V_{CC} < 2.2\text{ V}$); $C_L = 100\text{ pF}$

Power-On Reset (POR)

Each NV24C64 incorporates Power-On Reset (POR) circuitry which protects the internal logic against powering up in the wrong state. The device will power up into Standby mode after V_{CC} exceeds the POR trigger level and will power down into Reset mode when V_{CC} drops below the POR trigger level. This bi-directional POR behavior protects the device against ‘brown-out’ failure following a temporary loss of power.

Pin Description

SCL: The Serial Clock input pin accepts the clock signal generated by the Master.

SDA: The Serial Data I/O pin accepts input data and delivers output data. In transmit mode, this pin is open drain. Data is acquired on the positive edge, and is delivered on the negative edge of SCL.

A₀, A₁ and A₂: The Address inputs set the device address that must be matched by the corresponding Slave address bits. The Address inputs are hard-wired HIGH or LOW allowing for up to eight devices to be used (cascaded) on the same bus. When left floating, these pins are pulled LOW internally. The Address inputs are not available for use with WLCSP 4-bumps.

WP: When pulled HIGH, the Write Protect input pin inhibits all write operations. When left floating, this pin is pulled LOW internally. The WP input is not available for the WLCSP 4-bumps, therefore all write operations are allowed for the device in this package.

Functional Description

The NV24C64 supports the Inter-Integrated Circuit (I²C) Bus protocol. The protocol relies on the use of a Master device, which provides the clock and directs bus traffic, and Slave devices which execute requests. The NV24C64 operates as a Slave device. Both Master and Slave can

transmit or receive, but only the Master can assign those roles.

I²C Bus Protocol

The 2-wire I²C bus consists of two lines, SCL and SDA, connected to the V_{CC} supply via pull-up resistors. The Master provides the clock to the SCL line, and either the Master or the Slaves drive the SDA line. A ‘0’ is transmitted by pulling a line LOW and a ‘1’ by letting it stay HIGH. Data transfer may be initiated only when the bus is not busy (see A.C. Characteristics). During data transfer, SDA must remain stable while SCL is HIGH.

START/STOP Condition

An SDA transition while SCL is HIGH creates a START or STOP condition (Figure 2). The START consists of a HIGH to LOW SDA transition, while SCL is HIGH. Absent the START, a Slave will not respond to the Master. The STOP completes all commands, and consists of a LOW to HIGH SDA transition, while SCL is HIGH.

Device Addressing

The Master addresses a Slave by creating a START condition and then broadcasting an 8-bit Slave address. For the NV24C64, the first four bits of the Slave address are set to 1010 (Ah); the next three bits, A₂, A₁ and A₀, must match the logic state of the similarly named input pins. The devices in WLCSP 4-bumps respond only to the Slave Address with A₂ A₁ A₀ = 000 (NV24C64C4CTR) or to A₂ A₁ A₀ = 100 (NV24C64AC4CTR). The R/W bit tells the Slave whether the Master intends to read (1) or write (0) data (Figure 3).

Acknowledge

During the 9th clock cycle following every byte sent to the bus, the transmitter releases the SDA line, allowing the receiver to respond. The receiver then either acknowledges (ACK) by pulling SDA LOW, or does not acknowledge (NoACK) by letting SDA stay HIGH (Figure 4). Bus timing is illustrated in Figure 5.

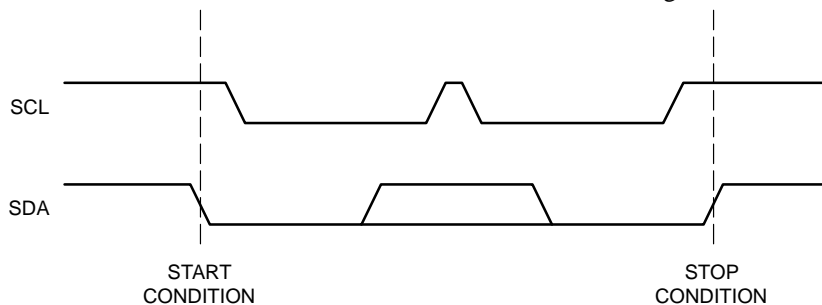
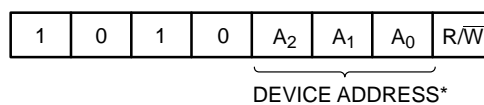

Figure 2. Start/Stop Timing



* The devices in WLCSP 4-bumps respond only to the Slave Address with: A₂ A₁ A₀ = 000, NV24C64C4UX4TG

Figure 3. Slave Address Bits

NV24C64

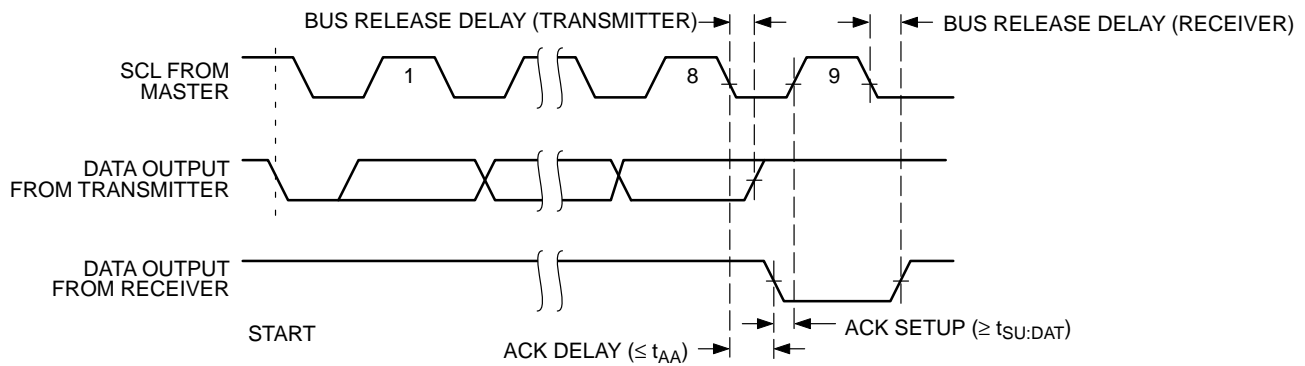

Figure 4. Acknowledge Timing

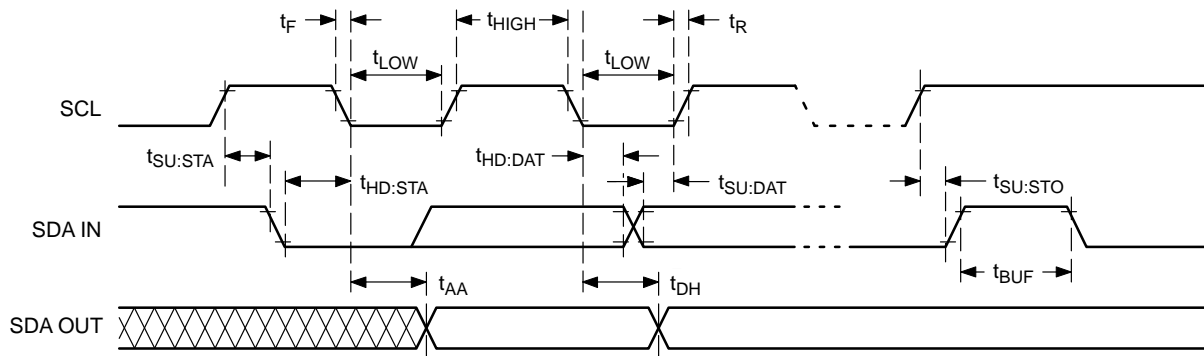

Figure 5. Bus Timing

WRITE OPERATIONS

Byte Write

To write data to memory, the Master creates a START condition on the bus and then broadcasts a Slave address with the R/\overline{W} bit set to '0'. The Master then sends two address bytes and a data byte and concludes the session by creating a STOP condition on the bus. The Slave responds with ACK after every byte sent by the Master (Figure 6). The STOP starts the internal Write cycle, and while this operation is in progress (t_{WR}), the SDA output is tri-stated and the Slave does not acknowledge the Master (Figure 7).

Page Write

The Byte Write operation can be expanded to Page Write, by sending more than one data byte to the Slave before issuing the STOP condition (Figure 8). Up to 32 distinct data bytes can be loaded into the internal Page Write Buffer starting at the address provided by the Master. The page address is latched, and as long as the Master keeps sending data, the internal byte address is incremented up to the end of page, where it then wraps around (within the page). New data can therefore replace data loaded earlier. Following the STOP, data loaded during the Page Write session will be written to memory in a single internal Write cycle (t_{WR}).

Acknowledge Polling

As soon (and as long) as internal Write is in progress, the Slave will not acknowledge the Master. This feature enables the Master to immediately follow-up with a new Read or Write request, rather than wait for the maximum specified Write time (t_{WR}) to elapse. Upon receiving a NoACK response from the Slave, the Master simply repeats the request until the Slave responds with ACK.

Hardware Write Protection

With the WP pin held HIGH, the entire memory is protected against Write operations. If the WP pin is left floating or is grounded, it has no impact on the Write operation. The state of the WP pin is strobed on the last falling edge of SCL immediately preceding the 1st data byte (Figure 9). If the WP pin is HIGH during the strobe interval, the Slave will not acknowledge the data byte and the Write request will be rejected.

Delivery State

The NV24C64 is shipped erased, i.e., all bytes are FFh.

NV24C64

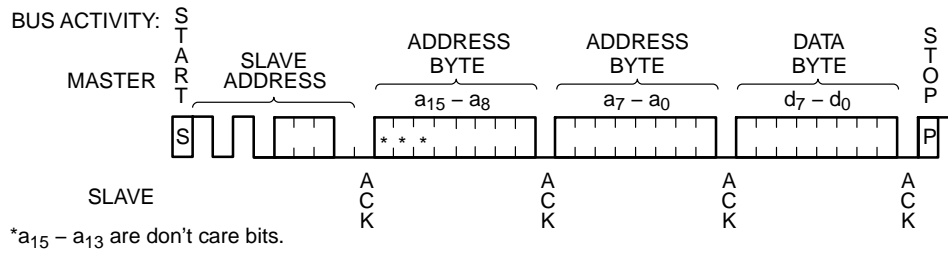

Figure 6. Byte Write Sequence

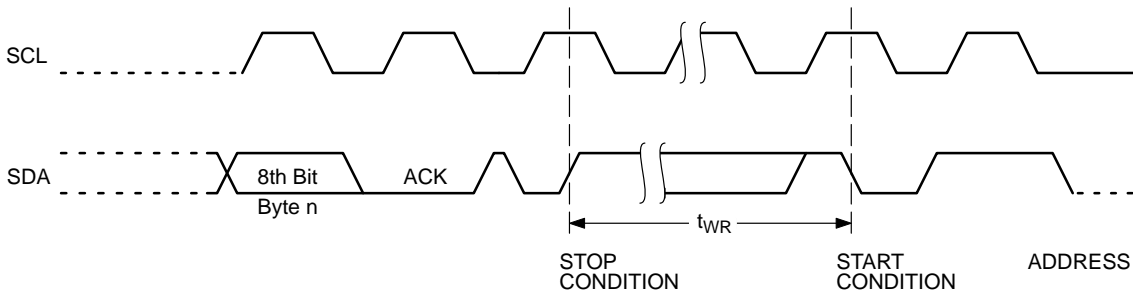

Figure 7. Write Cycle Timing

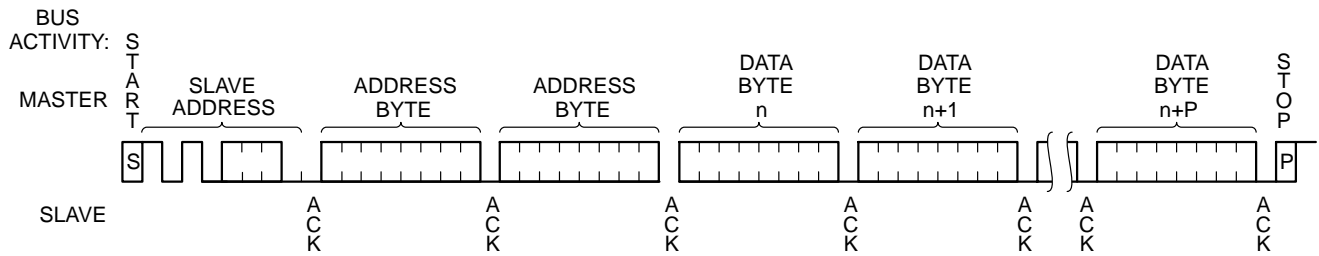

Figure 8. Page Write Sequence

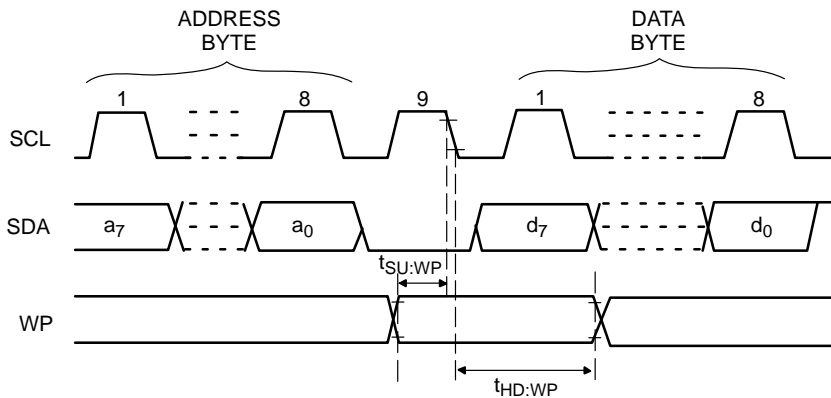

Figure 9. WP Timing

READ OPERATIONS

Immediate Read

To read data from memory, the Master creates a START condition on the bus and then broadcasts a Slave address with the R/\overline{W} bit set to '1'. The Slave responds with ACK and starts shifting out data residing at the current address. After receiving the data, the Master responds with NoACK and terminates the session by creating a STOP condition on the bus (Figure 10). The Slave then returns to Standby mode.

Selective Read

To read data residing at a specific address, the selected address must first be loaded into the internal address register. This is done by starting a Byte Write sequence, whereby the Master creates a START condition, then broadcasts a Slave address with the R/\overline{W} bit set to '0' and then sends two address bytes to the Slave. Rather than completing the Byte

Write sequence by sending data, the Master then creates a START condition and broadcasts a Slave address with the R/\overline{W} bit set to '1'. The Slave responds with ACK after every byte sent by the Master and then sends out data residing at the selected address. After receiving the data, the Master responds with NoACK and then terminates the session by creating a STOP condition on the bus (Figure 11).

Sequential Read

If, after receiving data sent by the Slave, the Master responds with ACK, then the Slave will continue transmitting until the Master responds with NoACK followed by STOP (Figure 12). During Sequential Read the internal byte address is automatically incremented up to the end of memory, where it then wraps around to the beginning of memory.

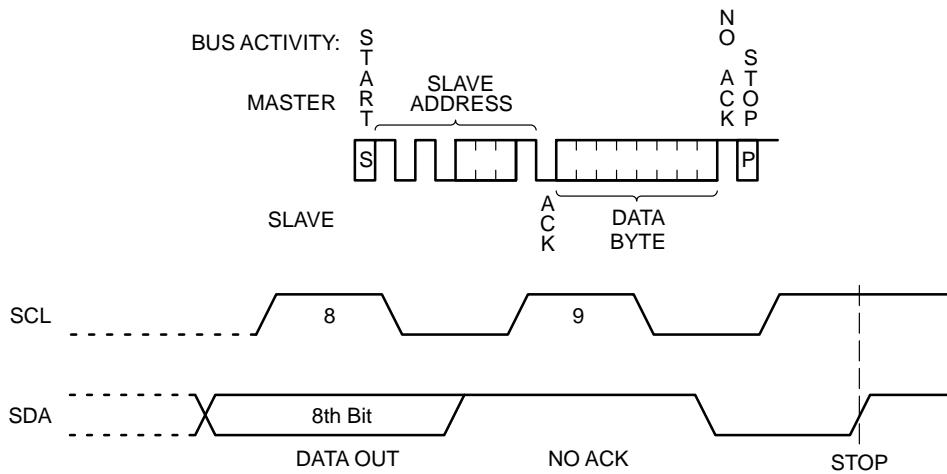

Figure 10. Immediate Read Sequence and Timing

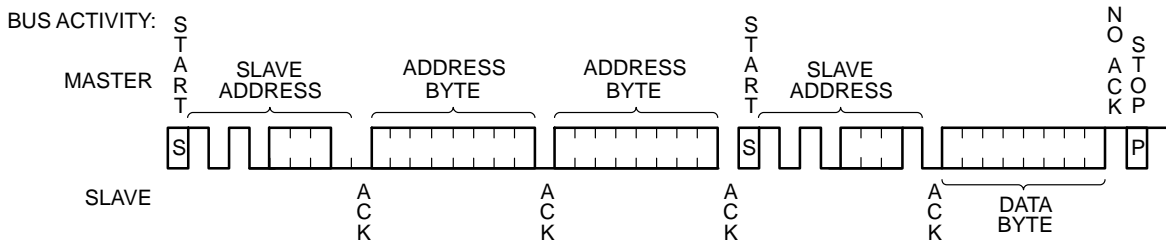

Figure 11. Selective Read Sequence

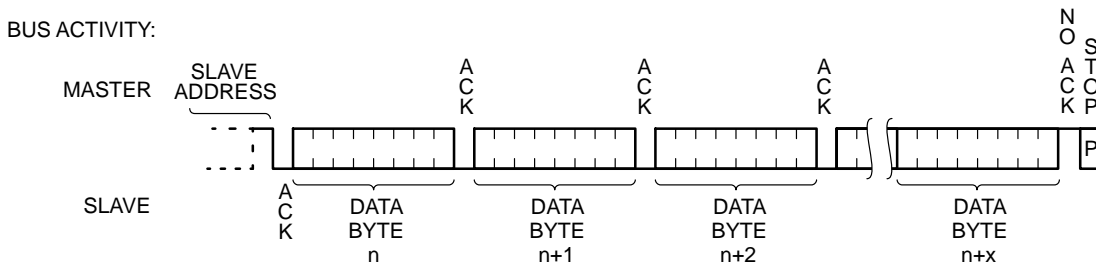
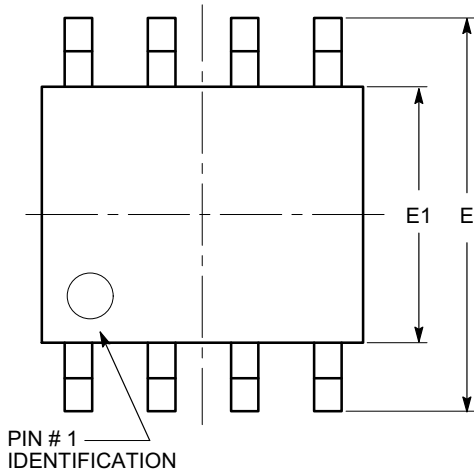

Figure 12. Sequential Read Sequence

NV24C64

PACKAGE DIMENSIONS

SOIC 8, 150 mils
CASE 751BD-01
ISSUE O



TOP VIEW

SYMBOL	MIN	NOM	MAX
A	1.35		1.75
A1	0.10		0.25
b	0.33		0.51
c	0.19		0.25
D	4.80		5.00
E	5.80		6.20
E1	3.80		4.00
e	1.27 BSC		
h	0.25		0.50
L	0.40		1.27
θ	0°		8°

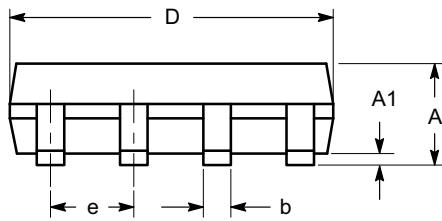

SIDE VIEW

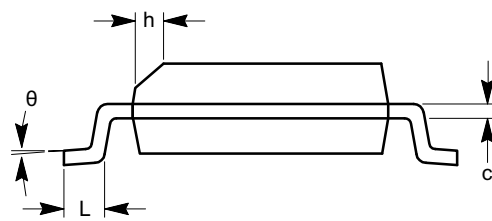

END VIEW

Notes:

- (1) All dimensions are in millimeters. Angles in degrees.
- (2) Complies with JEDEC MS-012.

NV24C64

PACKAGE DIMENSIONS

TSSOP8, 4.4x3
CASE 948AL-01
ISSUE O

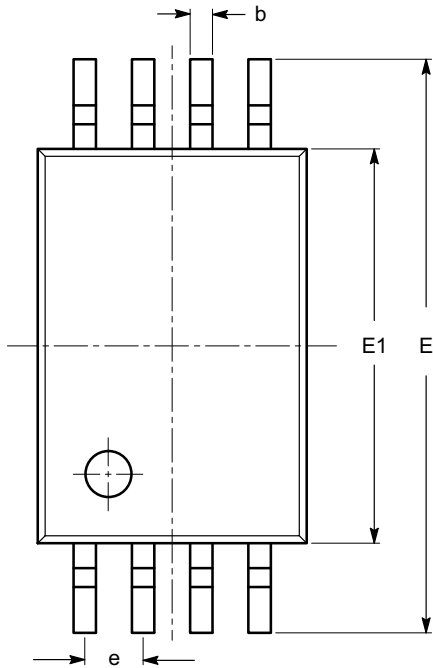

SYMBOL	MIN	NOM	MAX
A			1.20
A1	0.05		0.15
A2	0.80	0.90	1.05
b	0.19		0.30
c	0.09		0.20
D	2.90	3.00	3.10
E	6.30	6.40	6.50
E1	4.30	4.40	4.50
e	0.65 BSC		
L	1.00 REF		
L1	0.50	0.60	0.75
θ	0°		8°

TOP VIEW

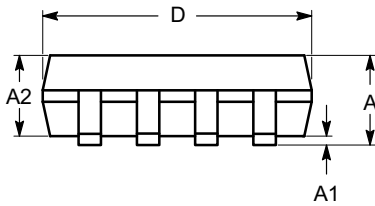

SIDE VIEW

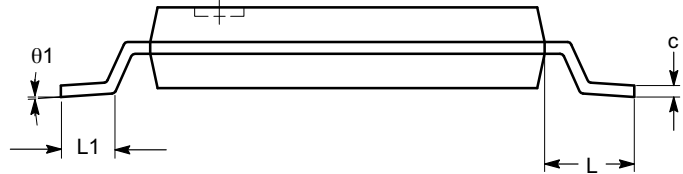

END VIEW

Notes:

- (1) All dimensions are in millimeters. Angles in degrees.
- (2) Complies with JEDEC MO-153.

NV24C64

PACKAGE DIMENSIONS

WLCSP4, 0.77x0.77
CASE 567JY
ISSUE B

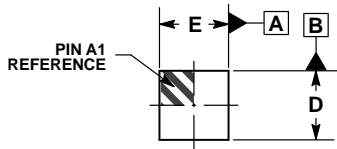

TOP VIEW

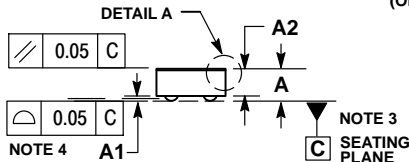

SIDE VIEW

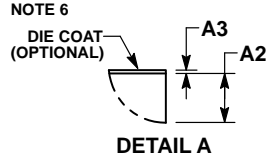

DETAIL A

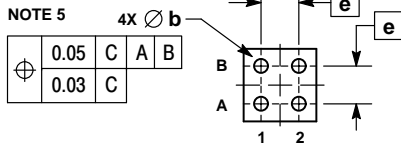

BOTTOM VIEW

NOTES:

1. DIMENSIONING AND TOLERANCING PER ASME Y14.5M, 1994.
2. CONTROLLING DIMENSION: MILLIMETERS.
3. DATUM C, THE SEATING PLANE, IS DEFINED BY THE SPHERICAL CROWNS OF THE SOLDER BALLS.
4. COPLANARITY APPLIES TO SPHERICAL CROWNS OF THE SOLDER BALLS.
5. DIMENSION b IS MEASURED AT THE MAXIMUM CONTACT BALL DIAMETER PARALLEL TO DATUM C.
6. BACKSIDE COATING IS OPTIONAL.

DIM	MILLIMETERS		
	MIN	NOM	MAX
A	---	---	0.35
A1	0.04	0.055	0.07
A2	0.255 REF		
A3	0.025 REF		
b	0.15	0.155	0.16
D	0.75	0.77	0.79
E	0.75	0.77	0.79
e	0.40 BSC		

RECOMMENDED SOLDERING FOOTPRINT*

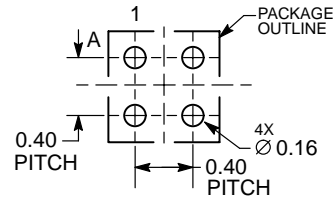

DIMENSIONS: MILLIMETERS

*For additional information on our Pb-Free strategy and soldering details, please download the ON Semiconductor Soldering and Mounting Techniques Reference Manual, SOLDERRM/D.

NV24C64

ORDERING INFORMATION

Device Order Number	Specific Device Marking	Package Type	Temperature Range	Lead Finish	Shipping
NV24C64DWUTG	W64F	SOIC-8, JEDEC	(-40°C to +105°C)	NiPdAu	Tape & Reel, 3,000 Units / Reel
NV24C64DTUTG	T64F	TSSOP-8	(-40°C to +105°C)	NiPdAu	Tape & Reel, 3,000 Units / Reel
NV24C64C4UX4TG	V	WLCSP-4 with Die Coat	(-40°C to +105°C)	SnAgCu (SAC)	Tape & Reel, 5,000 Units / Reel

9. All packages are RoHS-compliant (Lead-free, Halogen-free).
10. The standard lead finish is NiPdAu.
11. Contact factory for availability.
12. For information on tape and reel specifications, including part orientation and tape sizes, please refer to our Tape and Reel Packaging Specifications Brochure, BRD8011/D.
13. **Caution: The EEPROM devices delivered in WLCSP must never be exposed to ultra violet light. When exposed to ultra violet light the EEPROM cells lose their stored data.**

ON Semiconductor is licensed by Philips Corporation to carry the I²C Bus Protocol.

ON Semiconductor and  are trademarks of Semiconductor Components Industries, LLC dba ON Semiconductor or its subsidiaries in the United States and/or other countries. ON Semiconductor owns the rights to a number of patents, trademarks, copyrights, trade secrets, and other intellectual property. A listing of ON Semiconductor's product/patent coverage may be accessed at www.onsemi.com/site/pdf/Patent-Marking.pdf. ON Semiconductor reserves the right to make changes without further notice to any products herein. ON Semiconductor makes no warranty, representation or guarantee regarding the suitability of its products for any particular purpose, nor does ON Semiconductor assume any liability arising out of the application or use of any product or circuit, and specifically disclaims any and all liability, including without limitation special, consequential or incidental damages. Buyer is responsible for its products and applications using ON Semiconductor products, including compliance with all laws, regulations and safety requirements or standards, regardless of any support or applications information provided by ON Semiconductor. "Typical" parameters which may be provided in ON Semiconductor data sheets and/or specifications can and do vary in different applications and actual performance may vary over time. All operating parameters, including "Typicals" must be validated for each customer application by customer's technical experts. ON Semiconductor does not convey any license under its patent rights nor the rights of others. ON Semiconductor products are not designed, intended, or authorized for use as a critical component in life support systems or any FDA Class 3 medical devices or medical devices with a same or similar classification in a foreign jurisdiction or any devices intended for implantation in the human body. Should Buyer purchase or use ON Semiconductor products for any such unintended or unauthorized application, Buyer shall indemnify and hold ON Semiconductor and its officers, employees, subsidiaries, affiliates, and distributors harmless against all claims, costs, damages, and expenses, and reasonable attorney fees arising out of, directly or indirectly, any claim of personal injury or death associated with such unintended or unauthorized use, even if such claim alleges that ON Semiconductor was negligent regarding the design or manufacture of the part. ON Semiconductor is an Equal Opportunity/Affirmative Action Employer. This literature is subject to all applicable copyright laws and is not for resale in any manner.

PUBLICATION ORDERING INFORMATION

LITERATURE FULFILLMENT:

Literature Distribution Center for ON Semiconductor
19521 E. 32nd Pkwy, Aurora, Colorado 80011 USA
Phone: 303-675-2175 or 800-344-3860 Toll Free USA/Canada
Fax: 303-675-2176 or 800-344-3867 Toll Free USA/Canada
Email: orderlit@onsemi.com

N. American Technical Support: 800-282-9855 Toll Free
USA/Canada
Europe, Middle East and Africa Technical Support:
Phone: 421 33 790 2910
Japan Customer Focus Center
Phone: 81-3-5817-1050

ON Semiconductor Website: www.onsemi.com

Order Literature: <http://www.onsemi.com/orderlit>

For additional information, please contact your local Sales Representative