

NVB110N65S3F

MOSFET – Power, Single N-Channel, D2PAK

650 V, 110 mΩ, 30 A

Description

SUPERFET[®] III MOSFET is ON Semiconductor's brand-new high voltage super-junction (SJ) MOSFET family that is utilizing charge balance technology for outstanding low on-resistance and lower gate charge performance. This advanced technology is tailored to minimize conduction loss, provide superior switching performance, and withstand extreme dv/dt rate.

Consequently, SUPERFET III MOSFET is very suitable for the various power system for miniaturization and higher efficiency. SUPERFET III FRFET[®] MOSFET's optimized reverse recovery performance of body diode can remove additional component and improve system reliability.

Features

- 700 V @ $T_J = 150^\circ\text{C}$
- Typ. $R_{DS(on)} = 93\text{ m}\Omega$
- Ultra Low Gate Charge (Typ. $Q_g = 58\text{ nC}$)
- Low Effective Output Capacitance (Typ. $C_{oss(eff.)} = 533\text{ pF}$)
- 100% Avalanche Tested
- Qualified with AEC-Q101
- These Devices are Pb-Free and are RoHS Compliant

Typical Applications

- Automotive On Board Charger
- Automotive DC/DC Converter for HEV



ON Semiconductor[®]

www.onsemi.com

$V_{(BR)DSS}$	$R_{DS(ON)}\text{ MAX}$	$I_D\text{ MAX}$
650 V	110 mΩ @ 10 V	30 A

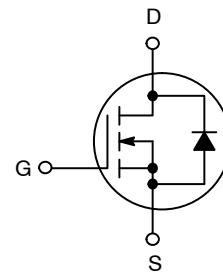

N-CHANNEL MOSFET

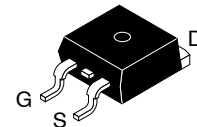

D²PAK-3
TO-263
CASE 418AJ

MARKING DIAGRAM

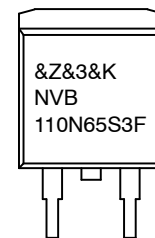

&Z = Assembly Plant Code
&3 = Data Code (Year & Week)
&K = Lot
NVB110N65S3F = Specific Device Code

ORDERING INFORMATION

See detailed ordering and shipping information on page 8 of this data sheet.

NVB110N65S3F

Table 1. ABSOLUTE MAXIMUM RATINGS ($T_C = 25^\circ\text{C}$ unless otherwise stated)

Symbol	Parameter	Value	Unit
V_{DSS}	Drain-to-Source Voltage	650	V
V_{GS}	Gate-to-Source Voltage	- DC	± 30
		- AC ($f > 1$ Hz)	± 30
I_D	Drain Current	- Continuous ($T_C = 25^\circ\text{C}$)	30
		- Continuous ($T_C = 100^\circ\text{C}$)	19.5
I_{DM}	Drain Current	- Pulsed (Note 1)	69
E_{AS}	Single Pulse Avalanche Energy (Note 2)	380	mJ
I_{AS}	Avalanche Current	3.5	A
E_{AR}	Repeated Avalanche Energy (Note 1)	2.4	mJ
dv/dt	MOSFET dv/dt	100	V/ns
	Peak Diode Recovery dv/dt (Note 3)	50	
P_D	Power Dissipation	$T_C = 25^\circ\text{C}$	240
		- Derate Above 25°C	1.92
T_J, T_{stg}	Operating Junction and Storage Temperature	-55 to 150	$^\circ\text{C}$
T_L	Maximum Lead Temperature for Soldering, 1/8" from Case for 5 Seconds	300	$^\circ\text{C}$

Stresses exceeding those listed in the Maximum Ratings table may damage the device. If any of these limits are exceeded, device functionality should not be assumed, damage may occur and reliability may be affected.

1. Repetitive rating: pulse – width limited by maximum junction temperature.
2. $I_{AS} = 3.5$ A, $R_G = 25$ Ω , starting $T_J = 25^\circ\text{C}$.
3. $ISD \leq 15$ A, $di/dt \leq 200$ A/_s, $V_{DD} \leq 400$ V, starting $T_C = 25^\circ\text{C}$.

Table 2. THERMAL RESISTANCE RATINGS

Symbol	Parameter	Max	Unit
$R_{\theta JC}$	Thermal Resistance, Junction-to-Case, Max.	0.52	$^\circ\text{C}/\text{W}$
$R_{\theta JA}$	Thermal Resistance, Junction-to-Ambient, Max.	40	

NVB110N65S3F

ELECTRICAL CHARACTERISTICS (T_C = 25°C unless otherwise noted)

Symbol	Parameter	Test Conditions	Min	Typ	Max	Unit
--------	-----------	-----------------	-----	-----	-----	------

OFF CHARACTERISTICS

BV _{DSS}	Drain-to-Source Breakdown Voltage	V _{GS} = 0 V, I _D = 1 mA, T _J = 25°C	650	-	-	V
		V _{GS} = 0 V, I _D = 10 mA, T _J = 150°C	700	-	-	V
ΔBV _{DSS} /ΔT _J	Breakdown Voltage Temperature Coefficient	I _D = 20 mA, Referenced to 25°C	-	0.61	-	V/°C
I _{DSS}	Zero Gate Voltage Drain Current	V _{DS} = 650 V, V _{GS} = 0 V	-	-	10	μA
		V _{DS} = 520 V, T _C = 125°C	-	128	-	μA
I _{GSS}	Gate-to-Body Leakage Current	V _{GS} = 0 V, I _D = 1 mA, T _J = 25°C	-	-	±100	nA

ON CHARACTERISTICS

V _{GS(th)}	Drain-to-Source Breakdown Voltage	V _{GS} = V _{DS} , I _D = 3 mA	3.0	-	5.0	V
R _{DS(on)}	Static Drain-to-Source On Resistance	V _{GS} = 10 V, I _D = 15 A	-	93	110	mΩ
g _{FS}	Forward Transconductance	V _{GS} = 20 V, I _D = 15 A	-	17	-	S

DYNAMIC CHARACTERISTICS

C _{iss}	Input Capacitance	V _{DS} = 400 V, V _{GS} = 0 V, f = 1 MHz	-	2560	-	pF
C _{oss}	Output Capacitance		-	50	-	pF
C _{oss(eff.)}	Effective Output Capacitance	V _{DS} = 0 to 400 V, V _{GS} = 0 V	-	553	-	pF
C _{oss(er.)}	Energy Related Output Capacitance	V _{DS} = 0 to 400 V, V _{GS} = 0 V	-	83	-	pF
Q _{g(total)}	Total Gate Charge at 10 V	V _{DS} = 400 V, I _D = 15 A, V _{GS} = 10 V (Note 4)	-	58	-	nC
Q _{gs}	Gate-to-Source Gate Charge		-	19	-	nC
Q _{gd}	Gate-to-Drain "Miller" Charge		-	23	-	nC
ESR	Equivalent Series Resistance	F = 1 MHz	-	2	-	Ω

SWITCHING CHARACTERISTICS, V_{GS} = 10 V

t _{d(on)}	Turn-On Delay Time	V _{DD} = 400 V, I _D = 15 A, V _{GS} = 10 V, R _G = 4.7 Ω (Note 4)	-	29	-	ns
t _r	Rise Time		-	32	-	ns
t _{d(off)}	Turn-Off Delay Time		-	61	-	ns
t _f	Fall Time		-	16	-	ns

SOURCE-DRAIN DIODE CHARACTERISTICS

I _S	Maximum Continuous Source-to-Drain Diode Forward Current	-	-	30	A	
I _{SM}	Maximum Pulsed Source-to-Drain Diode Forward Current	-	-	69	A	
V _{SD}	Source-to-Drain Diode Forward Voltage	V _{GS} = 0 V, I _{SD} = 15 A	-	-	1.3	V
t _{rr}	Reverse-Recovery Time	V _{GS} = 0 V, I _{SD} = 15 A, dI _F /dt = 100 A/μs	-	94	-	ns
Q _{rr}	Reverse-Recovery Charge		-	343	-	nC

Product parametric performance is indicated in the Electrical Characteristics for the listed test conditions, unless otherwise noted. Product performance may not be indicated by the Electrical Characteristics if operated under different conditions.

4. Essentially independent of operating temperature typical characteristics.

TYPICAL CHARACTERISTICS

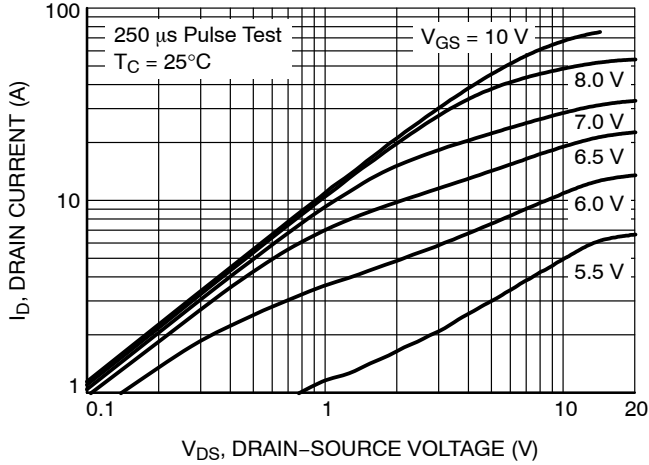

Figure 1. On-Region Characteristics
25°C

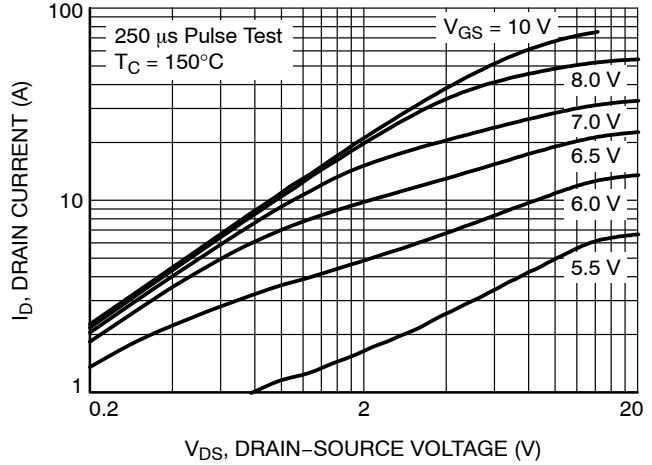

Figure 2. On-Region Characteristics
150°C

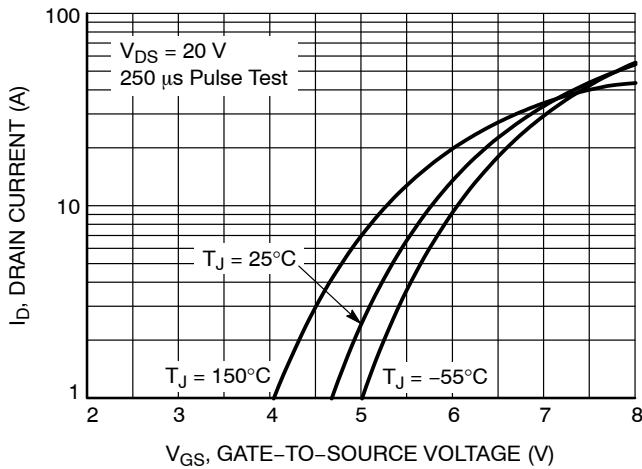

Figure 3. Transfer Characteristics

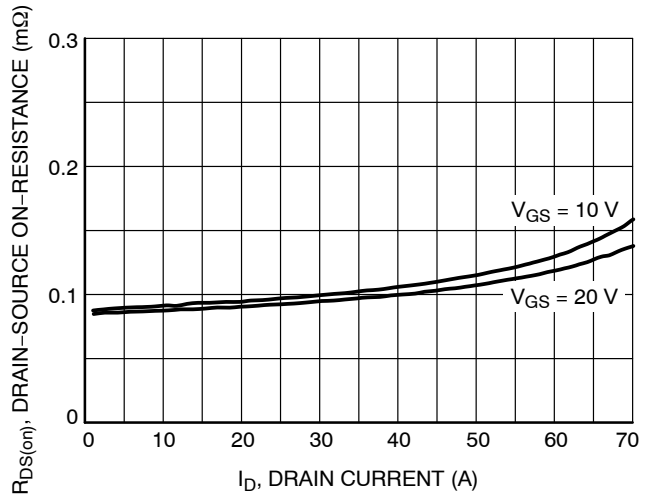

Figure 4. On-Resistance Variation vs. Drain Current and Gate Voltage

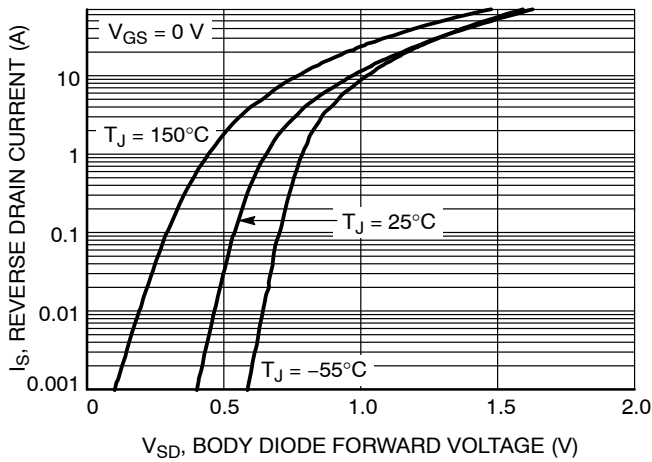

Figure 5. Body Diode Forward Voltage Variation vs. Source Current and Temperature

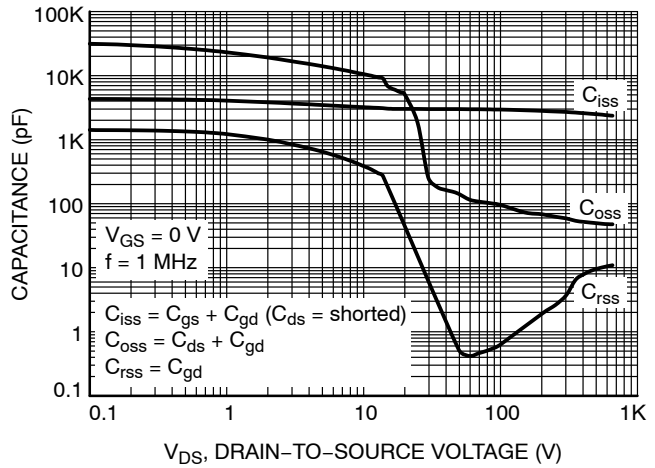

Figure 6. Capacitance Characteristics

TYPICAL CHARACTERISTICS

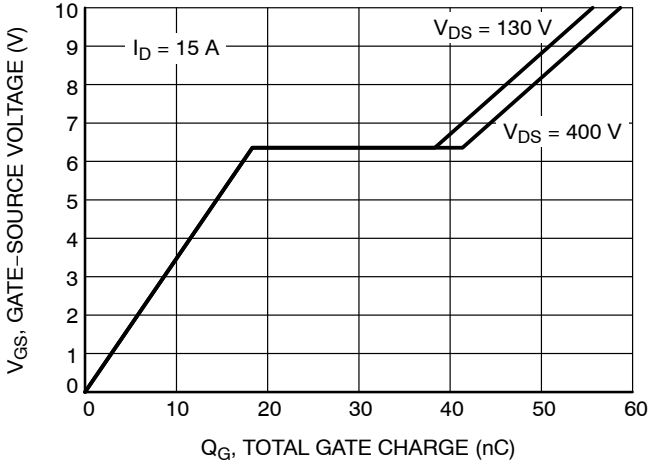

Figure 7. Gate Charge Characteristics

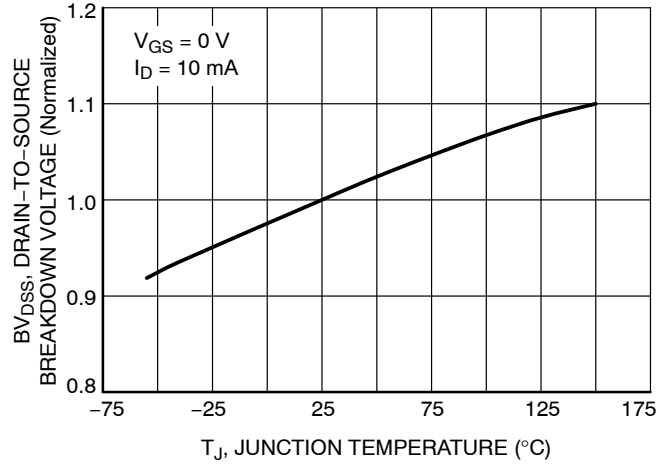

Figure 8. Breakdown Voltage Variation vs. Temperature

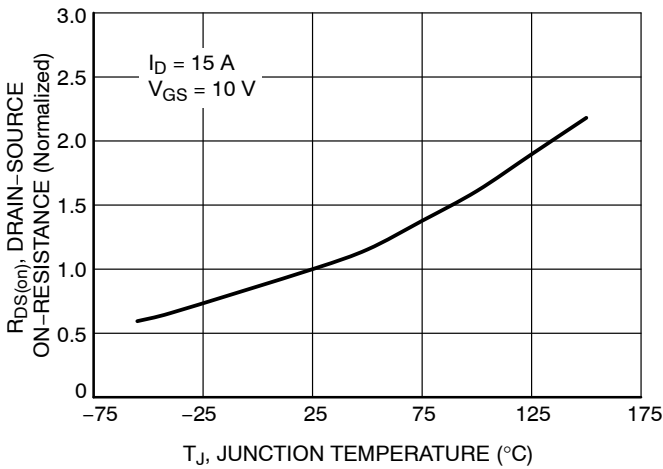

Figure 9. On-Resistance Variation vs. Temperature

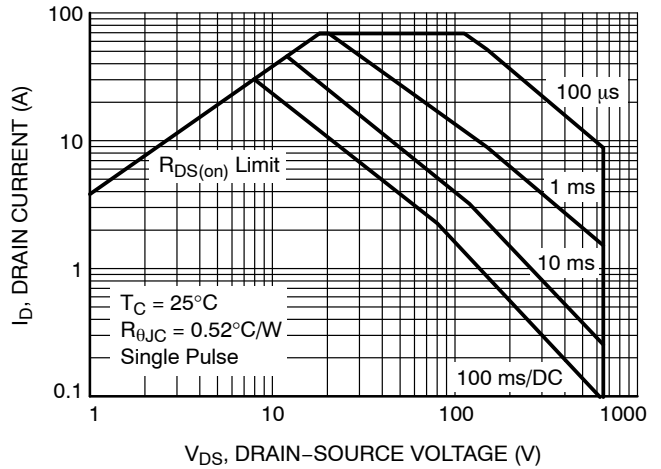

Figure 10. Maximum Safe Operating Area

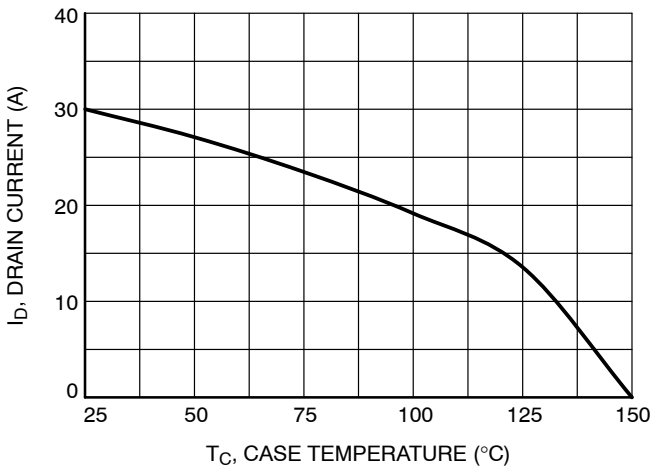

Figure 11. Maximum Drain Current vs. Case Temperature

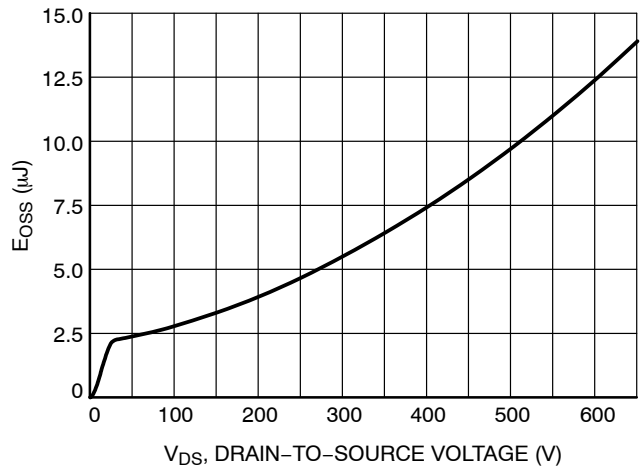

Figure 12. E_{OSS} vs. Drain-to-Source Voltage

TYPICAL CHARACTERISTICS

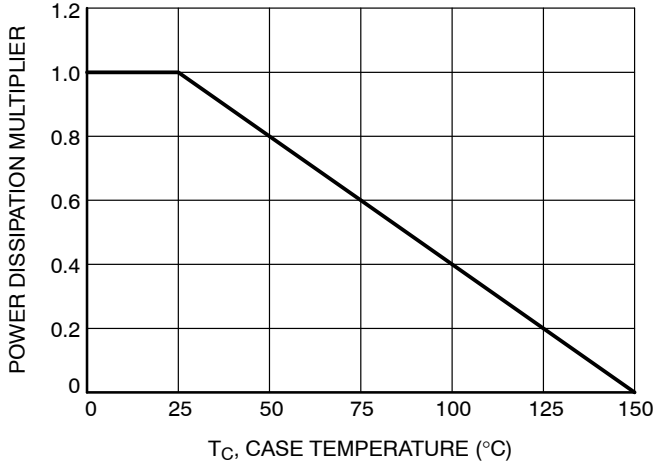

Figure 13. Normalized Power Dissipation vs. Case Temperature

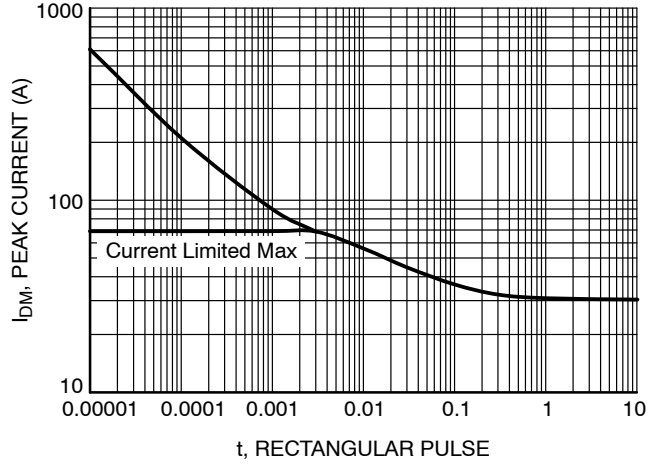

Figure 14. Peak Current Capability

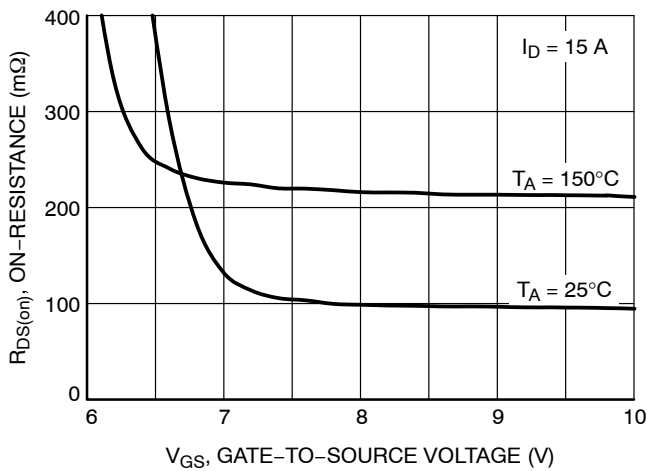

Figure 15. R_{DS(on)} vs. Gate Voltage

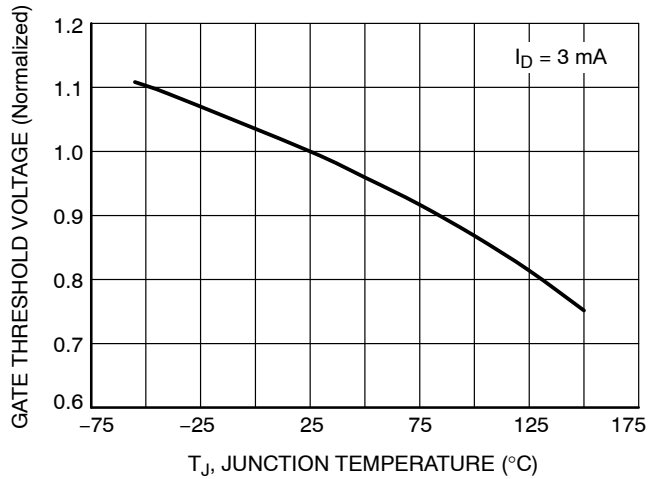

Figure 16. Normalized Gate Threshold Voltage vs. Temperature

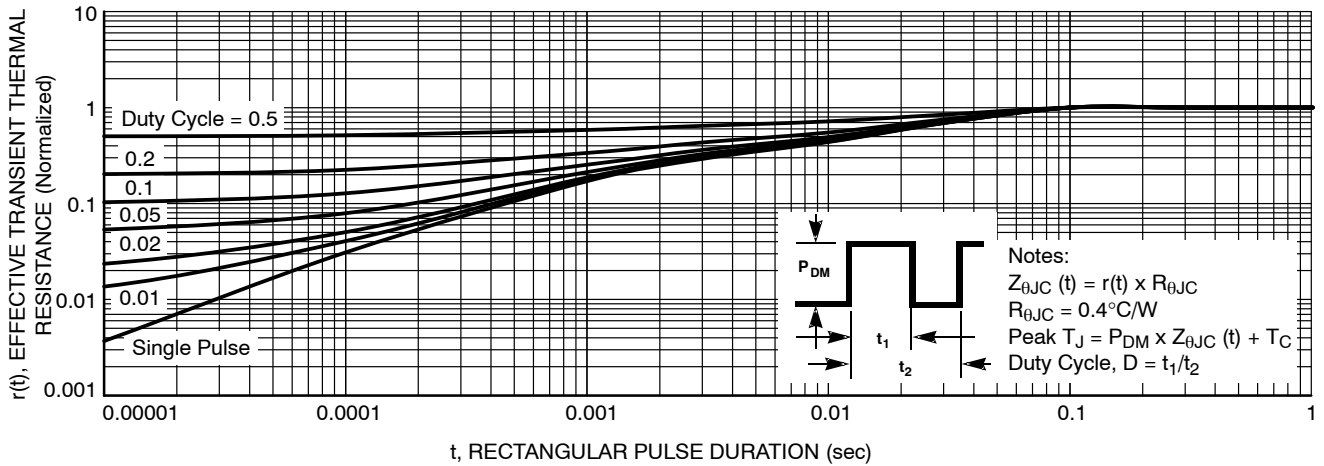
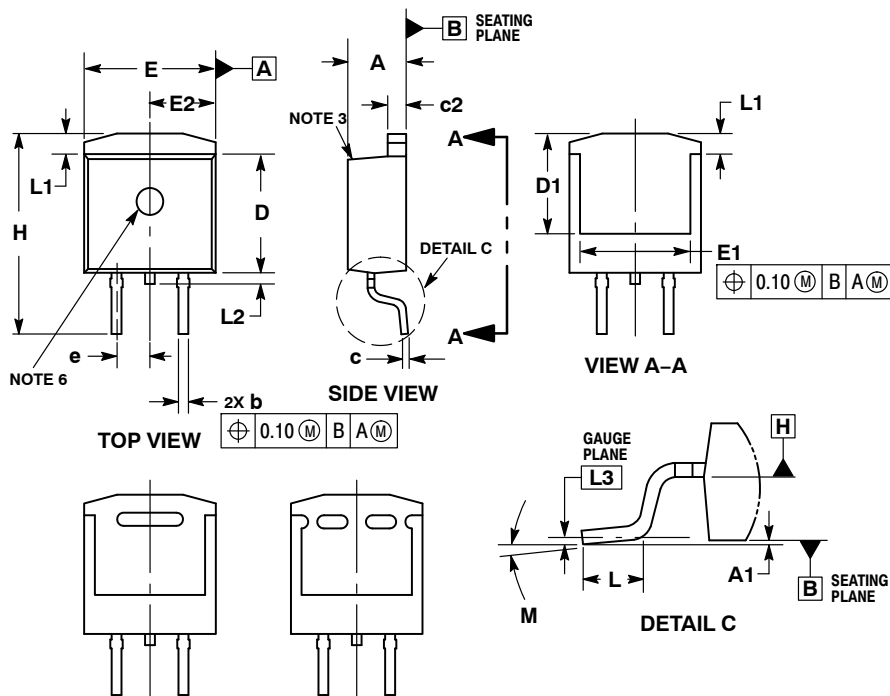

Figure 17. Transient Thermal Response

NVB110N65S3F

PACKAGE DIMENSIONS

D²PAK-3 (TO-263, 3-LEAD)
CASE 418AJ
ISSUE B



NOTES:

1. DIMENSIONING AND TOLERANCING PER ASME Y14.5M, 1994.
2. CONTROLLING DIMENSION: INCHES.
3. CHAMFER OPTIONAL
4. DIMENSIONS D AND E DO NOT INCLUDE MOLD FLASH. MOLD FLASH SHALL NOT EXCEED 0.005 PER SIDE. THESE DIMENSIONS ARE MEASURED AT THE OUTERMOST EXTREMES OF THE PLASTIC BODY AT DATUM H.
5. THERMAL PAD CONTOUR IS OPTIONAL WITHIN DIMENSIONS E, L1, D1 AND E1.
6. OPTIONAL MOLD FEATURE

DIM	INCHES		MILLIMETERS	
	MIN	MAX	MIN	MAX
A	0.160	0.190	4.06	4.83
A1	0.000	0.010	0.00	0.25
b	0.020	0.039	0.51	0.99
c	0.012	0.029	0.30	0.74
c2	0.045	0.065	1.14	1.65
D	0.330	0.380	8.38	9.65
D1	0.260	----	6.60	----
E	0.380	0.420	9.65	10.67
E1	0.245	----	6.22	----
e	0.100 BSC		2.54 BSC	
H	0.575	0.625	14.60	15.88
L	0.070	0.110	1.78	2.79
L1	----	0.066	----	1.68
L2	----	0.070	----	1.78
L3	0.010 BSC		0.25 BSC	
M	0°	8°	0°	8°

VIEW A-A
OPTIONAL CONSTRUCTIONS

RECOMMENDED SOLDERING FOOTPRINT*

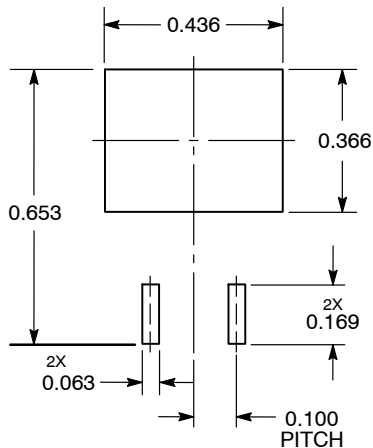

DIMENSIONS: INCHES

*For additional information on our Pb-Free strategy and soldering details, please download the ON Semiconductor Soldering and Mounting Techniques Reference Manual, SOLDERRM/D.

NVB110N65S3F

PACKAGE MARKING AND ORDERING INFORMATION

Part Number	Top Marking	Package	Packing Method	Reel Size	Tape Width	Quantity
NVB110N65S3F	NVB110N65S3F	D ² PAK	Tape & Reel†	330 mm	24 mm	800 Units

†For information on tape and reel specifications, including part orientation and tape sizes, please refer to our Tape and Reel Packaging Specifications Brochure, [BRD8011/D](#).

SUPERFET and FRFET are registered trademarks of Semiconductor Components Industries, LLC.

ON Semiconductor and  are trademarks of Semiconductor Components Industries, LLC dba ON Semiconductor or its subsidiaries in the United States and/or other countries. ON Semiconductor owns the rights to a number of patents, trademarks, copyrights, trade secrets, and other intellectual property. A listing of ON Semiconductor's product/patent coverage may be accessed at www.onsemi.com/site/pdf/Patent-Marking.pdf. ON Semiconductor reserves the right to make changes without further notice to any products herein. ON Semiconductor makes no warranty, representation or guarantee regarding the suitability of its products for any particular purpose, nor does ON Semiconductor assume any liability arising out of the application or use of any product or circuit, and specifically disclaims any and all liability, including without limitation special, consequential or incidental damages. Buyer is responsible for its products and applications using ON Semiconductor products, including compliance with all laws, regulations and safety requirements or standards, regardless of any support or applications information provided by ON Semiconductor. "Typical" parameters which may be provided in ON Semiconductor data sheets and/or specifications can and do vary in different applications and actual performance may vary over time. All operating parameters, including "Typicals" must be validated for each customer application by customer's technical experts. ON Semiconductor does not convey any license under its patent rights nor the rights of others. ON Semiconductor products are not designed, intended, or authorized for use as a critical component in life support systems or any FDA Class 3 medical devices or medical devices with a same or similar classification in a foreign jurisdiction or any devices intended for implantation in the human body. Should Buyer purchase or use ON Semiconductor products for any such unintended or unauthorized application, Buyer shall indemnify and hold ON Semiconductor and its officers, employees, subsidiaries, affiliates, and distributors harmless against all claims, costs, damages, and expenses, and reasonable attorney fees arising out of, directly or indirectly, any claim of personal injury or death associated with such unintended or unauthorized use, even if such claim alleges that ON Semiconductor was negligent regarding the design or manufacture of the part. ON Semiconductor is an Equal Opportunity/Affirmative Action Employer. This literature is subject to all applicable copyright laws and is not for resale in any manner.

PUBLICATION ORDERING INFORMATION

LITERATURE FULFILLMENT:

Literature Distribution Center for ON Semiconductor
19521 E. 32nd Pkwy, Aurora, Colorado 80011 USA
Phone: 303-675-2175 or 800-344-3860 Toll Free USA/Canada
Fax: 303-675-2176 or 800-344-3867 Toll Free USA/Canada
Email: orderlit@onsemi.com

N. American Technical Support: 800-282-9855 Toll Free
USA/Canada
Europe, Middle East and Africa Technical Support:
Phone: 421 33 790 2910

ON Semiconductor Website: www.onsemi.com

Order Literature: <http://www.onsemi.com/orderlit>

For additional information, please contact your local Sales Representative