

# NVD5C688NL

## Power MOSFET

60 V, 27.4 mΩ, 17 A, Single N-Channel

### Features

- Low  $R_{DS(on)}$  to Minimize Conduction Losses
- Low  $Q_G$  and Capacitance to Minimize Driver Losses
- AEC-Q101 Qualified and PPAP Capable
- These Devices are Pb-Free, Halogen Free/BFR Free and are RoHS Compliant

### MAXIMUM RATINGS ( $T_J = 25^\circ\text{C}$ unless otherwise noted)

Parameter	Symbol	Value	Unit	
Drain-to-Source Voltage	$V_{DSS}$	60	V	
Gate-to-Source Voltage	$V_{GS}$	$\pm 16$	V	
Continuous Drain Current $R_{\theta JC}$ (Notes 1 & 3)	Steady State	$T_C = 25^\circ\text{C}$	17	A
		$T_C = 100^\circ\text{C}$	12	
Power Dissipation $R_{\theta JC}$ (Note 1)	Steady State	$T_C = 25^\circ\text{C}$	18	W
		$T_C = 100^\circ\text{C}$	9.0	
Continuous Drain Current $R_{\theta JA}$ (Notes 1, 2 & 3)	Steady State	$T_A = 25^\circ\text{C}$	7.0	A
		$T_A = 100^\circ\text{C}$	5.0	
Power Dissipation $R_{\theta JA}$ (Notes 1 & 2)	Steady State	$T_A = 25^\circ\text{C}$	2.9	W
		$T_A = 100^\circ\text{C}$	1.45	
Pulsed Drain Current	$T_A = 25^\circ\text{C}, t_p = 10 \mu\text{s}$	$I_{DM}$	77	A
Operating Junction and Storage Temperature	$T_J, T_{stg}$	-55 to 175	$^\circ\text{C}$	
Source Current (Body Diode)	$I_S$	20	A	
Single Pulse Drain-to-Source Avalanche Energy ( $T_J = 25^\circ\text{C}, I_{L(pk)} = 1 \text{ A}$ )	$E_{AS}$	48	mJ	
Lead Temperature for Soldering Purposes (1/8" from case for 10 s)	$T_L$	260	$^\circ\text{C}$	

Stresses exceeding those listed in the Maximum Ratings table may damage the device. If any of these limits are exceeded, device functionality should not be assumed, damage may occur and reliability may be affected.

### THERMAL RESISTANCE MAXIMUM RATINGS

Parameter	Symbol	Value	Unit
Junction-to-Case (Drain) (Note 1)	$R_{\theta JC}$	8.05	$^\circ\text{C}/\text{W}$
Junction-to-Ambient - Steady State (Note 2)	$R_{\theta JA}$	51.6	

1. The entire application environment impacts the thermal resistance values shown, they are not constants and are only valid for the particular conditions noted.
2. Surface-mounted on FR4 board using a 650 mm<sup>2</sup>, 2 oz. Cu pad.
3. Maximum current for pulses as long as 1 second is higher but is dependent on pulse duration and duty cycle.



ON Semiconductor®

[www.onsemi.com](http://www.onsemi.com)

$V_{(BR)DSS}$	$R_{DS(on)}$	$I_D$
60 V	27.4 mΩ @ 10 V	17 A
	40 mΩ @ 4.5 V	

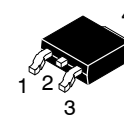
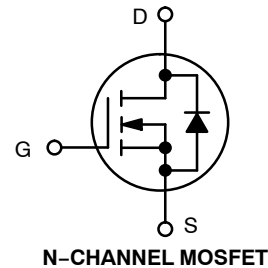

DPAK  
CASE 369C  
STYLE 2

### MARKING DIAGRAM & PIN ASSIGNMENT

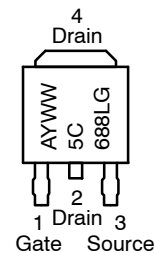

- A = Assembly Location
- Y = Year
- WW = Work Week
- 5C688L = Device Code
- G = Pb-Free Package

### ORDERING INFORMATION

See detailed ordering and shipping information in the package dimensions section on page 5 of this data sheet.

# NVD5C688NL

## ELECTRICAL CHARACTERISTICS (T<sub>J</sub> = 25°C unless otherwise noted)

Parameter	Symbol	Test Condition	Min	Typ	Max	Unit
-----------	--------	----------------	-----	-----	-----	------

### OFF CHARACTERISTICS

Drain-to-Source Breakdown Voltage	V <sub>(BR)DSS</sub>	V <sub>GS</sub> = 0 V, I <sub>D</sub> = 250 μA	60			V
Drain-to-Source Breakdown Voltage Temperature Coefficient	V <sub>(BR)DSS</sub> /T <sub>J</sub>			27		mV/°C
Zero Gate Voltage Drain Current	I <sub>DSS</sub>	V <sub>GS</sub> = 0 V, V <sub>DS</sub> = 60 V	T <sub>J</sub> = 25°C		10	μA
			T <sub>J</sub> = 125°C		250	
Gate-to-Source Leakage Current	I <sub>GSS</sub>	V <sub>DS</sub> = 0 V, V <sub>GS</sub> = 20 V			100	nA

### ON CHARACTERISTICS (Note 4)

Gate Threshold Voltage	V <sub>GS(TH)</sub>	V <sub>GS</sub> = V <sub>DS</sub> , I <sub>D</sub> = 15 μA	1.2		2.1	V
Negative Threshold Temperature Coefficient	V <sub>GS(TH)</sub> /T <sub>J</sub>			4.4		mV/°C
Drain-to-Source On Resistance	R <sub>DS(on)</sub>	V <sub>GS</sub> = 10 V, I <sub>D</sub> = 10 A		22.8	27.4	mΩ
		V <sub>GS</sub> = 4.5 V, I <sub>D</sub> = 10 A		32	40	
Forward Transconductance	g <sub>FS</sub>	V <sub>DS</sub> = 5 V, I <sub>D</sub> = 10 A		20		S

### CHARGES, CAPACITANCES AND GATE RESISTANCES

Input Capacitance	C <sub>iss</sub>	V <sub>GS</sub> = 0 V, f = 1.0 MHz, V <sub>DS</sub> = 25 V		400		pF
Output Capacitance	C <sub>oss</sub>			170		
Reverse Transfer Capacitance	C <sub>rss</sub>			12		
Total Gate Charge	Q <sub>G(TOT)</sub>	V <sub>DS</sub> = 48 V, I <sub>D</sub> = 10 A	V <sub>GS</sub> = 4.5 V	3.4		nC
			V <sub>GS</sub> = 10 V	7.0		
Threshold Gate Charge	Q <sub>G(TH)</sub>	V <sub>GS</sub> = 4.5 V, V <sub>DS</sub> = 48 V, I <sub>D</sub> = 10 A		0.9		nC
Gate-to-Source Charge	Q <sub>GS</sub>			1.5		
Gate-to-Drain Charge	Q <sub>GD</sub>			1.1		
Plateau Voltage	V <sub>GP</sub>			2.9		

### SWITCHING CHARACTERISTICS (Note 5)

Turn-On Delay Time	t <sub>d(on)</sub>	V <sub>GS</sub> = 4.5 V, V <sub>DS</sub> = 48 V, I <sub>D</sub> = 10 A, R <sub>G</sub> = 2.5 Ω		8		ns
Rise Time	t <sub>r</sub>			42		
Turn-Off Delay Time	t <sub>d(off)</sub>			11		
Fall Time	t <sub>f</sub>			24		

### DRAIN-SOURCE DIODE CHARACTERISTICS

Forward Diode Voltage	V <sub>SD</sub>	V <sub>GS</sub> = 0 V, I <sub>S</sub> = 10 A	T <sub>J</sub> = 25°C		0.9	1.2	V
			T <sub>J</sub> = 125°C		0.8		
Reverse Recovery Time	t <sub>RR</sub>	V <sub>GS</sub> = 0 V, dI <sub>S</sub> /dt = 100 A/μs, I <sub>S</sub> = 10 A		17		ns	
Charge Time	t <sub>a</sub>			8			
Discharge Time	t <sub>b</sub>			9			
Reverse Recovery Charge	Q <sub>RR</sub>			10			nC

4. Pulse Test: Pulse Width ≤ 300 μs, Duty Cycle ≤ 2%.

5. Switching characteristics are independent of operating junction temperatures.

TYPICAL CHARACTERISTICS

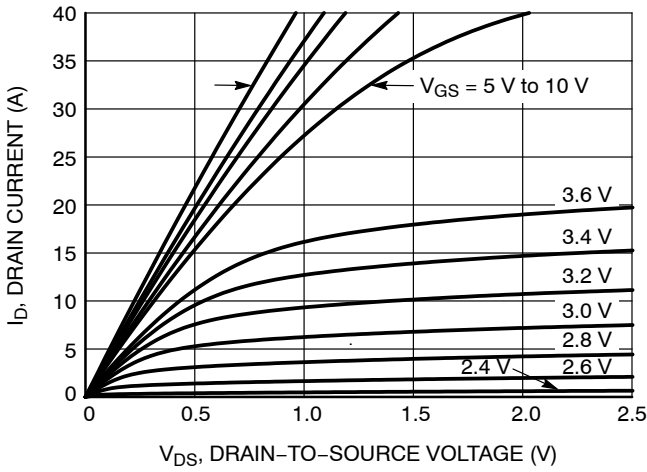

Figure 1. On-Region Characteristics

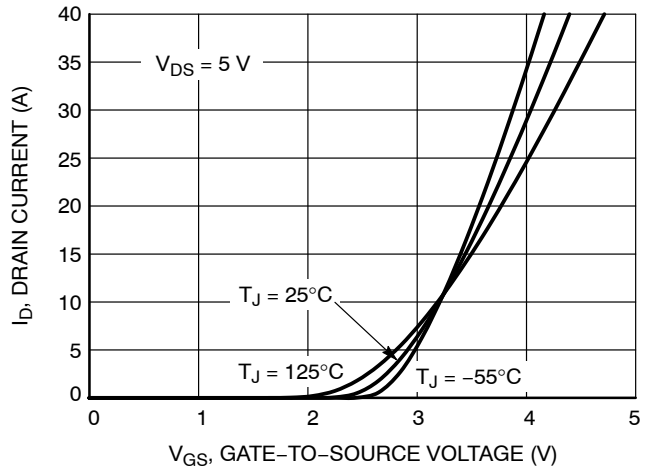

Figure 2. Transfer Characteristics

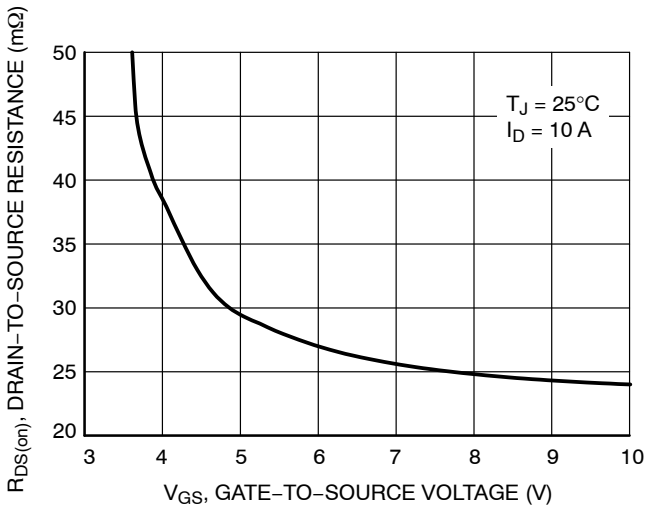

Figure 3. On-Resistance vs. Gate-to-Source Voltage

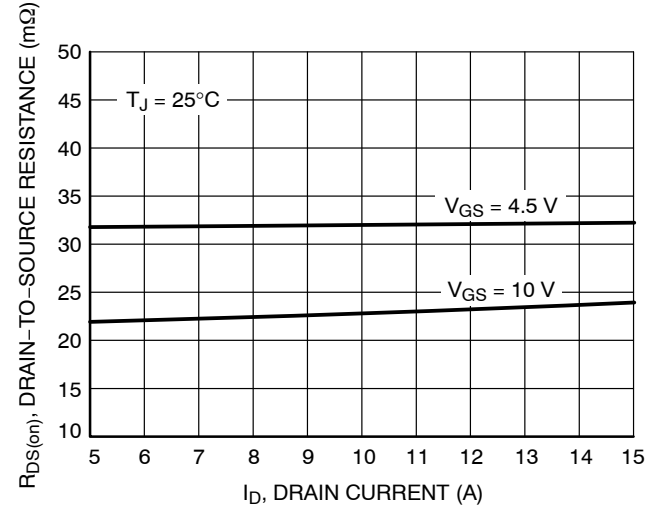

Figure 4. On-Resistance vs. Drain Current and Gate Voltage

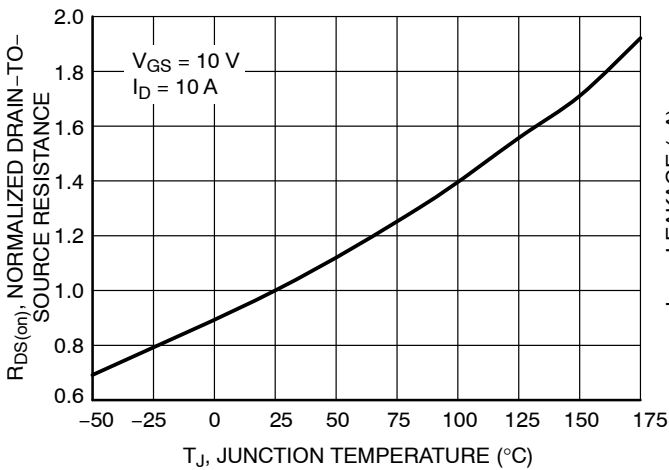

Figure 5. On-Resistance Variation with Temperature

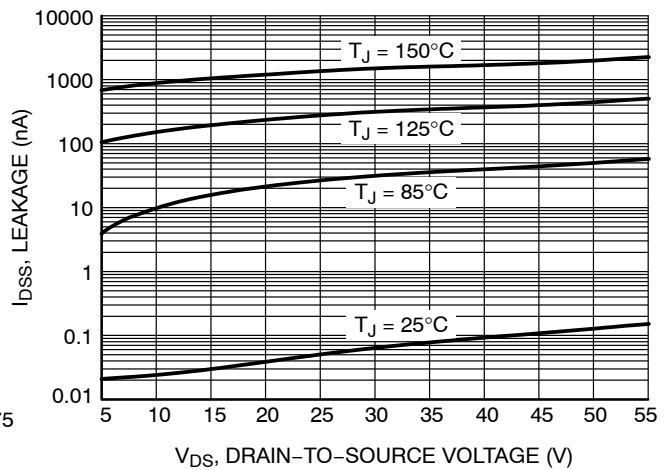

Figure 6. Drain-to-Source Leakage Current vs. Voltage

# NVD5C688NL

## TYPICAL CHARACTERISTICS

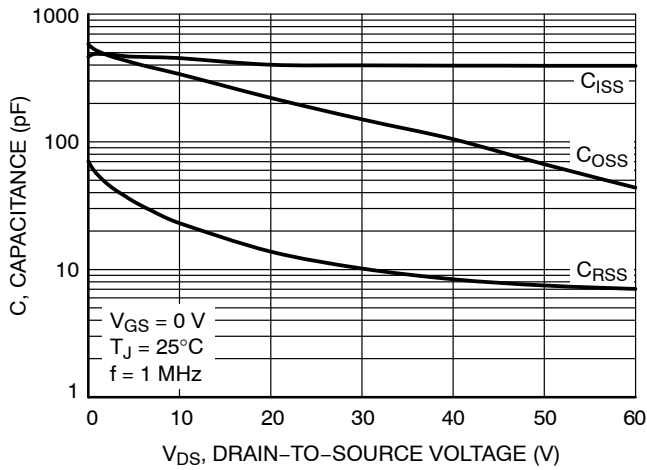

Figure 7. Capacitance Variation

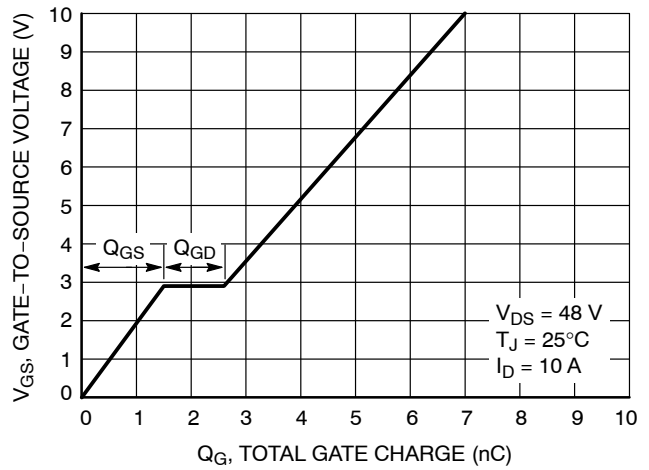

Figure 8. Gate-to-Source vs. Total Charge

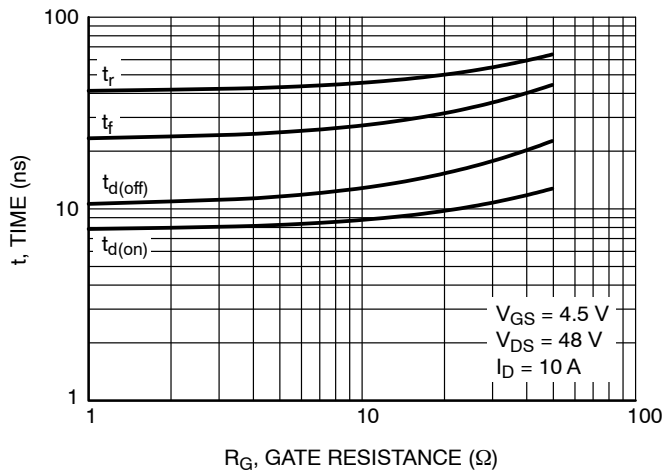

Figure 9. Resistive Switching Time Variation vs. Gate Resistance

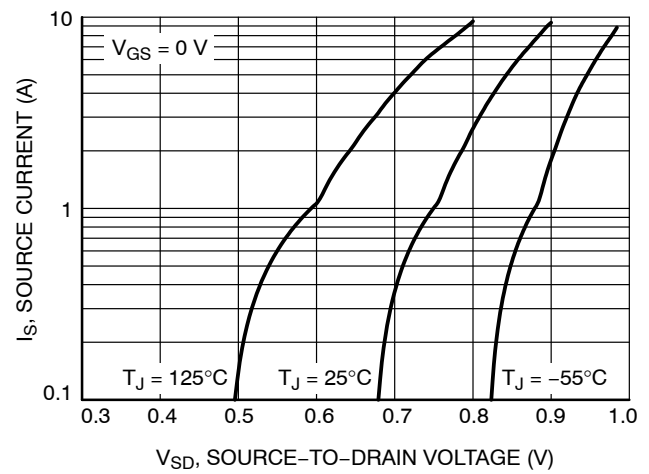

Figure 10. Diode Forward Voltage vs. Current

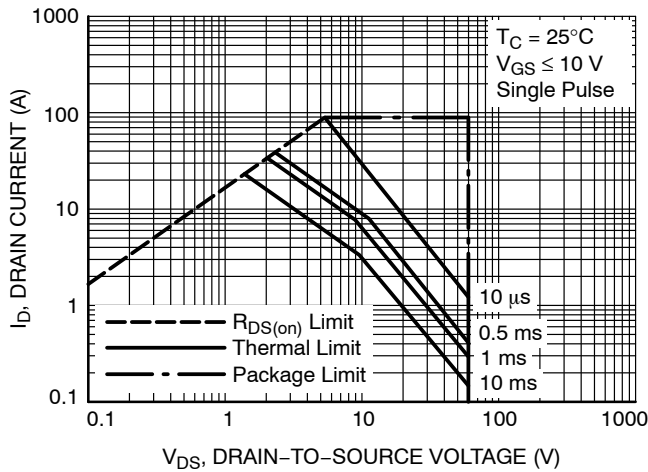

Figure 11. Maximum Rated Forward Biased Safe Operating Area

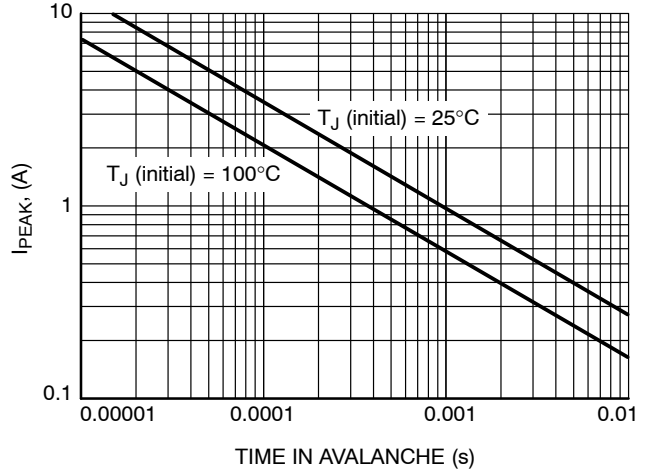

Figure 12.  $I_{PEAK}$  vs. Time in Avalanche

# NVD5C688NL

## TYPICAL CHARACTERISTICS

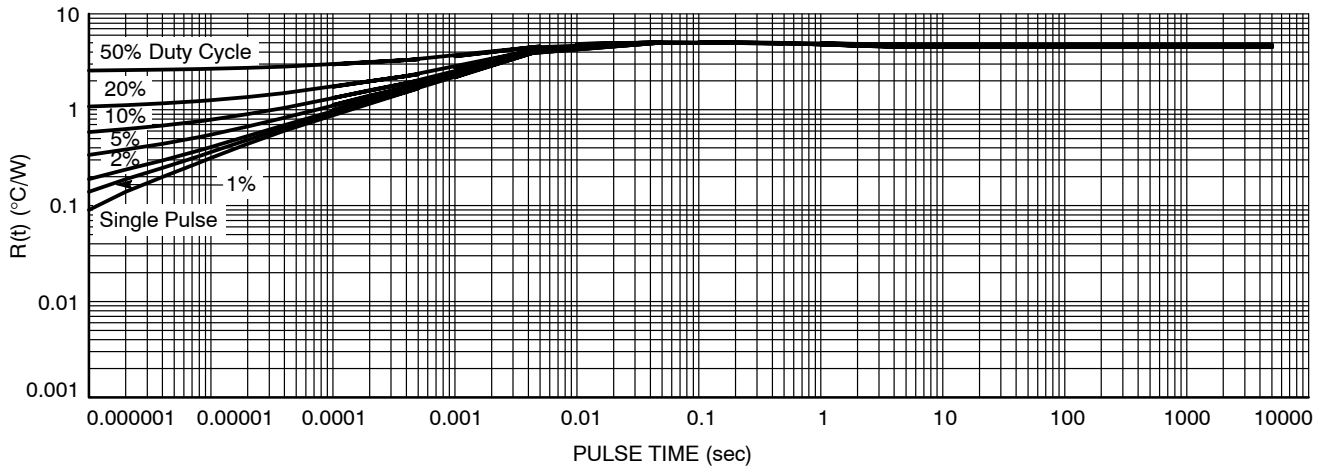

Figure 13. Thermal Response

### ORDERING INFORMATION

Order Number	Package	Shipping <sup>†</sup>
NVD5C688NLT4G	DPAK (Pb-Free)	2500 / Tape & Reel

<sup>†</sup>For information on tape and reel specifications, including part orientation and tape sizes, please refer to our Tape and Reel Packaging Specifications Brochure, BRD8011/D.

# MECHANICAL CASE OUTLINE

## PACKAGE DIMENSIONS

ON Semiconductor®

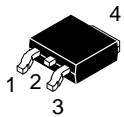

SCALE 1:1

### DPAK (SINGLE GAUGE)

#### CASE 369C

#### ISSUE F

DATE 21 JUL 2015

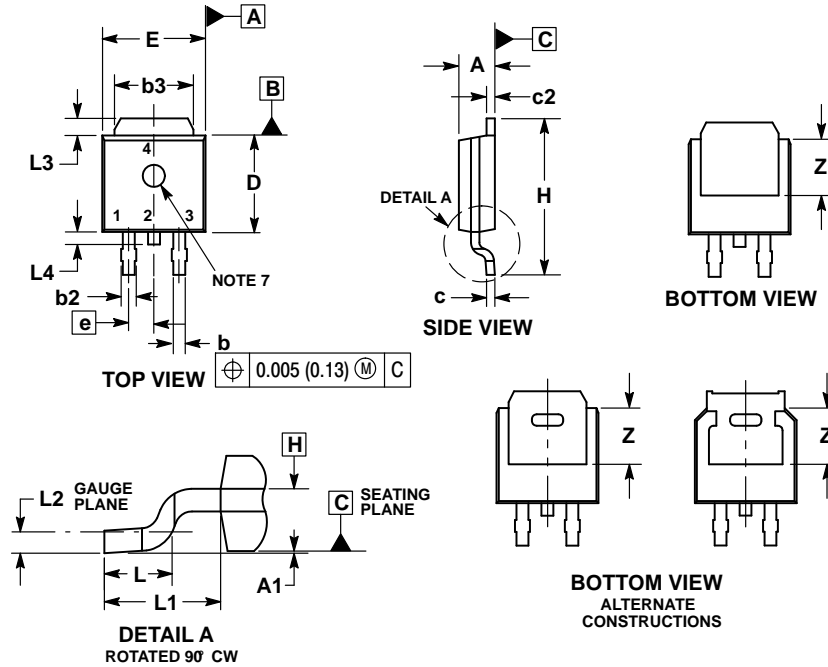

NOTES:

1. DIMENSIONING AND TOLERANCING PER ASME Y14.5M, 1994.
2. CONTROLLING DIMENSION: INCHES.
3. THERMAL PAD CONTOUR OPTIONAL WITHIN DIMENSIONS b3, L3 and Z.
4. DIMENSIONS D AND E DO NOT INCLUDE MOLD FLASH, PROTRUSIONS, OR BURRS. MOLD FLASH, PROTRUSIONS, OR GATE BURRS SHALL NOT EXCEED 0.006 INCHES PER SIDE.
5. DIMENSIONS D AND E ARE DETERMINED AT THE OUTERMOST EXTREMES OF THE PLASTIC BODY.
6. DATUMS A AND B ARE DETERMINED AT DATUM PLANE H.
7. OPTIONAL MOLD FEATURE.

DIM	INCHES		MILLIMETERS	
	MIN	MAX	MIN	MAX
A	0.086	0.094	2.18	2.38
A1	0.000	0.005	0.00	0.13
b	0.025	0.035	0.63	0.89
b2	0.028	0.045	0.72	1.14
b3	0.180	0.215	4.57	5.46
c	0.018	0.024	0.46	0.61
c2	0.018	0.024	0.46	0.61
D	0.235	0.245	5.97	6.22
E	0.250	0.265	6.35	6.73
e	0.090 BSC		2.29 BSC	
H	0.370	0.410	9.40	10.41
L	0.055	0.070	1.40	1.78
L1	0.114 REF		2.90 REF	
L2	0.020 BSC		0.51 BSC	
L3	0.035	0.050	0.89	1.27
L4	---	0.040	---	1.01
Z	0.155	---	3.93	---

### GENERIC MARKING DIAGRAM\*

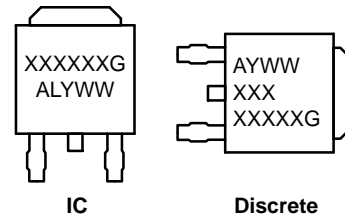

- XXXXXX = Device Code
- A = Assembly Location
- L = Wafer Lot
- Y = Year
- WW = Work Week
- G = Pb-Free Package

\*This information is generic. Please refer to device data sheet for actual part marking.

- |  |  |   |   |  |
|--|--|---|---|--|
| <p>STYLE 1:<br/>PIN 1. BASE<br/>2. COLLECTOR<br/>3. EMITTER<br/>4. COLLECTOR</p> | <p>STYLE 2:<br/>PIN 1. GATE<br/>2. DRAIN<br/>3. SOURCE<br/>4. DRAIN</p>          | <p>STYLE 3:<br/>PIN 1. ANODE<br/>2. CATHODE<br/>3. ANODE<br/>4. CATHODE</p> | <p>STYLE 4:<br/>PIN 1. CATHODE<br/>2. ANODE<br/>3. GATE<br/>4. ANODE</p>              | <p>STYLE 5:<br/>PIN 1. GATE<br/>2. ANODE<br/>3. CATHODE<br/>4. ANODE</p>     |
| <p>STYLE 6:<br/>PIN 1. MT1<br/>2. MT2<br/>3. GATE<br/>4. MT2</p>                 | <p>STYLE 7:<br/>PIN 1. GATE<br/>2. COLLECTOR<br/>3. EMITTER<br/>4. COLLECTOR</p> | <p>STYLE 8:<br/>PIN 1. N/C<br/>2. CATHODE<br/>3. ANODE<br/>4. CATHODE</p>   | <p>STYLE 9:<br/>PIN 1. ANODE<br/>2. CATHODE<br/>3. RESISTOR ADJUST<br/>4. CATHODE</p> | <p>STYLE 10:<br/>PIN 1. CATHODE<br/>2. ANODE<br/>3. CATHODE<br/>4. ANODE</p> |

### SOLDERING FOOTPRINT\*

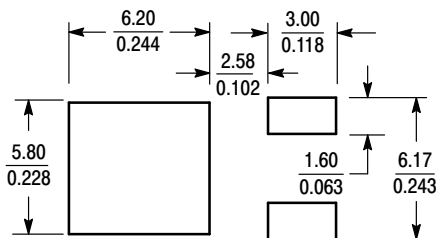

SCALE 3:1 (mm / inches)

\*For additional information on our Pb-Free strategy and soldering details, please download the ON Semiconductor Soldering and Mounting Techniques Reference Manual, SOLDERRM/D.

<b>DOCUMENT NUMBER:</b>	<b>98AON10527D</b>	Electronic versions are uncontrolled except when accessed directly from the Document Repository. Printed versions are uncontrolled except when stamped "CONTROLLED COPY" in red.
<b>STATUS:</b>	<b>ON SEMICONDUCTOR STANDARD</b>	
<b>NEW STANDARD:</b>	<b>REF TO JEDEC TO-252</b>	
<b>DESCRIPTION:</b>	<b>DPAK SINGLE GAUGE SURFACE MOUNT</b>	<b>PAGE 1 OF 2</b>



ISSUE	REVISION	DATE
O	RELEASED FOR PRODUCTION. REQ. BY L. GAN	24 SEP 2001
A	ADDED STYLE 8. REQ. BY S. ALLEN.	06 AUG 2008
B	ADDED STYLE 9. REQ. BY D. WARNER.	16 JAN 2009
C	ADDED STYLE 10. REQ. BY S. ALLEN.	09 JUN 2009
D	RELABELED DRAWING TO JEDEC STANDARDS. ADDED SIDE VIEW DETAIL A. CORRECTED MARKING INFORMATION. REQ. BY D. TRUHITE.	29 JUN 2010
E	ADDED ALTERNATE CONSTRUCTION BOTTOM VIEW. MODIFIED DIMENSIONS b2 AND L1. CORRECTED MARKING DIAGRAM FOR DISCRETE. REQ. BY I. CAMBALIZA.	06 FEB 2014
F	ADDED SECOND ALTERNATE CONSTRUCTION BOTTOM VIEW. REQ. BY K. MUSTAFA.	21 JUL 2015

ON Semiconductor and  are registered trademarks of Semiconductor Components Industries, LLC (SCILLC). SCILLC reserves the right to make changes without further notice to any products herein. SCILLC makes no warranty, representation or guarantee regarding the suitability of its products for any particular purpose, nor does SCILLC assume any liability arising out of the application or use of any product or circuit, and specifically disclaims any and all liability, including without limitation special, consequential or incidental damages. "Typical" parameters which may be provided in SCILLC data sheets and/or specifications can and do vary in different applications and actual performance may vary over time. All operating parameters, including "Typicals" must be validated for each customer application by customer's technical experts. SCILLC does not convey any license under its patent rights nor the rights of others. SCILLC products are not designed, intended, or authorized for use as components in systems intended for surgical implant into the body, or other applications intended to support or sustain life, or for any other application in which the failure of the SCILLC product could create a situation where personal injury or death may occur. Should Buyer purchase or use SCILLC products for any such unintended or unauthorized application, Buyer shall indemnify and hold SCILLC and its officers, employees, subsidiaries, affiliates, and distributors harmless against all claims, costs, damages, and expenses, and reasonable attorney fees arising out of, directly or indirectly, any claim of personal injury or death associated with such unintended or unauthorized use, even if such claim alleges that SCILLC was negligent regarding the design or manufacture of the part. SCILLC is an Equal Opportunity/Affirmative Action Employer. This literature is subject to all applicable copyright laws and is not for resale in any manner.

ON Semiconductor and  are trademarks of Semiconductor Components Industries, LLC dba ON Semiconductor or its subsidiaries in the United States and/or other countries. ON Semiconductor owns the rights to a number of patents, trademarks, copyrights, trade secrets, and other intellectual property. A listing of ON Semiconductor's product/patent coverage may be accessed at [www.onsemi.com/site/pdf/Patent-Marking.pdf](http://www.onsemi.com/site/pdf/Patent-Marking.pdf). ON Semiconductor reserves the right to make changes without further notice to any products herein. ON Semiconductor makes no warranty, representation or guarantee regarding the suitability of its products for any particular purpose, nor does ON Semiconductor assume any liability arising out of the application or use of any product or circuit, and specifically disclaims any and all liability, including without limitation special, consequential or incidental damages. Buyer is responsible for its products and applications using ON Semiconductor products, including compliance with all laws, regulations and safety requirements or standards, regardless of any support or applications information provided by ON Semiconductor. "Typical" parameters which may be provided in ON Semiconductor data sheets and/or specifications can and do vary in different applications and actual performance may vary over time. All operating parameters, including "Typicals" must be validated for each customer application by customer's technical experts. ON Semiconductor does not convey any license under its patent rights nor the rights of others. ON Semiconductor products are not designed, intended, or authorized for use as a critical component in life support systems or any FDA Class 3 medical devices or medical devices with a same or similar classification in a foreign jurisdiction or any devices intended for implantation in the human body. Should Buyer purchase or use ON Semiconductor products for any such unintended or unauthorized application, Buyer shall indemnify and hold ON Semiconductor and its officers, employees, subsidiaries, affiliates, and distributors harmless against all claims, costs, damages, and expenses, and reasonable attorney fees arising out of, directly or indirectly, any claim of personal injury or death associated with such unintended or unauthorized use, even if such claim alleges that ON Semiconductor was negligent regarding the design or manufacture of the part. ON Semiconductor is an Equal Opportunity/Affirmative Action Employer. This literature is subject to all applicable copyright laws and is not for resale in any manner.

## PUBLICATION ORDERING INFORMATION

### LITERATURE FULFILLMENT:

Literature Distribution Center for ON Semiconductor  
19521 E. 32nd Pkwy, Aurora, Colorado 80011 USA  
**Phone:** 303-675-2175 or 800-344-3860 Toll Free USA/Canada  
**Fax:** 303-675-2176 or 800-344-3867 Toll Free USA/Canada  
**Email:** [orderlit@onsemi.com](mailto:orderlit@onsemi.com)

**N. American Technical Support:** 800-282-9855 Toll Free  
USA/Canada  
**Europe, Middle East and Africa Technical Support:**  
Phone: 421 33 790 2910

**ON Semiconductor Website:** [www.onsemi.com](http://www.onsemi.com)

**Order Literature:** <http://www.onsemi.com/orderlit>

For additional information, please contact your local  
Sales Representative