

# NVHL082N65S3F

## MOSFET – Power, N-Channel, SUPERFET® III, FRFET®

**650 V, 40 A, 82 mΩ**

### Description

SUPERFET III MOSFET is ON Semiconductor's brand-new high voltage super-junction (SJ) MOSFET family that is utilizing charge balance technology for outstanding low on-resistance and lower gate charge performance. This advanced technology is tailored to minimize conduction loss, provide superior switching performance, and withstand extreme dv/dt rate.

Consequently, SUPERFET III MOSFET is very suitable for the various power system for miniaturization and higher efficiency.

SUPERFET III FRFET MOSFET's optimized reverse recovery performance of body diode can remove additional component and improve system reliability.

### Features

- 700 V @  $T_J = 150^\circ\text{C}$
- Typ.  $R_{DS(on)} = 64\text{ m}\Omega$
- Ultra Low Gate Charge (Typ.  $Q_g = 81\text{ nC}$ )
- Low Effective Output Capacitance (Typ.  $C_{oss(eff.)} = 722\text{ pF}$ )
- 100% Avalanche Tested
- AEC-Q101 Qualified and PPAP Capable

### Applications

- Automotive On Board Charger HEV-EV
- Automotive DC/DC converter for HEV-EV



**ON Semiconductor®**

[www.onsemi.com](http://www.onsemi.com)

| $V_{DSS}$ | $R_{DS(on)}\text{ MAX}$ | $I_D\text{ MAX}$ |
|-----------|-------------------------|------------------|
| 650 V     | 82 mΩ @ 10 V            | 40 A             |

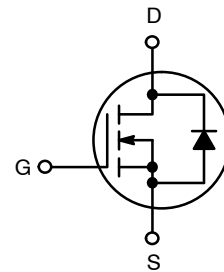

**POWER MOSFET**

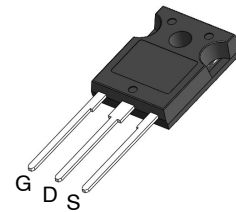

**TO-247 LONG LEADS  
CASE 340CX**

### MARKING DIAGRAM



\$Y = ON Semiconductor Logo  
&Z = Assembly Plant Code  
&3 = Data Code (Year & Week)  
&K = Lot  
NVHL082N65S3F = Specific Device Code

### ORDERING INFORMATION

See detailed ordering and shipping information on page 2 of this data sheet.

# NVHL082N65S3F

## ABSOLUTE MAXIMUM RATINGS (T<sub>C</sub> = 25°C, Unless otherwise noted)

| Symbol                            | Parameter  | Value                                 | Unit |
|-----------------------------------|--|---------------------------------------|------|
| V <sub>DSS</sub>                  | Drain to Source Voltage  | 650                                   | V    |
| V <sub>GSS</sub>                  | Gate to Source Voltage   | - DC                                  | ±30  |
|                                   |  | - AC (f > 1 Hz)                       | ±30  |
| I <sub>D</sub>                    | Drain Current  | - Continuous (T <sub>C</sub> = 25°C)  | 40   |
|                                   |  | - Continuous (T <sub>C</sub> = 100°C) | 25.5 |
| I <sub>DM</sub>                   | Drain Current  | - Pulsed (Note 1)                     | 100  |
| E <sub>AS</sub>                   | Single Pulsed Avalanche Energy (Note 2)                              | 510                                   | mJ   |
| E <sub>AR</sub>                   | Repetitive Avalanche Energy (Note 1)                                 | 3.13                                  | mJ   |
| dv/dt                             | MOSFET dv/dt   | 100                                   | V/ns |
|                                   | Peak Diode Recovery dv/dt (Note 3)                                   | 50                                    |      |
| P <sub>D</sub>                    | Power Dissipation  | (T <sub>C</sub> = 25°C)               | 313  |
|                                   |  | - Derate Above 25°C                   | 2.5  |
| T <sub>J</sub> , T <sub>STG</sub> | Operating and Storage Temperature Range                              | -55 to +150                           | °C   |
| T <sub>L</sub>                    | Maximum Lead Temperature for Soldering, 1/8" from Case for 5 seconds | 300                                   | °C   |

Stresses exceeding those listed in the Maximum Ratings table may damage the device. If any of these limits are exceeded, device functionality should not be assumed, damage may occur and reliability may be affected.

1. Repetitive rating; pulse-width limited by maximum junction temperature.
2. I<sub>AS</sub> = 4.8 A, R<sub>G</sub> = 25 Ω, starting T<sub>J</sub> = 25°C.
3. I<sub>SD</sub> ≤ 20 A, di/dt ≤ 200 A/μs, V<sub>DD</sub> ≤ 400 V, starting T<sub>J</sub> = 25°C.

## THERMAL CHARACTERISTICS

| Symbol           | Parameter                                     | Value | Unit |
|------------------|---|-------|------|
| R <sub>θJC</sub> | Thermal Resistance, Junction to Case, Max.    | 0.4   | °C/W |
| R <sub>θJA</sub> | Thermal Resistance, Junction to Ambient, Max. | 40    |      |

## PACKAGE MARKING AND ORDERING INFORMATION

| Part Number   | Top Marking   | Package | Packing Method | Reel Size | Tape Width | Quantity |
|---------------|---------------|---------|----------------|-----------|------------|----------|
| NVHL082N65S3F | NVHL082N65S3F | TO-247  | Tube           | N/A       | N/A        | 30 Units |

# NVHL082N65S3F

## ELECTRICAL CHARACTERISTICS ( $T_C = 25^\circ\text{C}$ unless otherwise noted)

| Symbol | Parameter | Test Conditions | Min. | Typ. | Max. | Unit |
|--------|-----------|-----------------|------|------|------|------|
|--------|-----------|-----------------|------|------|------|------|

### OFF CHARACTERISTICS

|                                      |   |   |     |     |      |      |
|--------------------------------------|---|---|-----|-----|------|------|
| BV <sub>DSS</sub>                    | Drain to Source Breakdown Voltage         | V <sub>GS</sub> = 0 V, I <sub>D</sub> = 1 mA, T <sub>J</sub> = 25°C   | 650 | –   | –    | V    |
|                                      |   | V <sub>GS</sub> = 0 V, I <sub>D</sub> = 10 mA, T <sub>J</sub> = 150°C | 700 | –   | –    | V    |
| ΔBV <sub>DSS</sub> / ΔT <sub>J</sub> | Breakdown Voltage Temperature Coefficient | I <sub>D</sub> = 20 mA, Referenced to 25°C                            | –   | 0.7 | –    | V/°C |
| I <sub>DSS</sub>                     | Zero Gate Voltage Drain Current           | V <sub>DS</sub> = 650 V, V <sub>GS</sub> = 0 V                        | –   | –   | 10   | μA   |
|                                      |   | V <sub>DS</sub> = 520 V, T <sub>C</sub> = 125°C                       | –   | 127 | –    |      |
| I <sub>GSS</sub>                     | Gate to Body Leakage Current              | V <sub>GS</sub> = ±30 V, V <sub>DS</sub> = 0 V                        | –   | –   | ±100 | nA   |

### ON CHARACTERISTICS

|                     |                                      |   |     |    |     |    |
|---------------------|--------------------------------------|---|-----|----|-----|----|
| V <sub>GS(th)</sub> | Gate Threshold Voltage               | V <sub>GS</sub> = V <sub>DS</sub> , I <sub>D</sub> = 4 mA | 3.0 | –  | 5.0 | V  |
| R <sub>DS(on)</sub> | Static Drain to Source On Resistance | V <sub>GS</sub> = 10 V, I <sub>D</sub> = 20 A             | –   | 64 | 82  | mΩ |
| g <sub>FS</sub>     | Forward Transconductance             | V <sub>DS</sub> = 20 V, I <sub>D</sub> = 20 A             | –   | 24 | –   | S  |

### DYNAMIC CHARACTERISTICS

|                        |                                   |  |   |      |   |    |
|------------------------|-----------------------------------|--|---|------|---|----|
| C <sub>iss</sub>       | Input Capacitance                 | V <sub>DS</sub> = 400 V, V <sub>GS</sub> = 0 V, f = 1 MHz                          | – | 3410 | – | pF |
| C <sub>oss</sub>       | Output Capacitance                |  | – | 70   | – | pF |
| C <sub>oss(eff.)</sub> | Effective Output Capacitance      | V <sub>DS</sub> = 0 V to 400 V, V <sub>GS</sub> = 0 V                              | – | 722  | – | pF |
| C <sub>oss(er.)</sub>  | Energy Related Output Capacitance | V <sub>DS</sub> = 0 V to 400 V, V <sub>GS</sub> = 0 V                              | – | 126  | – | pF |
| Q <sub>g(tot)</sub>    | Total Gate Charge at 10 V         | V <sub>DS</sub> = 400 V, I <sub>D</sub> = 20 A, V <sub>GS</sub> = 10 V<br>(Note 4) | – | 81   | – | nC |
| Q <sub>gs</sub>        | Gate to Source Gate Charge        |  | – | 24   | – | nC |
| Q <sub>gd</sub>        | Gate to Drain "Miller" Charge     |  | – | 32   | – | nC |
| ESR                    | Equivalent Series Resistance      | f = 1 MHz  | – | 1.9  | – | Ω  |

### SWITCHING CHARACTERISTICS

|                     |                     |   |   |    |   |    |
|---------------------|---------------------|---|---|----|---|----|
| t <sub>d(on)</sub>  | Turn-On Delay Time  | V <sub>DD</sub> = 400 V, I <sub>D</sub> = 20 A,<br>V <sub>GS</sub> = 10 V, R <sub>g</sub> = 4.7 Ω<br>(Note 4) | – | 31 | – | ns |
| t <sub>r</sub>      | Turn-On Rise Time   |   | – | 29 | – | ns |
| t <sub>d(off)</sub> | Turn-Off Delay Time |   | – | 76 | – | ns |
| t <sub>f</sub>      | Turn-Off Fall Time  |   | – | 16 | – | ns |

### SOURCE-DRAIN DIODE CHARACTERISTICS

|                 |  |  |   |     |     |    |
|-----------------|--|--|---|-----|-----|----|
| I <sub>S</sub>  | Maximum Continuous Source to Drain Diode Forward Current | –  | – | 40  | A   |    |
| I <sub>SM</sub> | Maximum Pulsed Source to Drain Diode Forward Current     | –  | – | 100 | A   |    |
| V <sub>SD</sub> | Source to Drain Diode Forward Voltage                    | V <sub>GS</sub> = 0 V, I <sub>SD</sub> = 20 A                                    | – | –   | 1.3 | V  |
| t <sub>rr</sub> | Reverse Recovery Time                                    | V <sub>GS</sub> = 0 V, I <sub>SD</sub> = 20 A,<br>dI <sub>F</sub> /dt = 100 A/μs | – | 108 | –   | ns |
| Q <sub>rr</sub> | Reverse Recovery Charge                                  |  | – | 410 | –   | nC |

Product parametric performance is indicated in the Electrical Characteristics for the listed test conditions, unless otherwise noted. Product performance may not be indicated by the Electrical Characteristics if operated under different conditions.

4. Essentially independent of operating temperature typical characteristics.

# NVHL082N65S3F

## TYPICAL CHARACTERISTICS

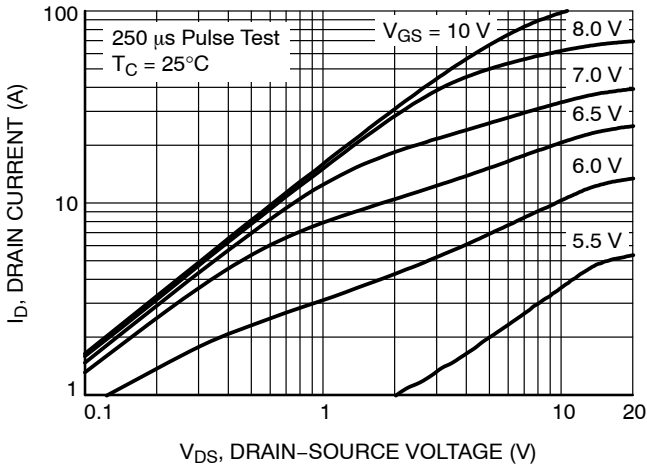

**Figure 1. On-Region Characteristics  
25°C**

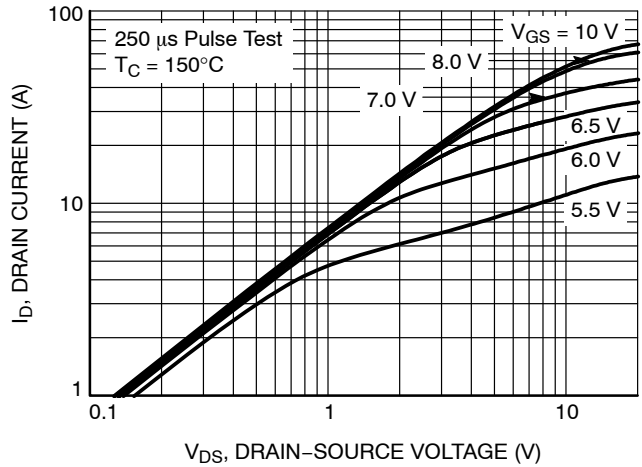

**Figure 2. On-Region Characteristics  
150°C**

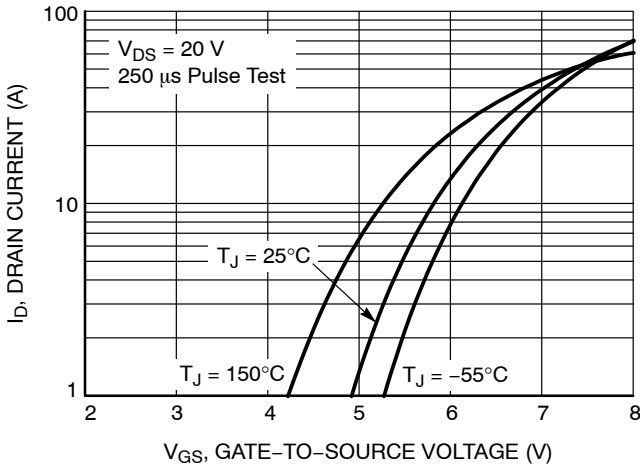

**Figure 3. Transfer Characteristics**

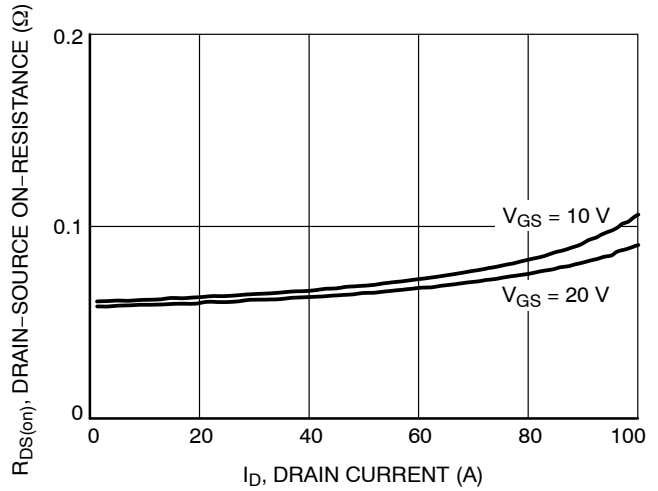

**Figure 4. On-Resistance Variation vs. Drain  
Current and Gate Voltage**

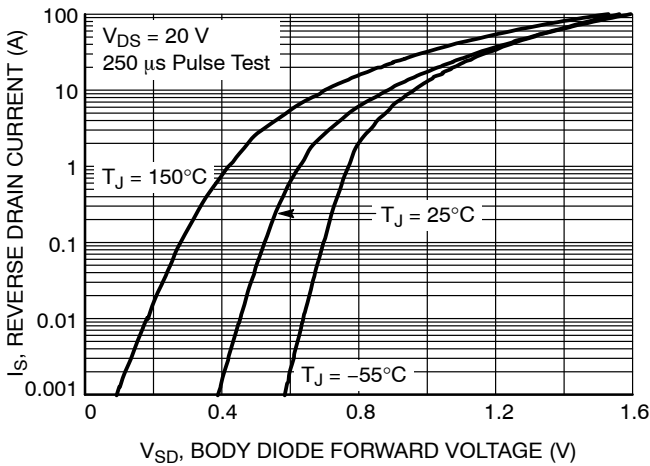

**Figure 5. Body Diode Forward Voltage  
Variation vs. Source Current and Temperature**

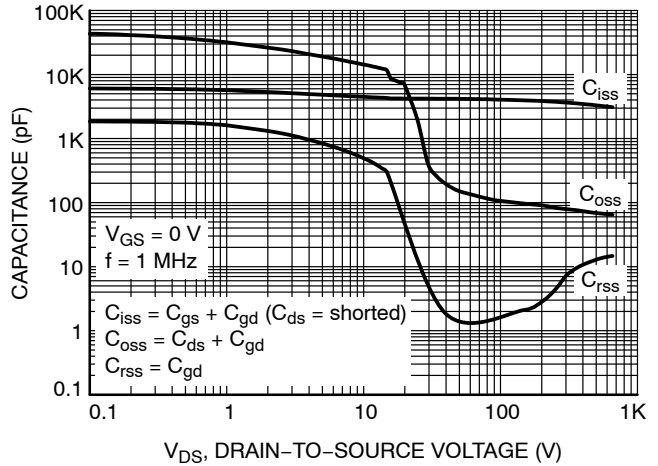

**Figure 6. Capacitance Characteristics**

TYPICAL CHARACTERISTICS

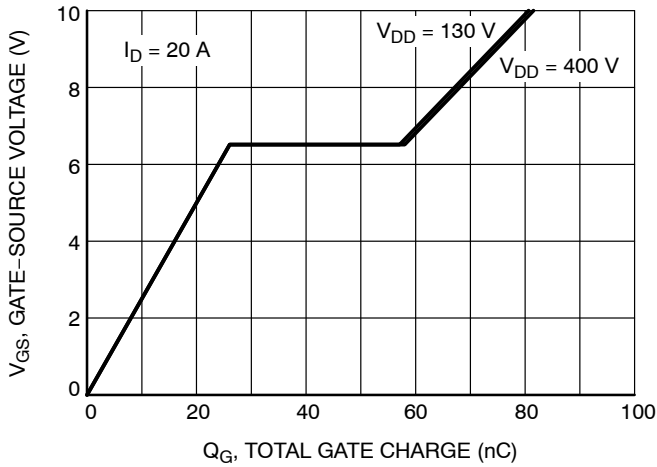

Figure 7. Gate Charge Characteristics

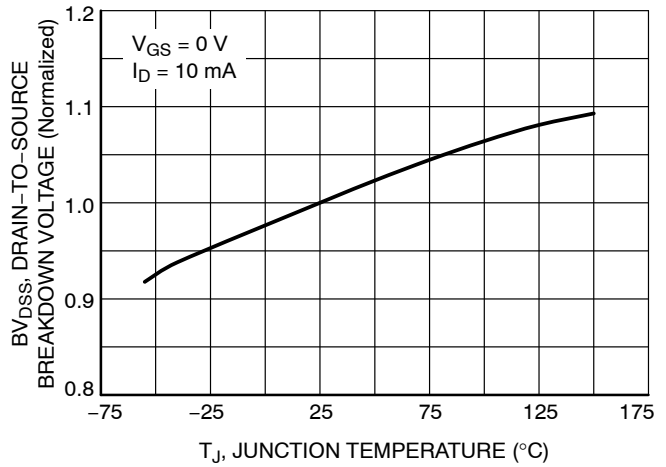

Figure 8. Breakdown Voltage Variation vs. Temperature

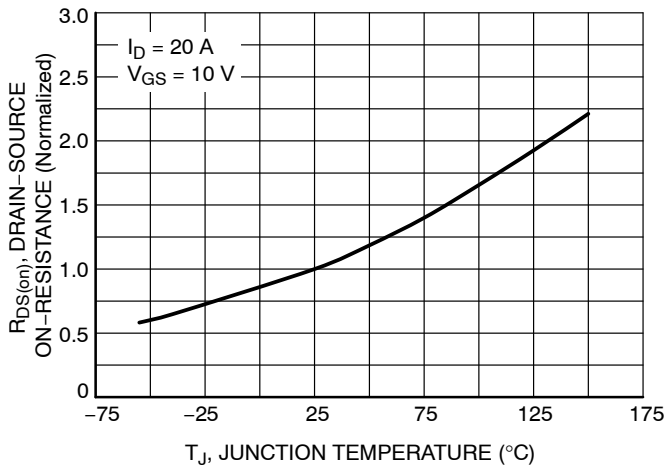

Figure 9. On-Resistance Variation vs. Temperature

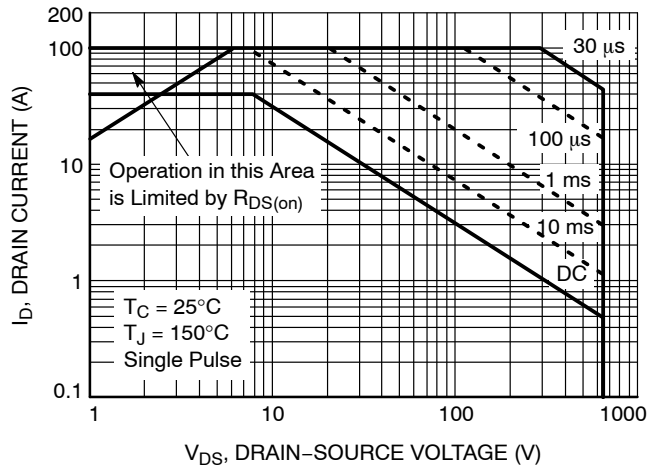

Figure 10. Maximum Safe Operating Area

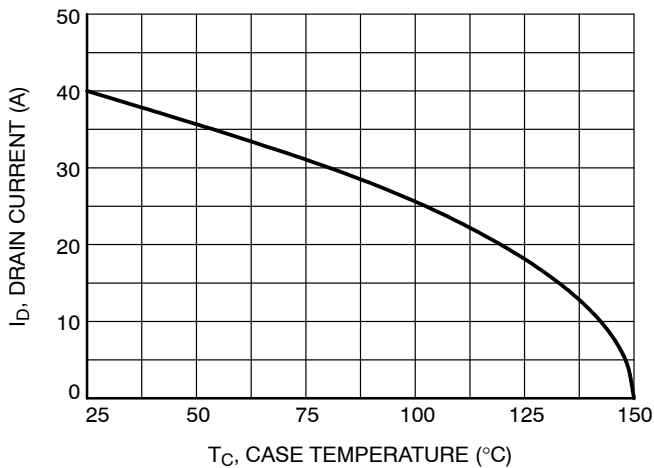

Figure 11. Maximum Drain Current vs. Case Temperature

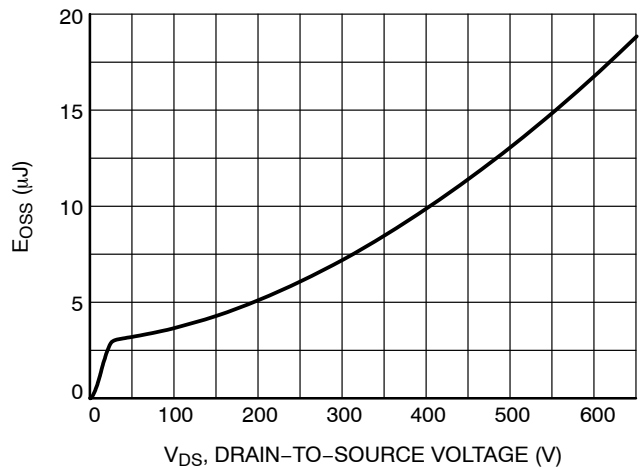

Figure 12.  $E_{OSS}$  vs. Drain-to-Source Voltage

# NVHL082N65S3F

## TYPICAL CHARACTERISTICS

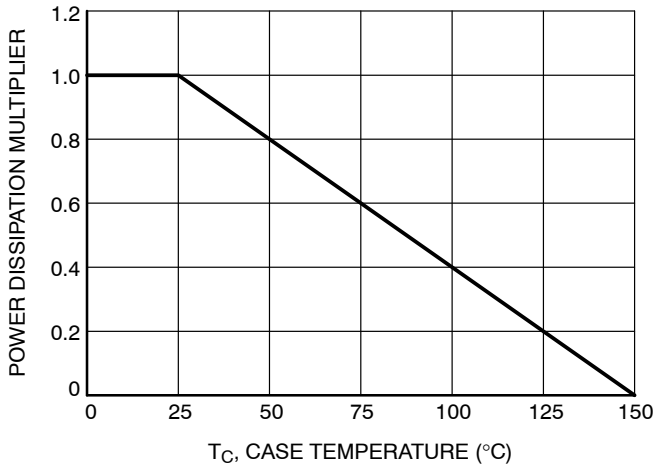

Figure 13. Normalized Power Dissipation vs. Case Temperature

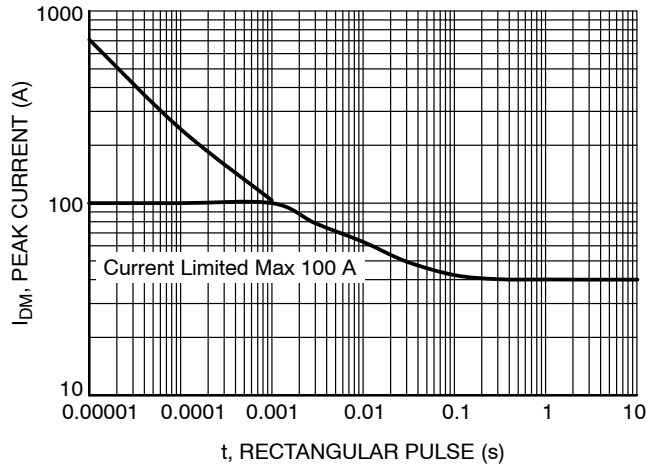

Figure 14. Peak Current Capability

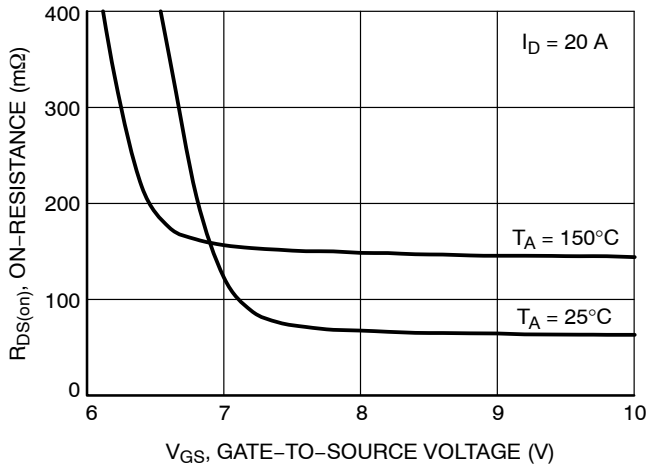

Figure 15. R<sub>DS(on)</sub> vs. Gate Voltage

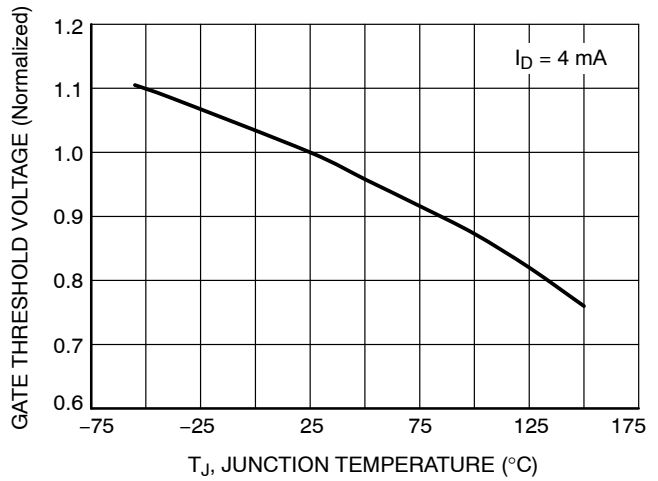

Figure 16. Normalized Gate Threshold Voltage vs. Temperature

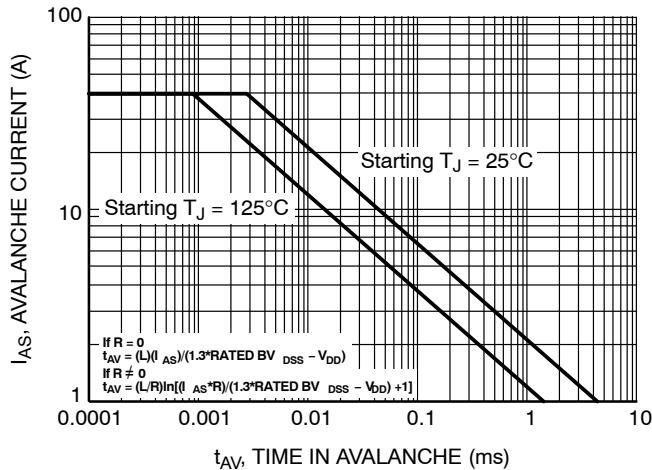

Figure 17. Unclamped Inductive Switching Capability

# NVHL082N65S3F

## TYPICAL CHARACTERISTICS

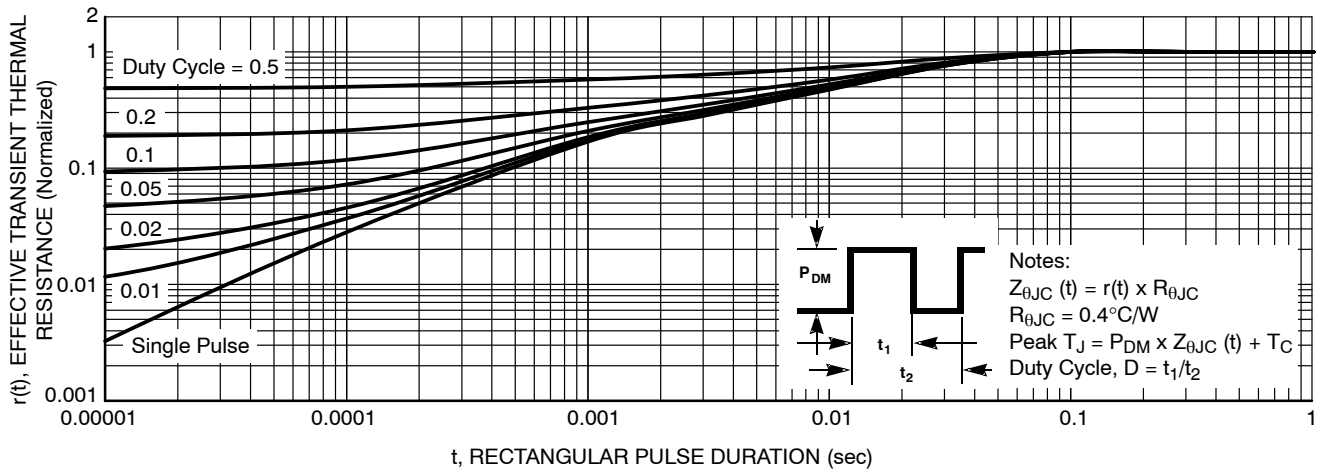

Figure 18. Transient Thermal Response

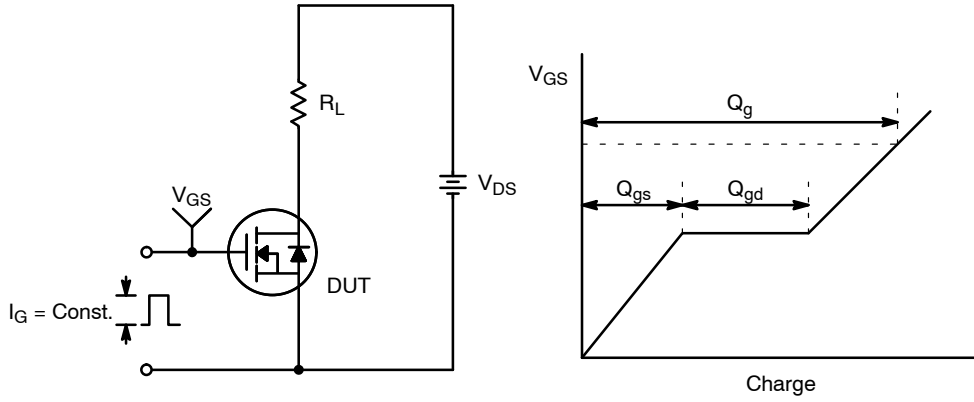

Figure 19. Gate Charge Test Circuit & Waveform

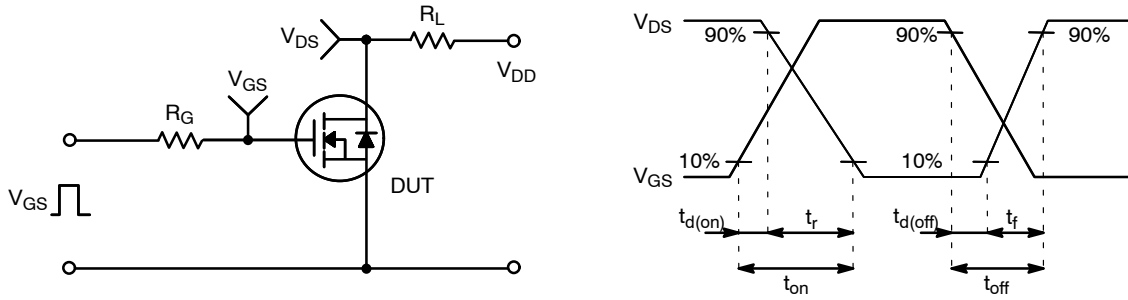

Figure 20. Resistive Switching Test Circuit & Waveforms

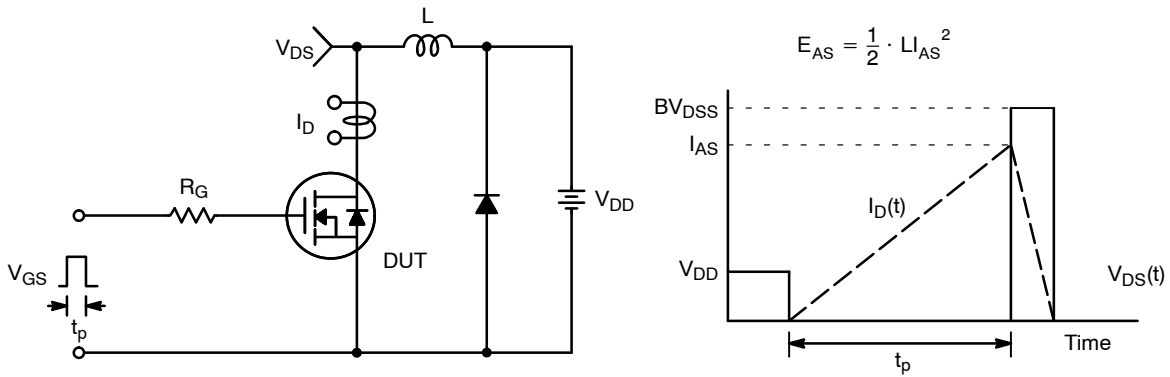
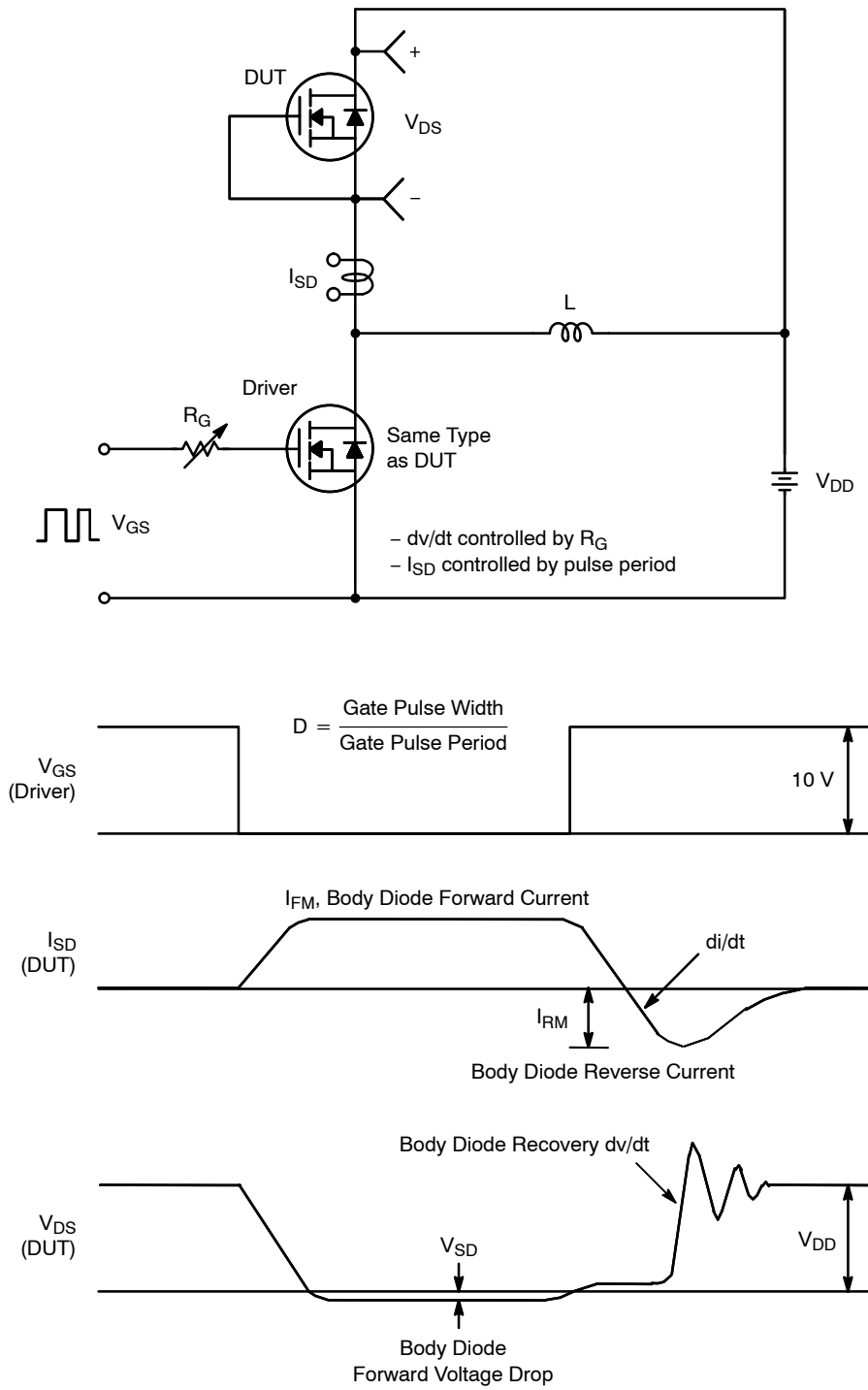

Figure 21. Unclamped Inductive Switching Test Circuit & Waveforms



# NVHL082N65S3F



**Figure 22. Peak Diode Recovery  $dv/dt$  Test Circuit & Waveforms**



SUPERFET and FRFET are a registered trademarks of Semiconductor Components Industries, LLC (SCILLC) or its subsidiaries in the United States and/or other countries.

ON Semiconductor and  are trademarks of Semiconductor Components Industries, LLC dba ON Semiconductor or its subsidiaries in the United States and/or other countries. ON Semiconductor owns the rights to a number of patents, trademarks, copyrights, trade secrets, and other intellectual property. A listing of ON Semiconductor's product/patent coverage may be accessed at [www.onsemi.com/site/pdf/Patent-Marking.pdf](http://www.onsemi.com/site/pdf/Patent-Marking.pdf). ON Semiconductor reserves the right to make changes without further notice to any products herein. ON Semiconductor makes no warranty, representation or guarantee regarding the suitability of its products for any particular purpose, nor does ON Semiconductor assume any liability arising out of the application or use of any product or circuit, and specifically disclaims any and all liability, including without limitation special, consequential or incidental damages. Buyer is responsible for its products and applications using ON Semiconductor products, including compliance with all laws, regulations and safety requirements or standards, regardless of any support or applications information provided by ON Semiconductor. "Typical" parameters which may be provided in ON Semiconductor data sheets and/or specifications can and do vary in different applications and actual performance may vary over time. All operating parameters, including "Typicals" must be validated for each customer application by customer's technical experts. ON Semiconductor does not convey any license under its patent rights nor the rights of others. ON Semiconductor products are not designed, intended, or authorized for use as a critical component in life support systems or any FDA Class 3 medical devices or medical devices with a same or similar classification in a foreign jurisdiction or any devices intended for implantation in the human body. Should Buyer purchase or use ON Semiconductor products for any such unintended or unauthorized application, Buyer shall indemnify and hold ON Semiconductor and its officers, employees, subsidiaries, affiliates, and distributors harmless against all claims, costs, damages, and expenses, and reasonable attorney fees arising out of, directly or indirectly, any claim of personal injury or death associated with such unintended or unauthorized use, even if such claim alleges that ON Semiconductor was negligent regarding the design or manufacture of the part. ON Semiconductor is an Equal Opportunity/Affirmative Action Employer. This literature is subject to all applicable copyright laws and is not for resale in any manner.

**PUBLICATION ORDERING INFORMATION**

**LITERATURE FULFILLMENT:**

Literature Distribution Center for ON Semiconductor  
19521 E. 32nd Pkwy, Aurora, Colorado 80011 USA  
**Phone:** 303-675-2175 or 800-344-3860 Toll Free USA/Canada  
**Fax:** 303-675-2176 or 800-344-3867 Toll Free USA/Canada  
**Email:** [orderlit@onsemi.com](mailto:orderlit@onsemi.com)

**N. American Technical Support:** 800-282-9855 Toll Free  
USA/Canada  
**Europe, Middle East and Africa Technical Support:**  
Phone: 421 33 790 2910

**ON Semiconductor Website:** [www.onsemi.com](http://www.onsemi.com)  
**Order Literature:** <http://www.onsemi.com/orderlit>

For additional information, please contact your local Sales Representative