

NXH160T120L2Q1PG, NXH160T120L2Q1SG

Q1PACK Module

This high-density, integrated power module combines high-performance IGBTs with rugged anti-parallel diodes.

Features

- Extremely Efficient Trench with Fieldstop Technology
- Low Switching Loss Reduces System Power Dissipation
- Module Design Offers High Power Density
- Low Inductive Layout
- Q1PACK Package with Press-Fit and Solder Pins

Typical Applications

- Solar Inverters
- Uninterruptable Power Supplies

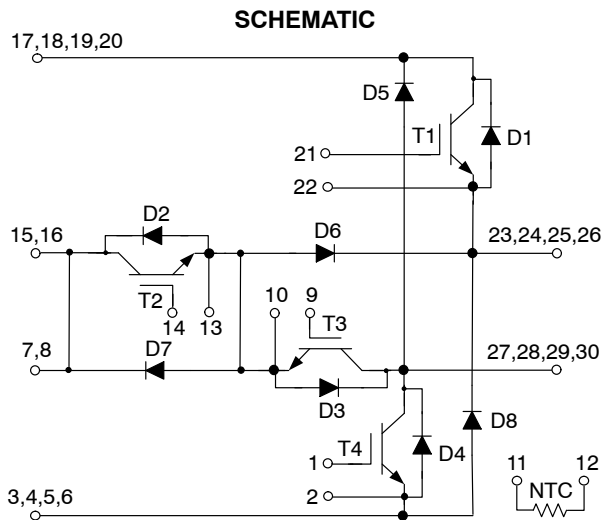

ON Semiconductor®

www.onsemi.com

PACKAGE PICTURE

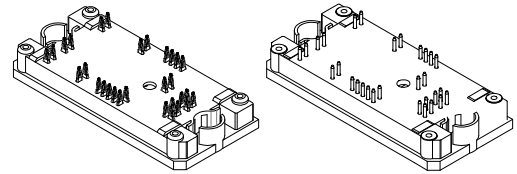

**Q1PACK
CASE 180AD
PRESS FIT**

**Q1PACK
CASE 180AQ
SOLDER PINS**

DEVICE MARKING

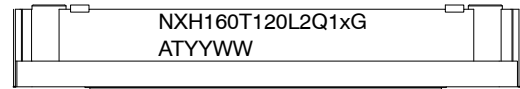

x = P or S
G = Pb-Free Package
AT = Assembly & Test Site Code
YYWW = Year and Work Week Code

PIN ASSIGNMENTS

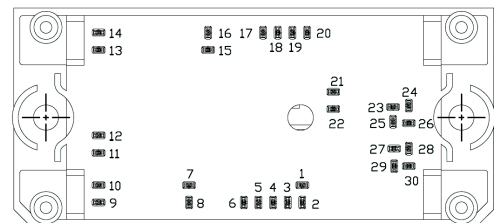

ORDERING INFORMATION

See detailed ordering and shipping information on page 14 of this data sheet.

NXH160T120L2Q1PG, NXH160T120L2Q1SG

Table 1. ABSOLUTE MAXIMUM RATINGS

Rating	Symbol	Value	Unit
HALFBRIDGE IGBT INVERSE DIODE (D1, D4)			
Peak Repetitive Reverse Voltage	V_{RRM}	1200	V
Forward Current, DC @ $T_h = 80^\circ\text{C}$	I_F	20	A
Repetitive Peak Forward Current T_{pulse} limited by $T_{J\text{max}}$	I_{FRM}	80	A
Power Dissipation per Diode $T_j = T_{J\text{max}}$ $T_h = 80^\circ\text{C}$	P_{tot}	51	W
Maximum Junction Temperature	T_J	150	$^\circ\text{C}$
HALFBRIDGE IGBT (T1, T4)			
Collector-emitter voltage	V_{CES}	1200	V
Collector current @ $T_h = 80^\circ\text{C}$	I_C	140	A
Pulsed Collector Current, T_{pulse} Limited by $T_{J\text{max}}$	I_{CM}	480	A
Power Dissipation per IGBT $T_j = T_{J\text{max}}$ $T_h = 80^\circ\text{C}$	P_{tot}	280	W
Gate-emitter voltage	V_{GE}	± 20	V
Short Circuit Withstand Time $V_{GE} = 15\text{ V}$, $V_{CE} = 600\text{ V}$, $T_J \leq 150^\circ\text{C}$	T_{SC}	10	μs
Maximum Junction Temperature	T_J	150	$^\circ\text{C}$
NP DIODE (D6, D7)			
Peak Repetitive Reverse Voltage	V_{RRM}	650	V
Forward Current, DC @ $T_h = 80^\circ\text{C}$	I_F	58	A
Repetitive Peak Forward Current, T_{pulse} limited by $T_{J\text{max}}$	I_{FRM}	200	A
Power Dissipation Per Diode $T_j = T_{J\text{max}}$ $T_h = 80^\circ\text{C}$	P_{tot}	89	W
Maximum Junction Temperature	T_J	150	$^\circ\text{C}$
NP IGBT (T2, T3)			
Collector-emitter voltage	V_{CES}	650	V
Collector current @ $T_h = 80^\circ\text{C}$	I_C	83	A
Pulsed collector current, T_{pulse} limited by $T_{J\text{max}}$	I_{CM}	235	A
Power Dissipation Per IGBT $T_j = T_{J\text{max}}$ $T_h = 80^\circ\text{C}$	P_{tot}	117	W
Gate-emitter voltage	V_{GE}	± 20	V
Short Circuit Withstand Time $V_{GE} = 15\text{ V}$, $V_{CE} = 400\text{ V}$, $T_J \leq 150^\circ\text{C}$	T_{sc}	5	μs
Maximum Junction Temperature	T_J	150	$^\circ\text{C}$
NP INVERSE DIODE (D2, D3)			
Peak Repetitive Reverse Voltage	V_{RRM}	650	V
Forward Current, DC @ $T_h = 80^\circ\text{C}$	I_F	17	A
Repetitive Peak Forward Current, T_{pulse} limited by $T_{J\text{max}}$	I_{FRM}	68	A
Power Dissipation Per Diode $T_j = T_{J\text{max}}$ $T_h = 80^\circ\text{C}$	P_{tot}	28	W
Maximum Junction Temperature	T_J	150	$^\circ\text{C}$
HALFBRIDGE DIODE (D5, D8)			
Peak Repetitive Reverse Voltage	V_{RRM}	1200	V
Forward Current, DC @ $T_h = 80^\circ\text{C}$ (per diode)	I_F	45	A
Repetitive Peak Forward Current, T_{pulse} limited by $T_{J\text{max}}$	I_{FRM}	180	A
Power Dissipation Per Diode $T_j = T_{J\text{max}}$ $T_h = 80^\circ\text{C}$	P_{tot}	78	W

NXH160T120L2Q1PG, NXH160T120L2Q1SG

Table 1. ABSOLUTE MAXIMUM RATINGS

Rating	Symbol	Value	Unit
HALFBRIDGE DIODE (D5, D8)			
Junction Temperature	T_J	150	°C
THERMAL PROPERTIES			
Operating Temperature under switching condition	$T_{VJ\ OP}$	-40 to ($T_{jmax}-25$)	°C
Storage Temperature range	T_{stg}	-40 to 125	°C
INSULATION PROPERTIES			
Isolation test voltage, t = 1 sec, 60 Hz/50 Hz	V_{is}	3000	V_{RMS}
Creepage distance		12.7	mm
Clearance		8.06	mm

Stresses exceeding those listed in the Maximum Ratings table may damage the device. If any of these limits are exceeded, device functionality should not be assumed, damage may occur and reliability may be affected.

Table 2. ELECTRICAL CHARACTERISTICS ($T_J = 25^\circ\text{C}$ unless otherwise specified)

Parameter	Test Conditions	Symbol	Min	Typ	Max	Unit
HALFBRIDGE IGBT INVERSE DIODE (D1, D4) CHARACTERISTICS						
Forward voltage	$I_F = 7\text{ A}$, $T_j = 25^\circ\text{C}$ $I_F = 7\text{ A}$, $T_j = 125^\circ\text{C}$	V_F	-	1.46 1.49	2.7 -	V
Thermal Resistance – chip-to-heatsink	Thermal grease, Thickness = 2 Mil \pm 2%, $\lambda = 1\text{ W/mK}$	R_{thJH}		1.864		°C/W
HALFBRIDGE IGBT (T1, T4) CHARACTERISTICS						
Collector-emitter saturation voltage	$V_{GE} = 15\text{ V}$, $I_C = 160\text{ A}$, $T_j = 25^\circ\text{C}$ $V_{GE} = 15\text{ V}$, $I_C = 160\text{ A}$, $T_j = 125^\circ\text{C}$	$V_{CE(sat)}$	-	2.06 2.10	2.50 -	V
Gate-emitter threshold voltage	$V_{GE} = V_{CE}$, $I_C = 6\text{ mA}$	$V_{GE(TH)}$	5.0	5.80	6.50	V
Collector-emitter cutoff current	$V_{GE} = 0\text{ V}$, $V_{CE} = 1200\text{ V}$	I_{CES}	-	-	800	μA
Gate leakage current	$V_{GE} = 20\text{ V}$, $V_{CE} = 0\text{ V}$	I_{GES}	-	-	800	nA
Turn-on delay time	$T_j = 125^\circ\text{C}$ $V_{CE} = 350\text{ V}$, $I_C = 100\text{ A}$ $V_{GE} = \pm 15\text{ V}$, $R_G = 4\ \Omega$	$t_{d(on)}$	-	55	-	ns
Rise time		t_r	-	50	-	
Turn-off delay time		$t_{d(off)}$	-	430	-	
Fall time		t_f	-	105	-	
Turn on switching loss		E_{on}	-	2.73	-	
Turn off switching loss	E_{off}	-	3.58	-		
Input capacitance	$V_{CE} = 25\text{ V}$, $V_{GE} = 0\text{ V}$, $f = 10\text{ kHz}$	C_{ies}	-	38164	-	pF
Output capacitance		C_{oes}	-	644	-	
Reverse transfer capacitance		C_{res}	-	784	-	
Gate charge total	$V_{CE} = 600\text{ V}$, $I_C = 160\text{ A}$, $V_{GE} = 15\text{ V}$	Q_g	-	1664	-	nC
Thermal Resistance – chip-to-heatsink	Thermal grease, Thickness = 2 Mil \pm 2%, $\lambda = 1\text{ W/mK}$	R_{thJH}		0.337		°C/W
NP DIODE (D6, D7) CHARACTERISTICS						
Forward voltage	$V_{GE} = 0\text{ V}$, $I_F = 150\text{ A}$, $T_j = 25^\circ\text{C}$ $V_{GE} = 0\text{ V}$, $I_F = 150\text{ A}$, $T_j = 125^\circ\text{C}$	V_F	-	2.15 2.36	2.60 -	V
Reverse leakage current	$V_{CE} = 650\text{ V}$, $V_{GE} = 0\text{ V}$	I_r	-	-	200	μA
Reverse recovery time	$T_j = 125^\circ\text{C}$ $V_{CE} = 350\text{ V}$, $I_C = 100\text{ A}$ $V_{GE} = \pm 15\text{ V}$, $R_G = 4\ \Omega$	t_{rr}	-	225	-	ns
Reverse recovery charge		Q_{rr}	-	6.15	-	μC
Peak reverse recovery current		I_{rrm}	-	85	-	A
Peak rate of fall of recovery current		di/dt_{max}	-	1315	-	A/ μs
Reverse recovery energy		E_{rr}	-	1.336	-	mJ
Thermal Resistance – chip-to-heatsink	Thermal grease, Thickness = 2 Mil \pm 2%, $\lambda = 1\text{ W/mK}$	R_{thJH}	-	1.07	-	°C/W

NXH160T120L2Q1PG, NXH160T120L2Q1SG

Table 2. ELECTRICAL CHARACTERISTICS ($T_J = 25^\circ\text{C}$ unless otherwise specified)

Parameter	Test Conditions	Symbol	Min	Typ	Max	Unit
NP IGBT (T2, T3)						
Collector-emitter saturation voltage	$V_{CE} = 15\text{ V}, I_C = 150\text{ A}, T_J = 25^\circ\text{C}$ $V_{CE} = 15\text{ V}, I_C = 150\text{ A}, T_J = 125^\circ\text{C}$	$V_{CE(sat)}$	– –	1.65 1.84	2.0 –	V
Gate-emitter threshold voltage	$V_{GE} = V_{CE}, I_C = 8\text{ mA}$	$V_{GE(TH)}$	5.0	6.10	6.90	V
Collector-emitter cutoff current	$V_{GE} = 0\text{ V}, V_{CE} = 650\text{ V}$	I_{CES}	–	–	400	μA
Gate leakage current	$V_{GE} = 20\text{ V}, V_{CE} = 0\text{ V}$	I_{GES}	–	–	800	nA
Turn-on delay time	$T_J = 125^\circ\text{C}$ $V_{CE} = 350\text{ V}, I_C = 100\text{ A}$ $V_{GE} = \pm 15\text{ V}, R_G = 4\ \Omega$	$t_{d(on)}$	–	46	–	ns
Rise time		t_r	–	48	–	
Turn-off delay time		$t_{d(off)}$	–	250	–	
Fall time		t_f	–	105	–	
Turn on switching loss			E_{on}	–	1.245	–
Turn off switching loss		E_{off}	–	2.525	–	
Input capacitance	$V_{CE} = 25\text{ V}, V_{GE} = 0\text{ V}, f = 10\text{ kHz}$	C_{ies}	–	19380	–	pF
Output capacitance		C_{oes}	–	570	–	
Reverse transfer capacitance		C_{res}	–	496	–	
Gate charge total	$V_{CE} = 480\text{ V}, I_C = 150\text{ A}, V_{GE} = 15\text{ V}$	Q_g	–	790	–	nC
Thermal Resistance – chip-to-heatsink	Thermal grease, Thickness = 2 Mil \pm 2%, $\lambda = 1\text{ W/mK}$	R_{thJH}	–	0.81	–	$^\circ\text{C/W}$
NP INVERSE DIODE (D2, D3)						
Forward voltage	$V_{GE} = 0\text{ V}, I_F = 15\text{ A}, T_J = 25^\circ\text{C}$ $V_{GE} = 0\text{ V}, I_F = 15\text{ A}, T_J = 125^\circ\text{C}$	V_F	– –	1.60 1.59	2.20 –	V
Thermal Resistance – chip-to-heatsink	Thermal grease, Thickness = 2 Mil \pm 2%, $\lambda = 1\text{ W/mK}$	R_{thJH}		3.43		$^\circ\text{C/W}$
HALFBRIDGE DIODE (D5, D8)						
Forward voltage	$V_{GE} = 0\text{ V}, I_F = 150\text{ A}, T_J = 25^\circ\text{C}$ $V_{GE} = 0\text{ V}, I_F = 150\text{ A}, T_J = 125^\circ\text{C}$	V_F	– –	2.50 2.80	3.50 –	V
Reverse leakage current	$V_{CE} = 1200\text{ V}, V_{GE} = 0\text{ V}$	I_r	–	–	200	μA
Reverse recovery time	$T_J = 125^\circ\text{C}$ $V_{CE} = 350\text{ V}, I_C = 100\text{ A}$ $V_{GE} = \pm 15\text{ V}, R_G = 4\ \Omega$	t_{rr}	–	405	–	ns
Reverse recovery charge		Q_{rr}	–	15.5	–	μC
Peak reverse recovery current		I_{rrm}	–	220	–	A
Peak rate of fall of recovery current		di/dt_{max}	–	5440	–	$\text{A}/\mu\text{s}$
Reverse recovery energy		E_{rr}	–	5.225	–	mJ
Thermal Resistance – chip-to-heatsink	Thermal grease, Thickness = 2 Mil \pm 2%, $\lambda = 1\text{ W/mK}$	R_{thJH}	–	1.213	–	$^\circ\text{C/W}$
THERMISTOR CHARACTERISTICS						
Nominal resistance		R_{25}	–	22	–	$\text{k}\Omega$
Nominal resistance	$T = 100^\circ\text{C}$	R_{100}	–	1486	–	Ω
Deviation of R25		DR/R	–5	–	5	%
Power dissipation		P_D	–	200	–	mW
Power dissipation constant			–	2	–	mW/K
B-value	B(25/50), tol \pm 3%		–	3950	–	K
B-value	B(25/100), tol \pm 3%		–	3998	–	K

NXH160T120L2Q1PG, NXH160T120L2Q1SG

TYPICAL CHARACTERISTICS – HALF BRIDGE IGBT AND NEUTRAL POINT FORWARD DIODE

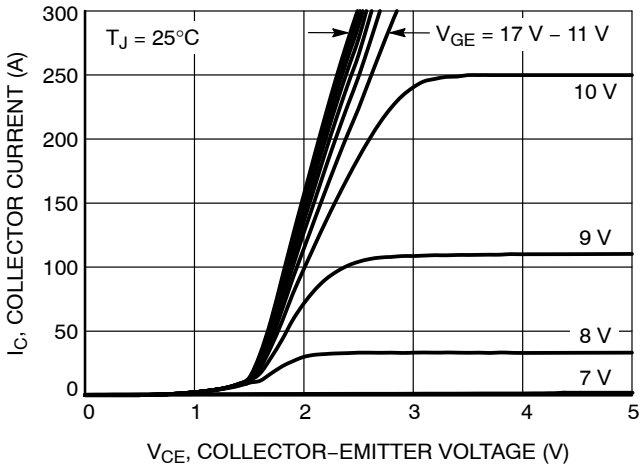

Figure 1. Typical Output Characteristics

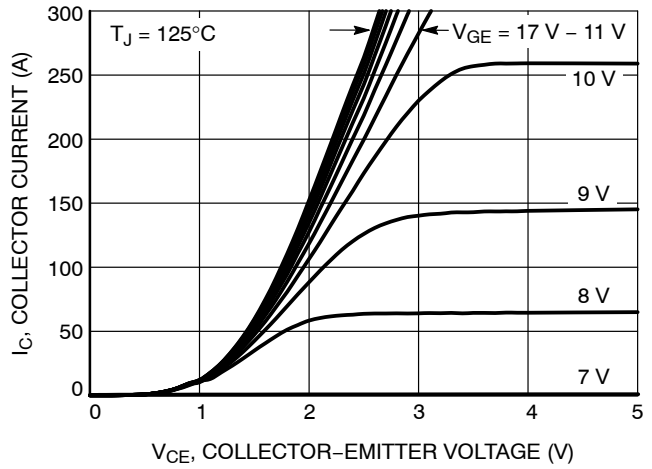

Figure 2. Typical Output Characteristics

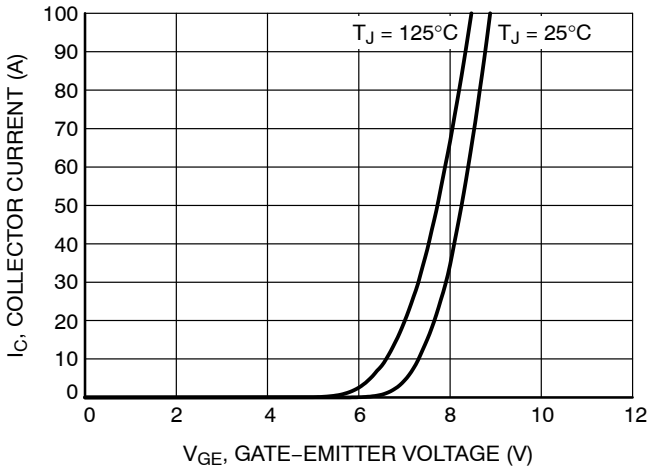

Figure 3. Typical Transfer Characteristics

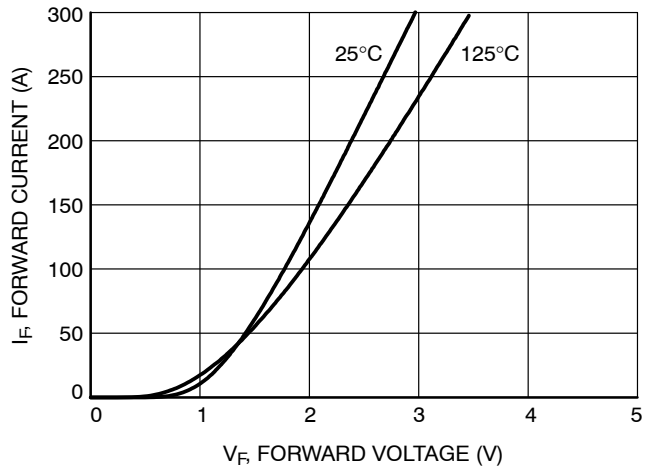

Figure 4. Diode Forward Characteristics

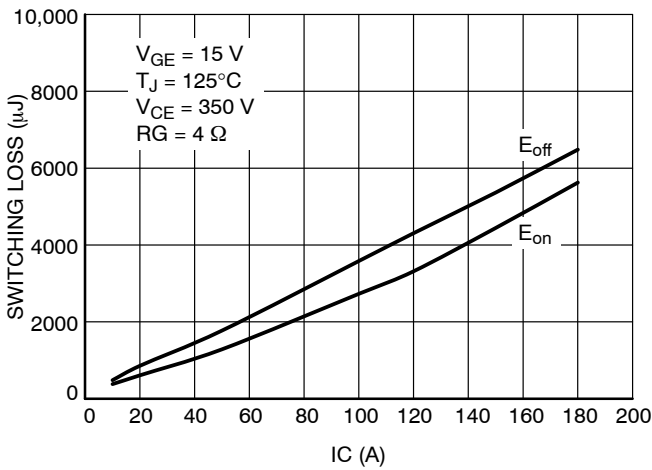

Figure 5. Typical Switching Loss vs. I_C

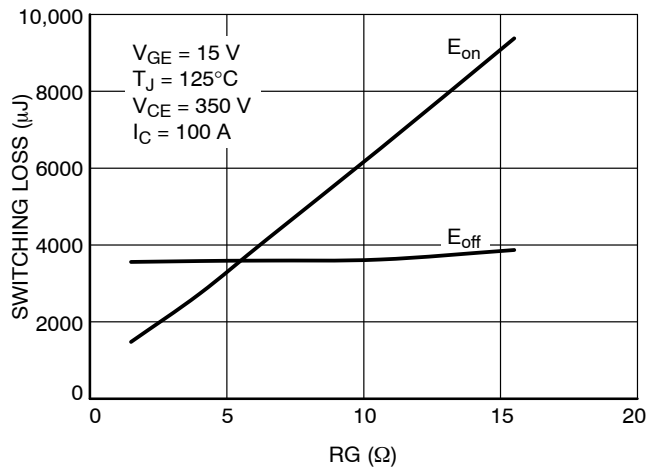

Figure 6. Typical Switching Loss vs. R_G

NXH160T120L2Q1PG, NXH160T120L2Q1SG

TYPICAL CHARACTERISTICS – HALF BRIDGE IGBT AND NEUTRAL POINT FORWARD DIODE

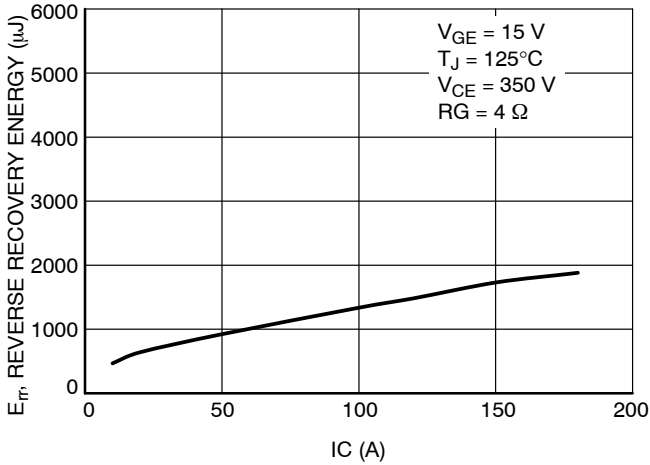

Figure 7. Typical Reverse Recovery Energy Loss vs. IC

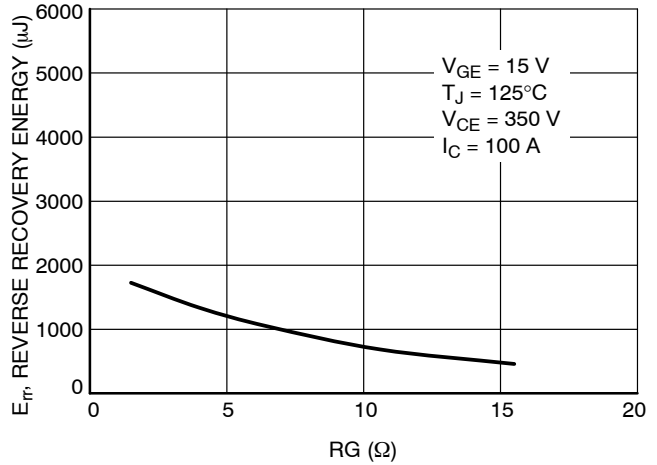

Figure 8. Typical Reverse Recovery Energy Loss vs. R_G

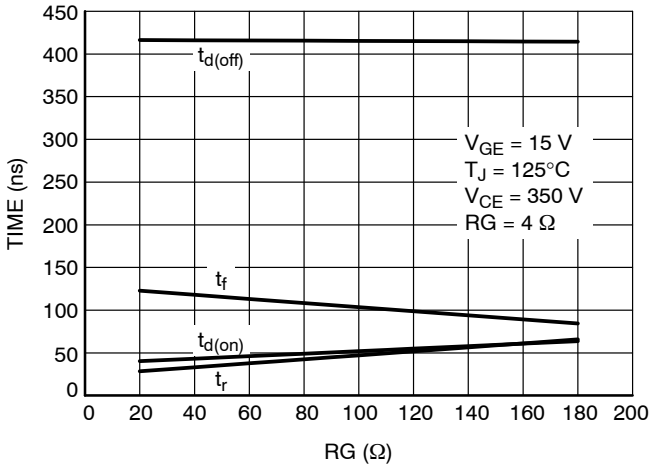

Figure 9. Typical Switching Time vs. IC

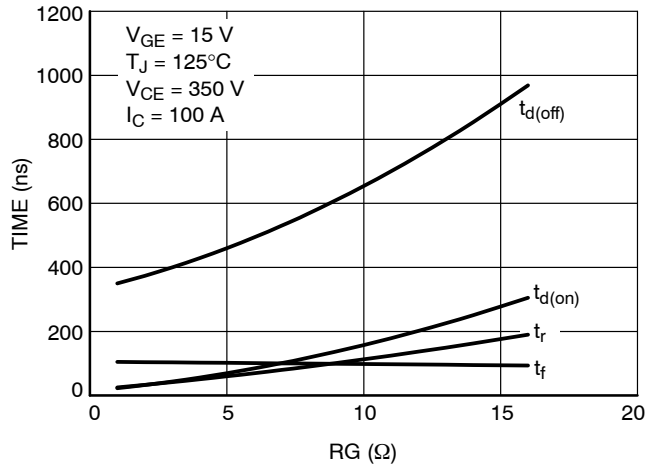

Figure 10. Typical Switching Time vs. R_G

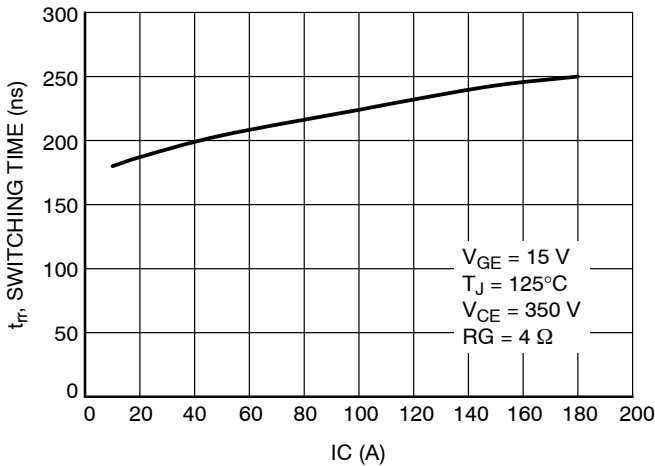

Figure 11. Typical Reverse Recovery Time vs. IC

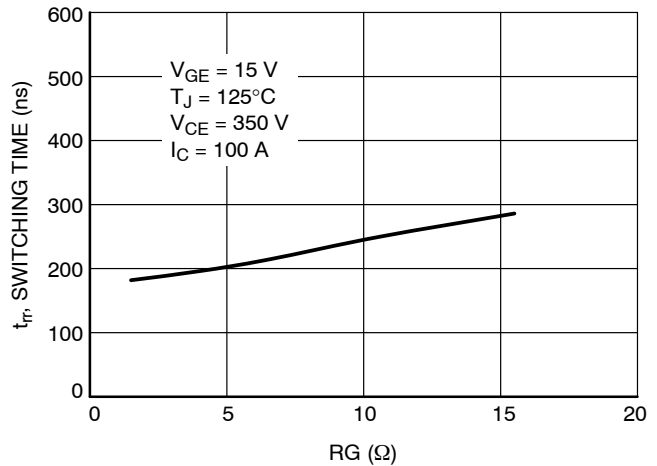

Figure 12. Typical Reverse Recovery Time vs. R_G

NXH160T120L2Q1PG, NXH160T120L2Q1SG

TYPICAL CHARACTERISTICS – HALF BRIDGE IGBT AND NEUTRAL POINT FORWARD DIODE

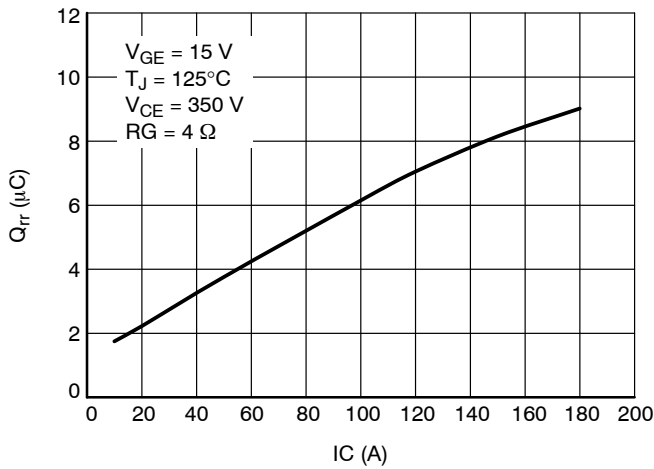

Figure 13. Typical Reverse Recovery Charge vs. IC

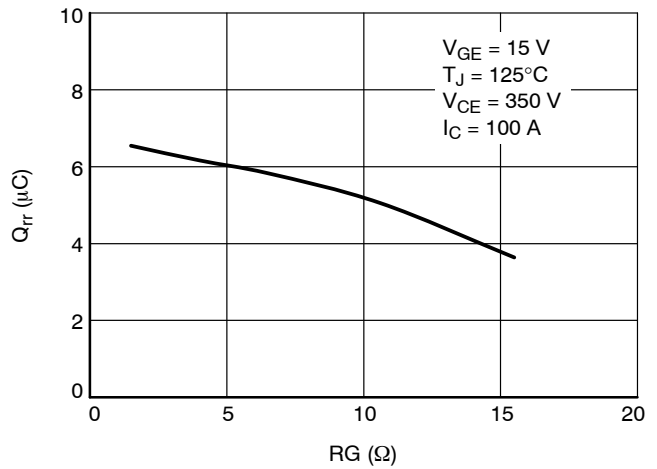

Figure 14. Typical Reverse Recovery Charge vs. RG

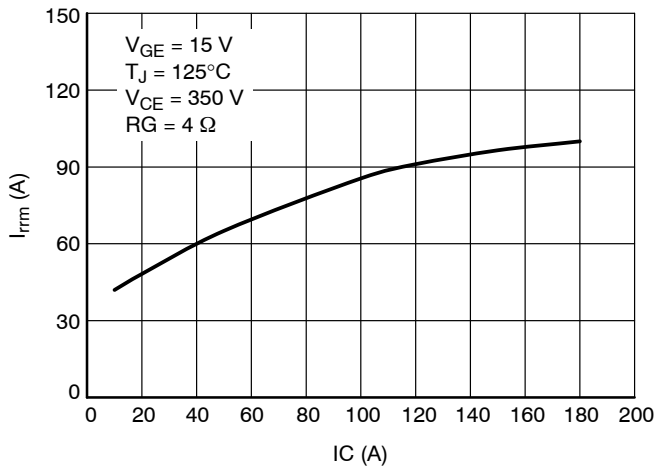

Figure 15. Typical Reverse Recovery Current vs. IC

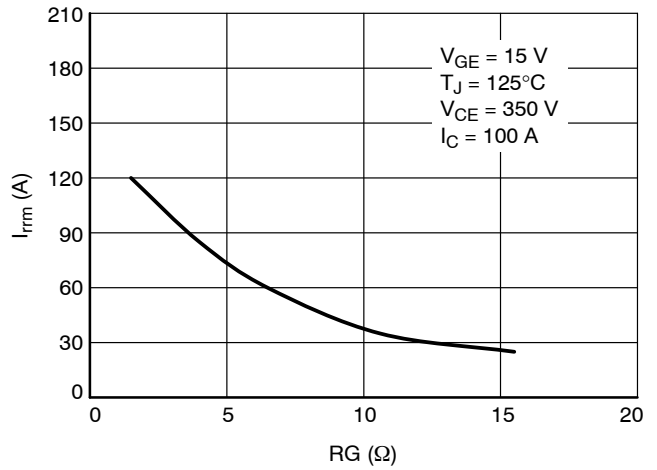

Figure 16. Typical Reverse Recovery Current vs. RG

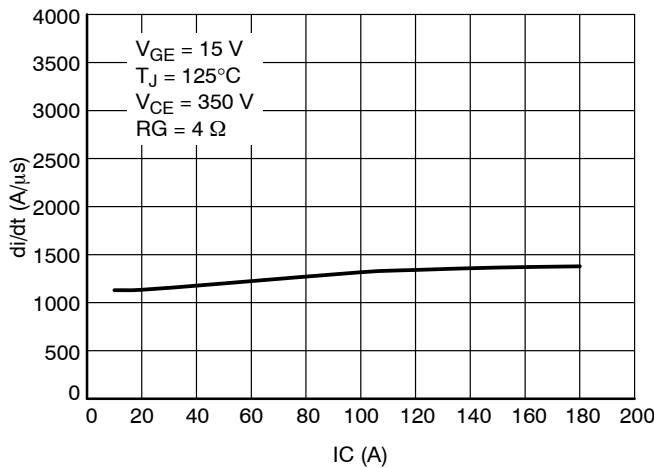

Figure 17. Typical di/dt vs. IC

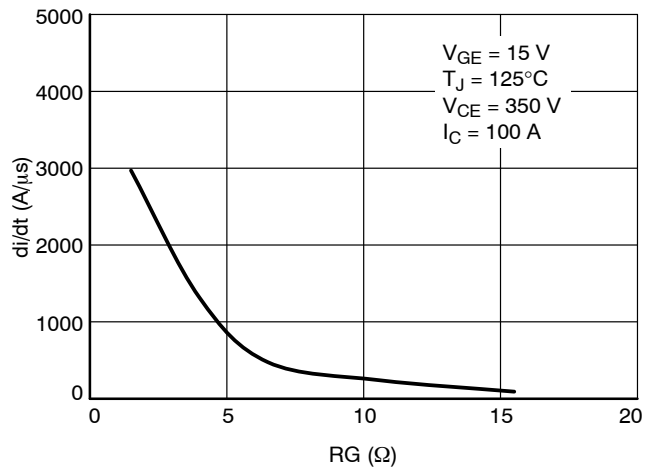

Figure 18. Typical di/dt vs. RG

NXH160T120L2Q1PG, NXH160T120L2Q1SG

TYPICAL CHARACTERISTICS – HALF BRIDGE IGBT AND NEUTRAL POINT FORWARD DIODE

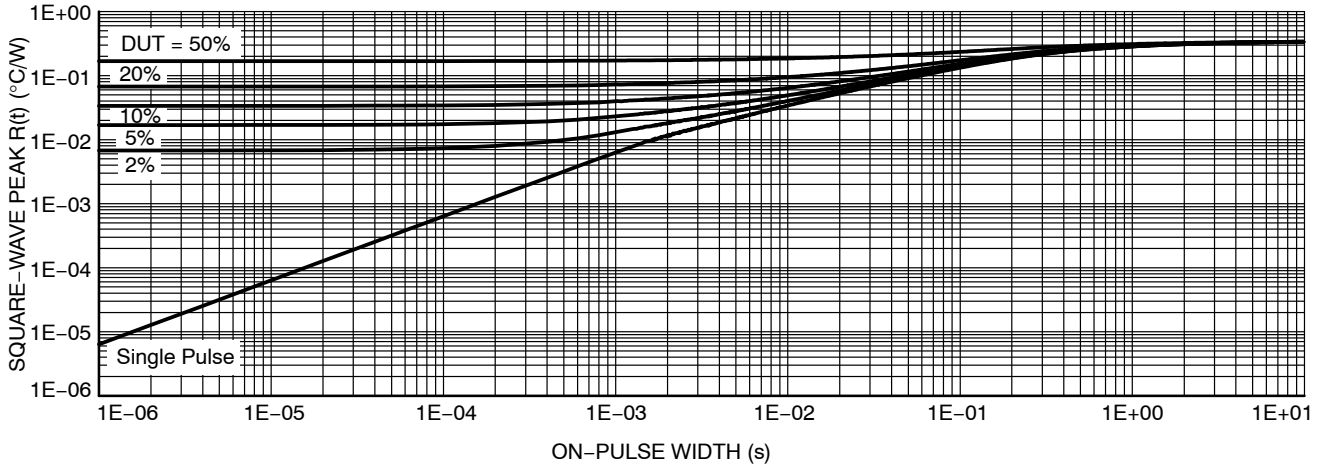

Figure 19. Transient Thermal Impedance (Half Bridge IGBT)

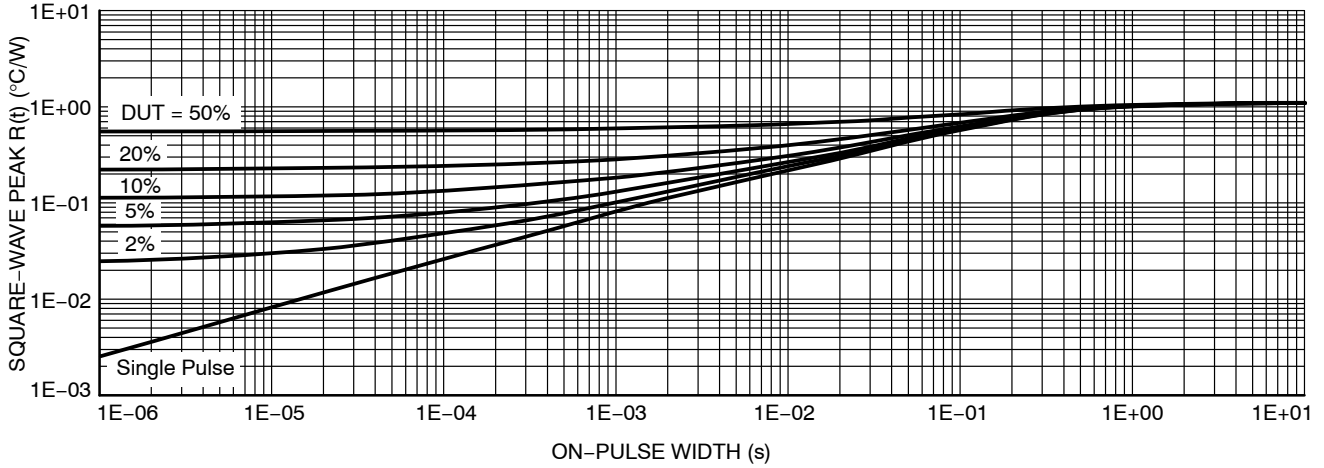

Figure 20. Transient Thermal Impedance (Neutral Point Forward Diode)

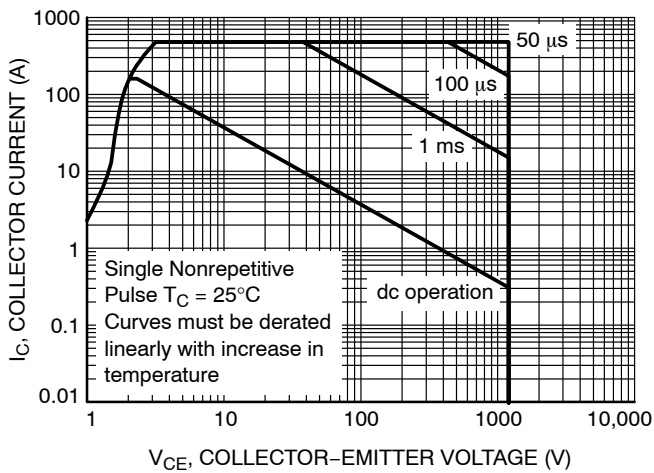

Figure 21. Safe Operating Area

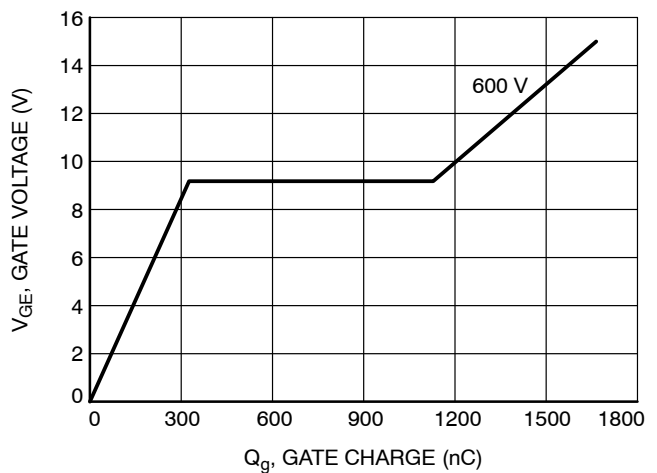

Figure 22. Gate Voltage vs. Gate Charge

NXH160T120L2Q1PG, NXH160T120L2Q1SG

TYPICAL CHARACTERISTICS – NEUTRAL POINT IGBT AND HALF BRIDGE FORWARD DIODE

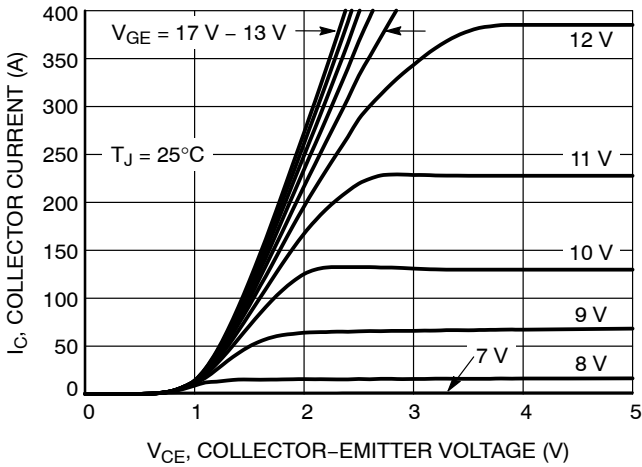

Figure 23. Typical Output Characteristics

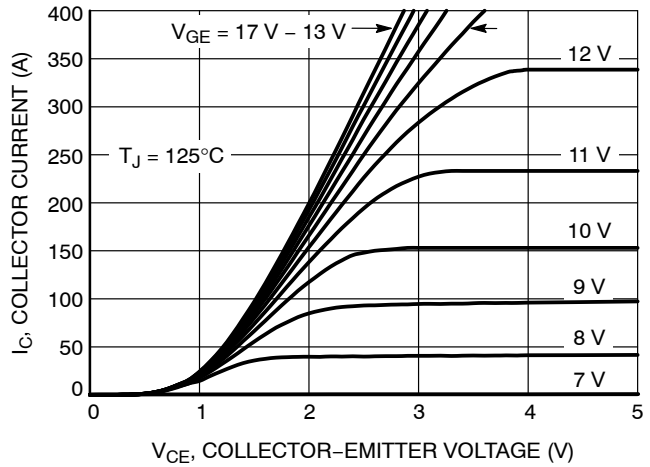

Figure 24. Typical Output Characteristics

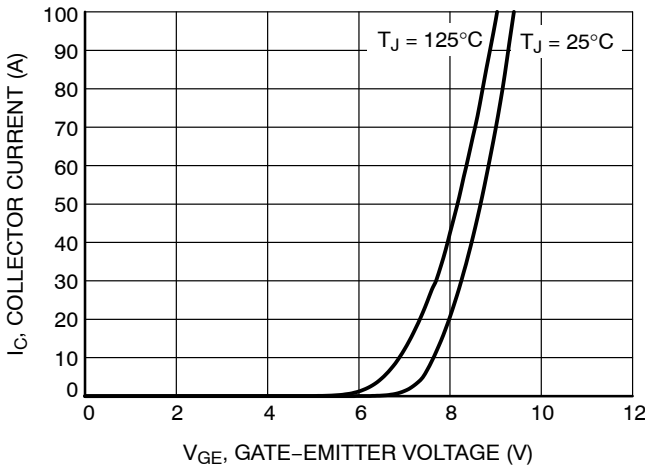

Figure 25. Typical Transfer Characteristics

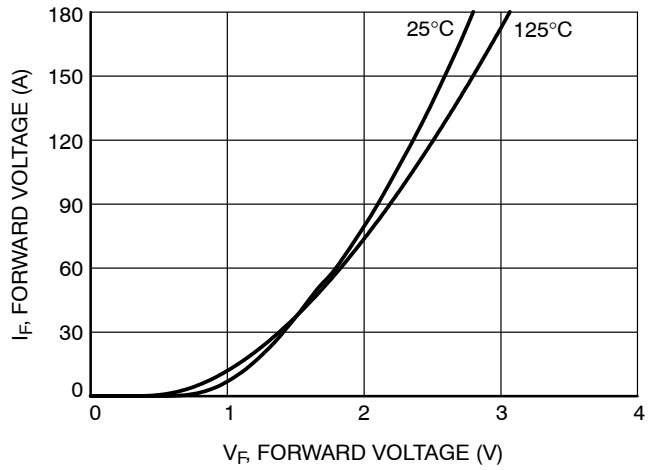

Figure 26. Diode Forward Characteristics

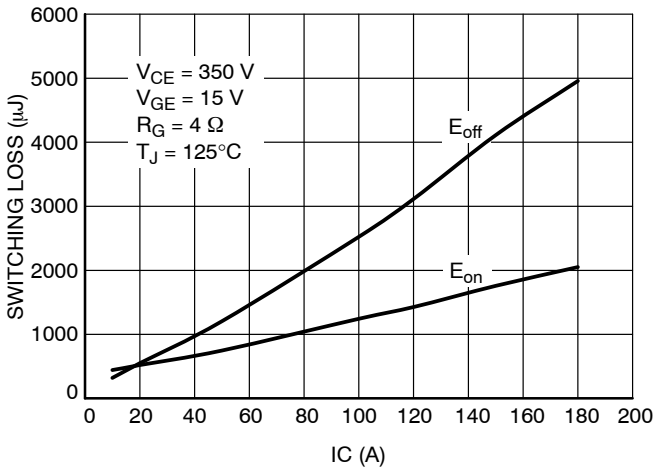

Figure 27. Typical Switching Loss vs. I_C

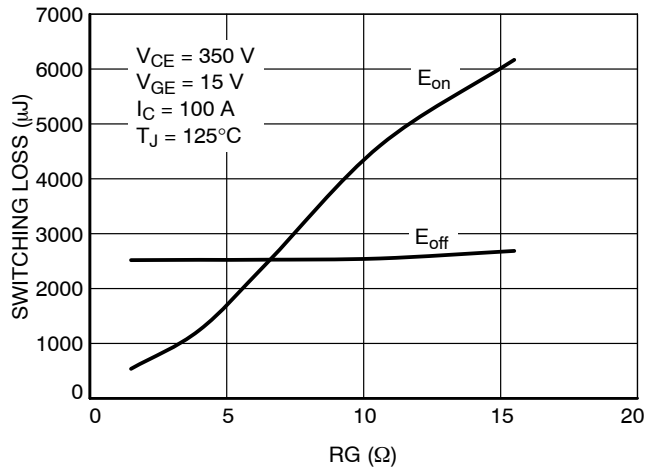

Figure 28. Typical Switching Loss vs. R_G

NXH160T120L2Q1PG, NXH160T120L2Q1SG

TYPICAL CHARACTERISTICS – NEUTRAL POINT IGBT AND HALF BRIDGE FORWARD DIODE

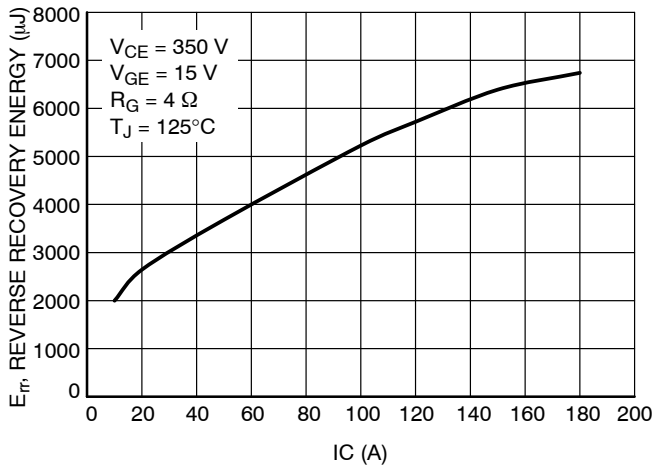

Figure 29. Typical Reverse Recovery Energy Loss vs. IC

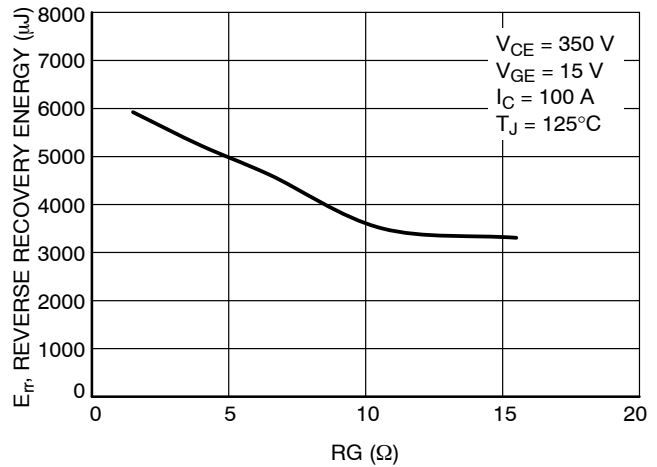

Figure 30. Typical Reverse Recovery Energy Loss vs. R_G

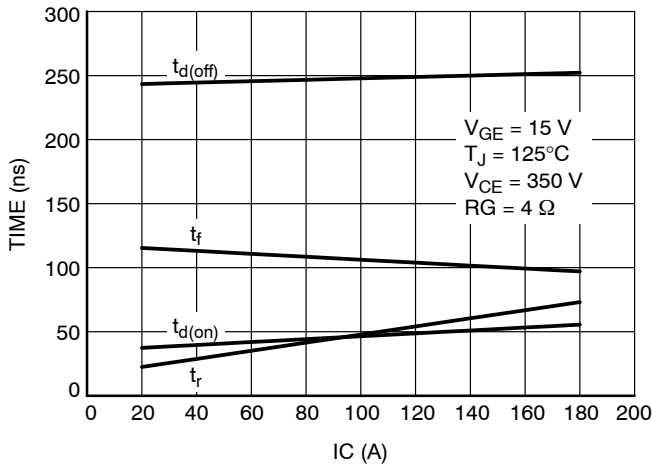

Figure 31. Typical Switching Time vs. IC

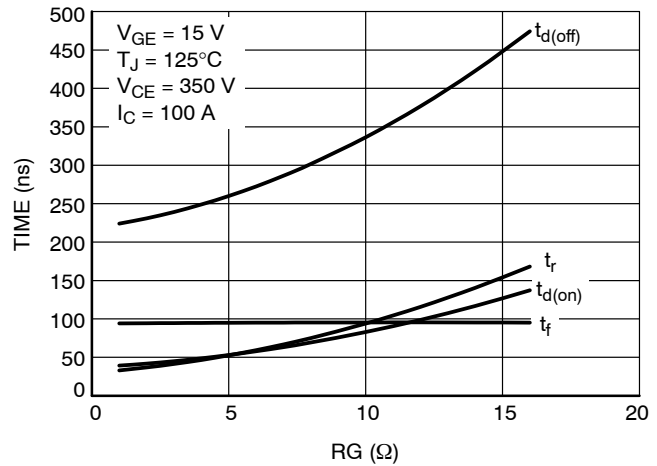

Figure 32. Typical Switching Time vs. R_G

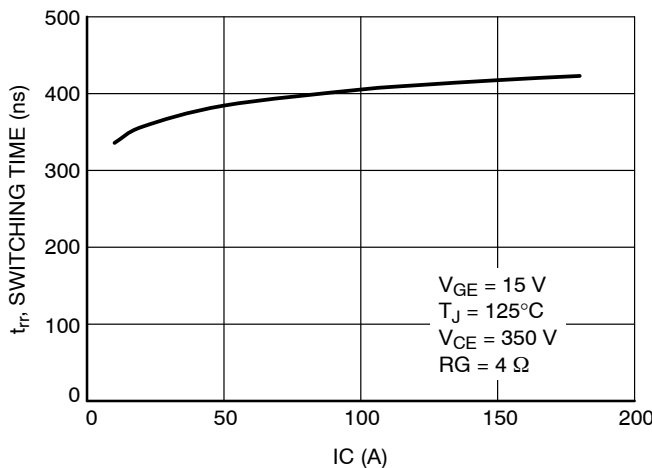

Figure 33. Half Bridge Forward Diode Typical Reverse Recovery Time vs. IC

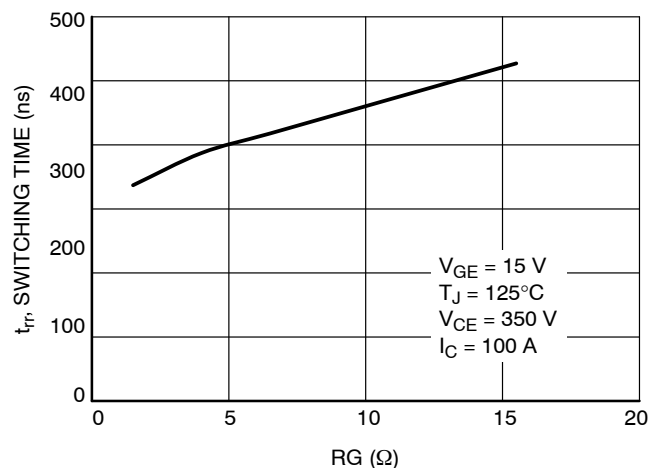

Figure 34. Half Bridge Forward Diode Typical Reverse Recovery Time vs. R_G

NXH160T120L2Q1PG, NXH160T120L2Q1SG

TYPICAL CHARACTERISTICS – NEUTRAL POINT IGBT AND HALF BRIDGE FORWARD DIODE

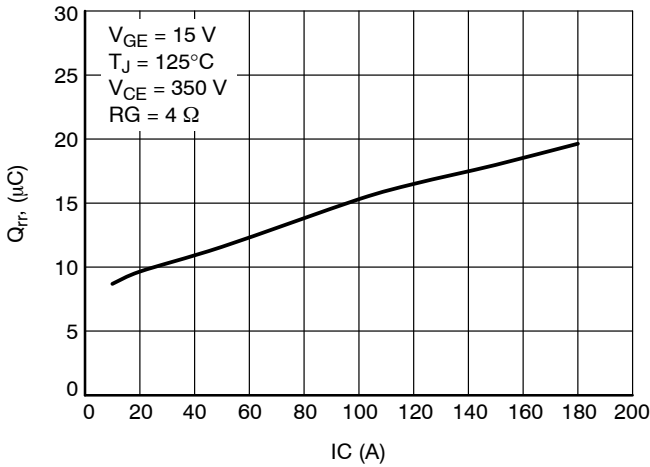

Figure 35. Half Bridge Forward Diode Typical Reverse Recovery Charge vs. IC

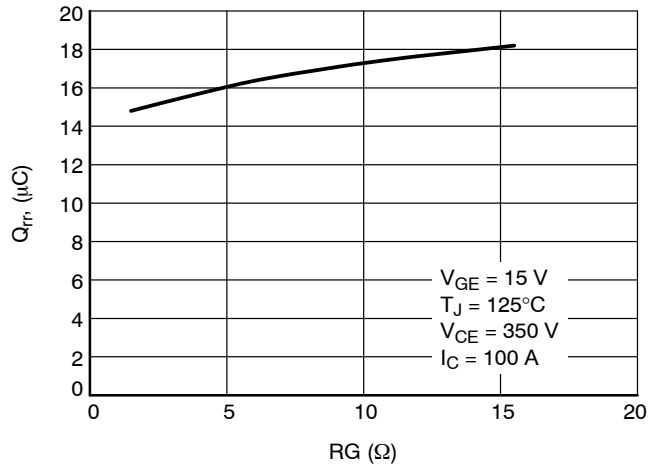

Figure 36. Half Bridge Forward Diode Typical Reverse Recovery Charge vs. RG

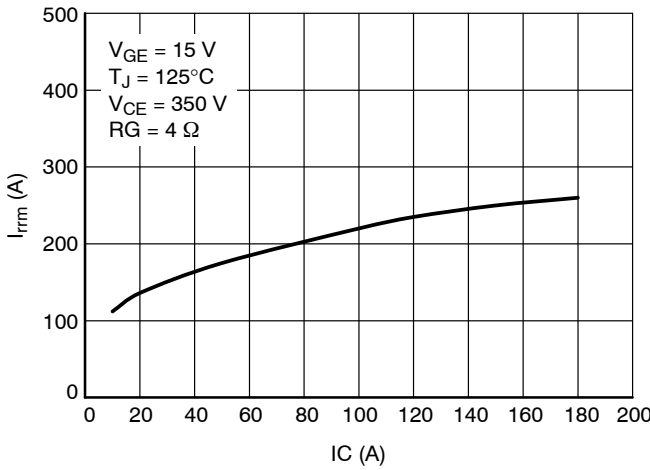

Figure 37. Typical Reverse Recovery Current vs. IC

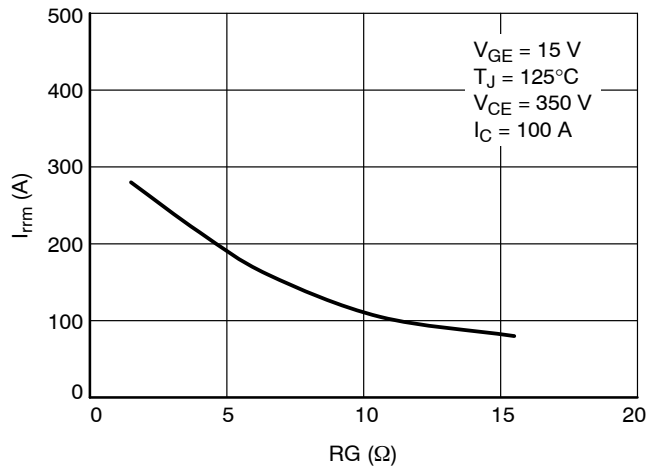

Figure 38. Typical Reverse Recovery Current vs. RG

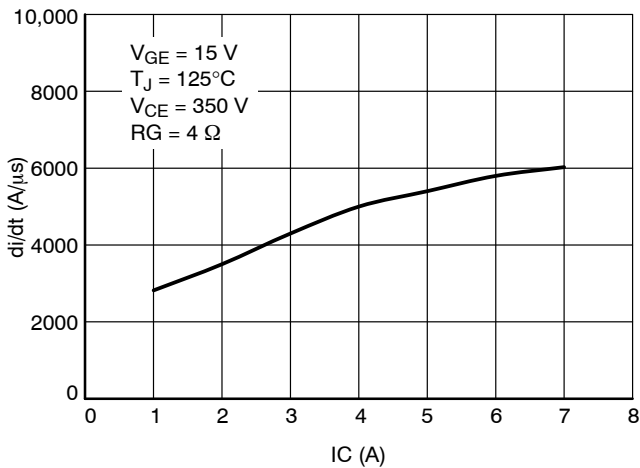

Figure 39. Typical di/dt vs. IC

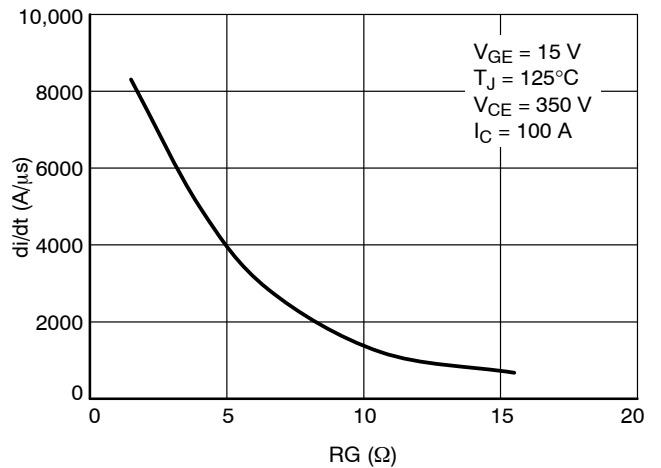

Figure 40. Typical di/dt vs. RG

NXH160T120L2Q1PG, NXH160T120L2Q1SG

TYPICAL CHARACTERISTICS – NEUTRAL POINT IGBT AND HALF BRIDGE FORWARD DIODE

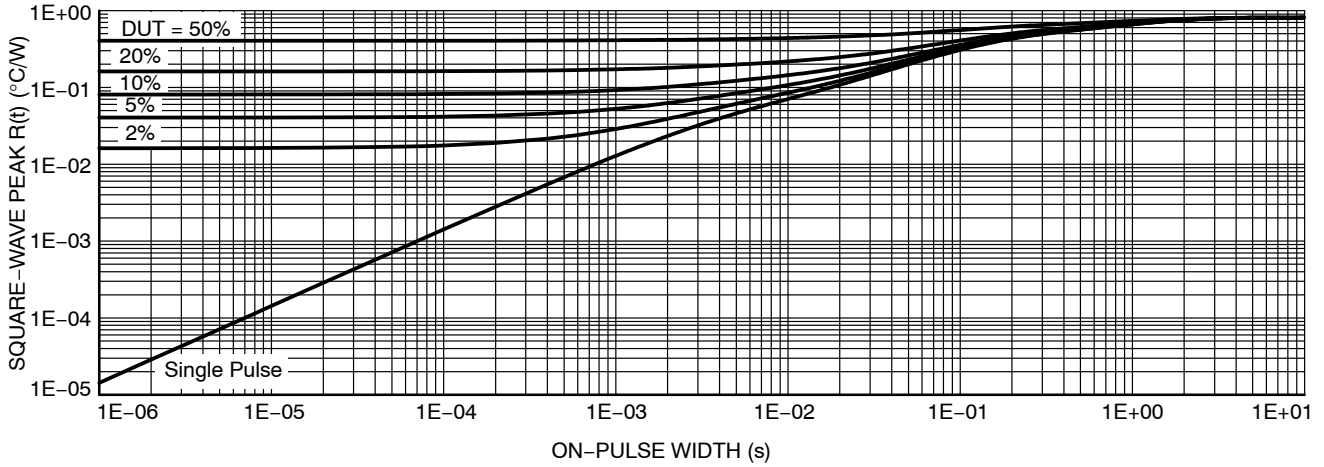

Figure 41. Transient Thermal Impedance (Neutral Point IGBT)

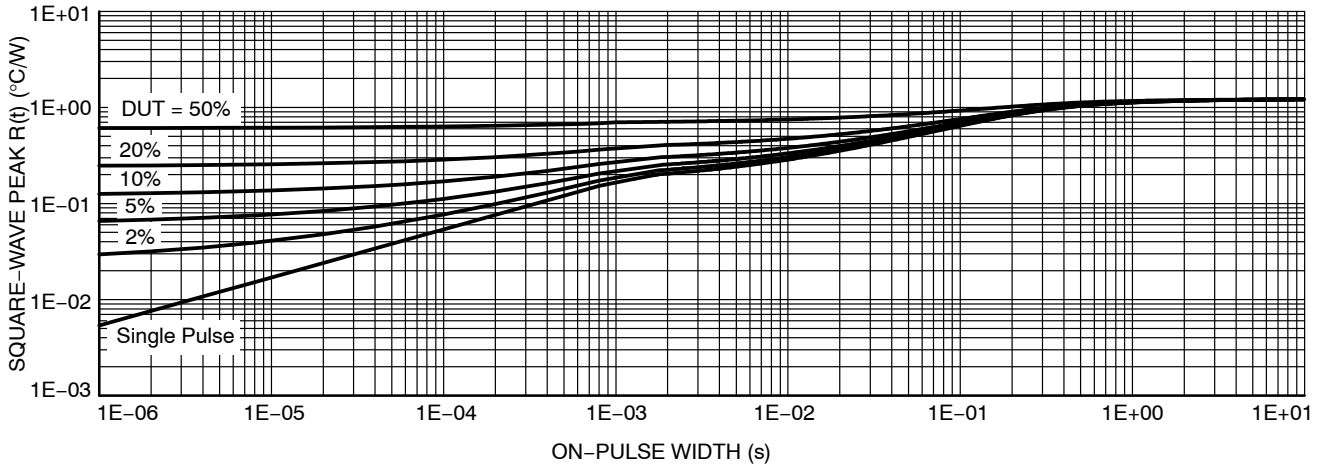

Figure 42. Transient Thermal Impedance (Half Bridge Forward Diode)

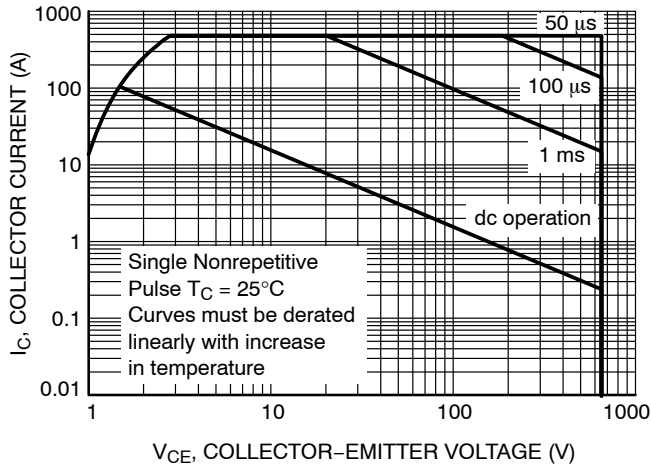

Figure 43. Safe Operating Area

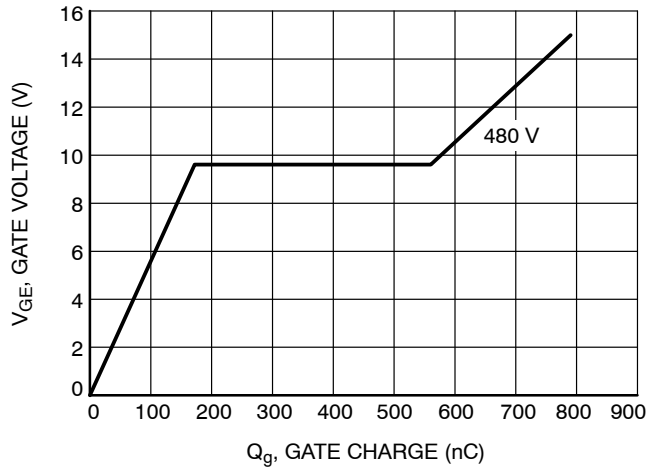

Figure 44. Gate Voltage vs. Gate Charge

NXH160T120L2Q1PG, NXH160T120L2Q1SG

TYPICAL CHARACTERISTICS – HALF BRIDGE INVERSE DIODE

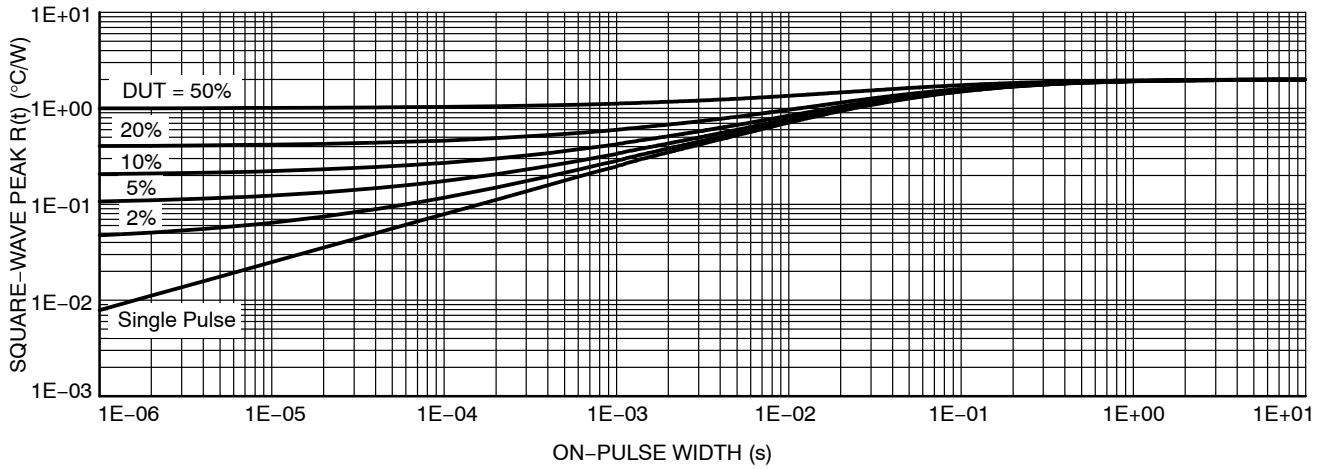

Figure 45. Transient Thermal Impedance

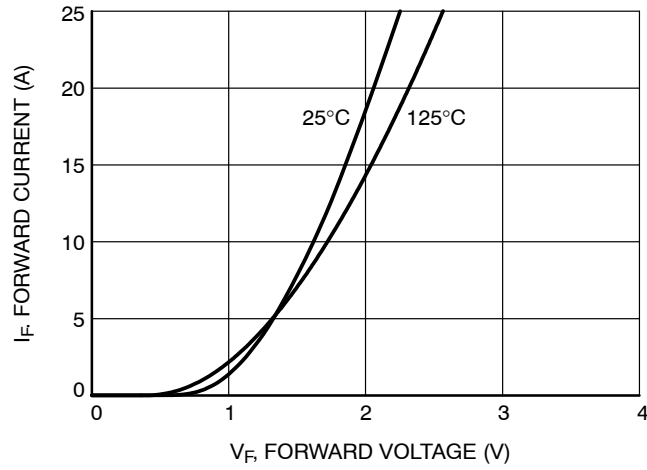

Figure 46. Diode Forward Characteristics

NXH160T120L2Q1PG, NXH160T120L2Q1SG

TYPICAL CHARACTERISTICS – NEUTRAL POINT INVERSE DIODE

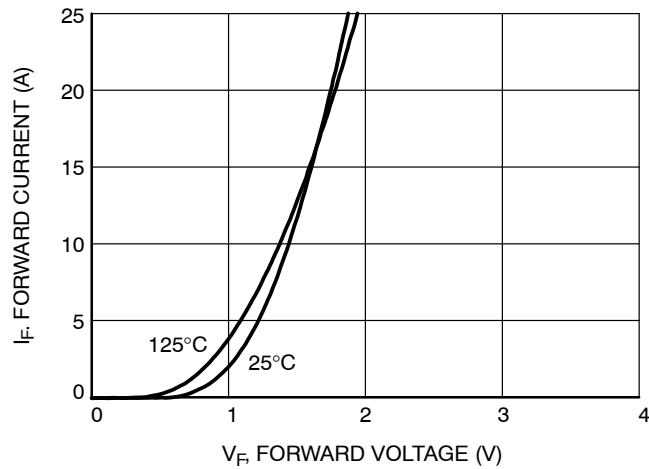

Figure 47. Diode Forward Characteristics

TYPICAL CHARACTERISTICS – THERMISTOR

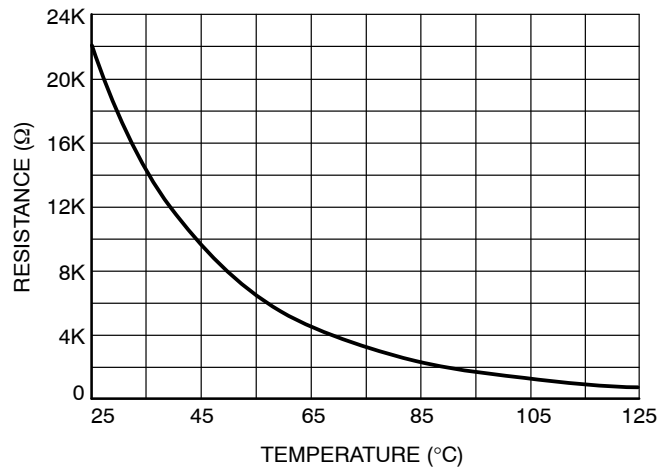

Figure 48. Thermistor Characteristics

ORDERING INFORMATION

Orderable Part Number	Package	Shipping
NXH160T120L2Q1PG (Press Fit)	Q1PACK – Case 180AD (Pb-Free and Halide-Free)	21 Units / Blister Tray
NXH160T120L2Q1SG (Solder Pin)	Q1PACK – Case 180AQ (Pb-Free and Halide-Free)	21 Units / Blister Tray

MECHANICAL CASE OUTLINE

PACKAGE DIMENSIONS

ON Semiconductor®



PIM30, 71x37.4
CASE 180AD
ISSUE E

DATE 28 NOV 2017

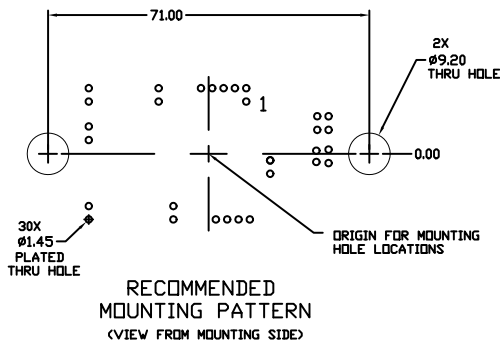
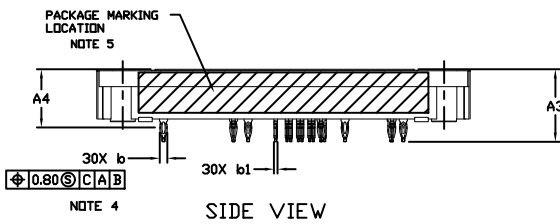
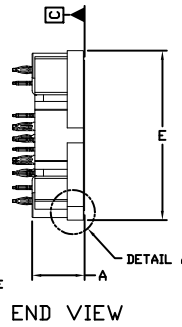
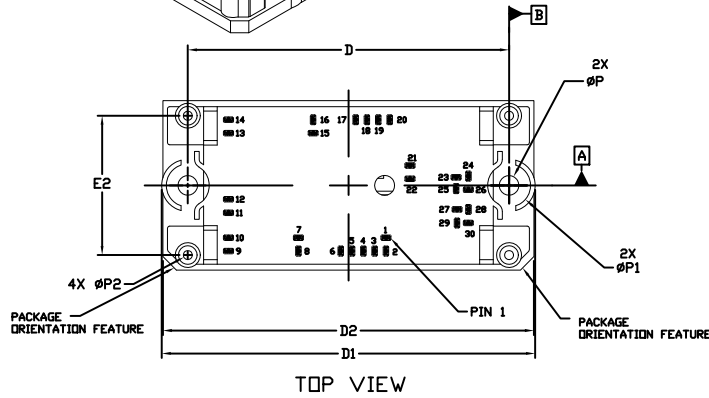
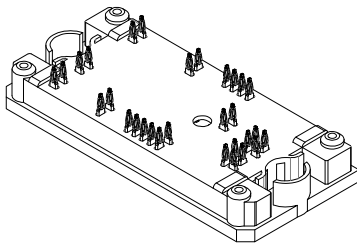

NOTES:

- DIMENSIONING AND TOLERANCING PER ASME Y14.5M, 2009.
- CONTROLLING DIMENSION: MILLIMETERS
- DIMENSIONS b AND b1 APPLY TO THE PLATED TERMINALS AND ARE MEASURED AT DIMENSION A4.
- POSITION OF THE CENTER OF THE TERMINALS IS DETERMINED FROM DATUM B THE CENTER OF DIMENSION D, X DIRECTION, AND FROM DATUM A, Y DIRECTION. POSITIONAL TOLERANCE, AS NOTED IN DRAWING, APPLIES TO EACH TERMINAL IN BOTH DIRECTIONS.
- PACKAGE MARKING IS LOCATED AS SHOWN ON THE SIDE OPPOSITE THE PACKAGE ORIENTATION FEATURES.

MOUNTING HOLE POSITION			MOUNTING HOLE POSITION		
PIN	X	Y	PIN	X	Y
1	8.30	11.55	16	-7.800	-14.50
2	8.30	14.50	17	1.60	-14.50
3	5.80	14.50	18	4.10	-14.50
4	3.30	14.50	19	6.60	-14.50
5	0.80	14.50	20	9.10	-14.50
6	-1.70	14.50	21	13.60	-4.40
7	-11.05	11.55	22	13.60	-1.45
8	-11.05	14.50	23	23.80	-1.80
9	-26.50	14.50	24	26.50	-2.05
10	-26.50	11.55	25	23.80	0.70
11	-26.50	6.05	26	26.50	0.95
12	-26.50	3.05	27	24.00	5.30
13	-26.50	-11.55	28	26.50	5.30
14	-26.50	-14.50	29	24.00	8.30
15	-7.80	-11.55	30	26.50	8.30

NOTE 4

DIM	MILLIMETERS	
	MIN.	NDM.
A	11.10	12.10
A3	15.50	16.50
A4	12.88	BSC
A5	0.00	0.45
b	1.61	1.71
b1	0.75	0.85
D	70.50	71.50
D1	82.00	83.00
D2	81.50	82.50
E	36.90	37.90
E2	30.30	31.30
P	4.30	4.50
P1	9.30	9.70
P2	1.90	2.10

PIN	PIN POSITION		PIN	PIN POSITION	
	X	Y		X	Y
1	8.30	-11.55	16	-7.800	14.50
2	8.30	-14.50	17	1.60	14.50
3	5.80	-14.50	18	4.10	14.50
4	3.30	-14.50	19	6.60	14.50
5	0.80	-14.50	20	9.10	14.50
6	-1.70	-14.50	21	13.60	4.40
7	-11.05	-11.55	22	13.60	1.45
8	-11.05	-14.50	23	23.80	1.80
9	-26.50	-14.50	24	26.50	2.05
10	-26.50	-11.55	25	23.80	-0.70
11	-26.50	-6.05	26	26.50	-0.95
12	-26.50	-3.05	27	24.00	-5.30
13	-26.50	11.55	28	26.50	-5.30
14	-26.50	14.50	29	24.00	-8.30
15	-7.80	11.55	30	26.50	-8.30

GENERIC MARKING DIAGRAM*

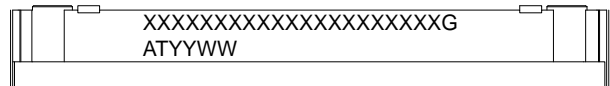

XXXXX = Specific Device Code
G = Pb-Free Package
AT = Assembly & Test Site Code
YYWW = Year and Work Week Code

*This information is generic. Please refer to device data sheet for actual part marking. Pb-Free indicator, "G" or microdot "•", may or may not be present. Some products may not follow the Generic Marking.

DOCUMENT NUMBER:	98AON07115G	Electronic versions are uncontrolled except when accessed directly from the Document Repository. Printed versions are uncontrolled except when stamped "CONTROLLED COPY" in red.
STATUS:	ON SEMICONDUCTOR STANDARD	
NEW STANDARD:		
DESCRIPTION:	PIM30 71X37.4 (PRESS FIT)	PAGE 1 OF 2



ISSUE	REVISION	DATE
O	RELEASED FOR PRODUCTION. REQ. BY C. ENRIQUEZ.	04 DEC 2015
A	MODIFIED TOP AND SIDE VIEWS AND CHANGED MARKING DIAGRAM. REQ. BY A. LAI.	26 FEB 2016
B	CHANGED DIMENSION TABLE CALLOUTS FROM MIN & NOM TO MIN & MAX. REQ. BY F. ESTRADA.	01 FEB 2017
C	CHANGED Y POSITION FOR PIN 15. REQ. BY A. LAI.	09 MAY 2017
D	UPDATED MARKING DIAGRAM CODE INFORMATION. REQ. BY A. LAI.	08 NOV 2017
E	MODIFIED VALUES A, A4, A5 & P2. REQ. BY A. ZHEN.	28 NOV 2017

ON Semiconductor and  are registered trademarks of Semiconductor Components Industries, LLC (SCILLC). SCILLC reserves the right to make changes without further notice to any products herein. SCILLC makes no warranty, representation or guarantee regarding the suitability of its products for any particular purpose, nor does SCILLC assume any liability arising out of the application or use of any product or circuit, and specifically disclaims any and all liability, including without limitation special, consequential or incidental damages. "Typical" parameters which may be provided in SCILLC data sheets and/or specifications can and do vary in different applications and actual performance may vary over time. All operating parameters, including "Typicals" must be validated for each customer application by customer's technical experts. SCILLC does not convey any license under its patent rights nor the rights of others. SCILLC products are not designed, intended, or authorized for use as components in systems intended for surgical implant into the body, or other applications intended to support or sustain life, or for any other application in which the failure of the SCILLC product could create a situation where personal injury or death may occur. Should Buyer purchase or use SCILLC products for any such unintended or unauthorized application, Buyer shall indemnify and hold SCILLC and its officers, employees, subsidiaries, affiliates, and distributors harmless against all claims, costs, damages, and expenses, and reasonable attorney fees arising out of, directly or indirectly, any claim of personal injury or death associated with such unintended or unauthorized use, even if such claim alleges that SCILLC was negligent regarding the design or manufacture of the part. SCILLC is an Equal Opportunity/Affirmative Action Employer. This literature is subject to all applicable copyright laws and is not for resale in any manner.

MECHANICAL CASE OUTLINE PACKAGE DIMENSIONS

ON Semiconductor®



PIM30, 71x37.4
CASE 180AQ
ISSUE A

DATE 25 JUN 2018

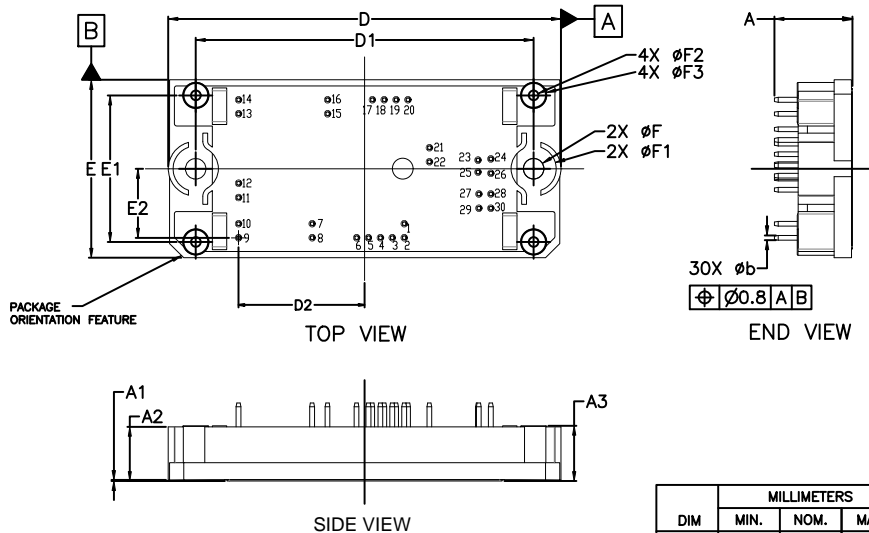
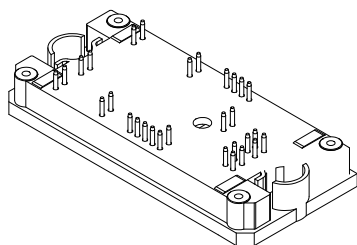

MOUNTING HOLE POSITION			MOUNTING HOLE POSITION		
PIN	X	Y	PIN	X	Y
1	8.30	11.55	16	-7.800	-14.50
2	8.30	14.50	17	1.60	-14.50
3	5.80	14.50	18	4.10	-14.50
4	3.30	14.50	19	6.60	-14.50
5	0.80	14.50	20	9.10	-14.50
6	-1.70	14.50	21	13.60	-4.40
7	-11.05	11.55	22	13.60	-1.45
8	-11.05	14.50	23	23.80	-1.80
9	-26.50	14.50	24	26.50	-2.05
10	-26.50	11.55	25	23.80	0.70
11	-26.50	6.05	26	26.50	0.95
12	-26.50	3.05	27	24.00	5.30
13	-26.50	-11.55	28	26.50	5.30
14	-26.50	-14.50	29	24.00	8.30
15	-7.80	-11.55	30	26.50	8.30

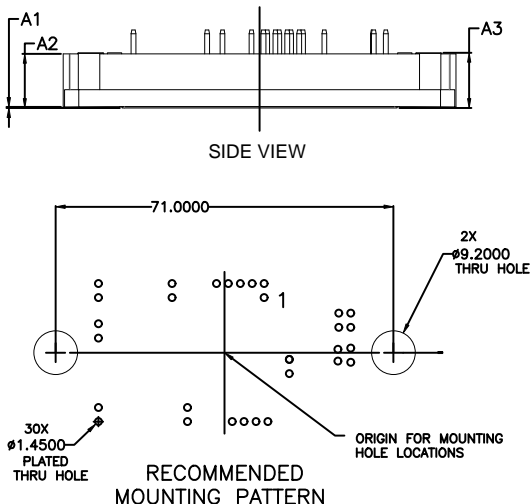

DIM	MILLIMETERS		
	MIN.	NOM.	MAX.
A	15.90	16.40	16.90
A1	---	0.30	0.60
A2	10.90	11.40	11.90
A3	11.10	11.60	12.10
b	0.90	1.00	1.10
D	82.00	82.50	83.00
D1	70.50	71.00	71.50
D2	26.50 REF		
E	36.90	37.40	37.90
E1	30.30	30.80	31.30
E2	14.50 REF		
F	4.30	4.30	4.50
F1	9.5 REF		
F2	2.0 REF		
F3	5.5 REF		

NOTE 4

PIN	PIN POSITION		PIN	PIN POSITION	
	X	Y		X	Y
1	8.30	-11.55	16	-7.800	14.50
2	8.30	-14.50	17	1.60	14.50
3	5.80	-14.50	18	4.10	14.50
4	3.30	-14.50	19	6.60	14.50
5	0.80	-14.50	20	9.10	14.50
6	-1.70	-14.50	21	13.60	4.40
7	-11.05	-11.55	22	13.60	1.45
8	-11.05	-14.50	23	23.80	1.80
9	-26.50	-14.50	24	26.50	2.05
10	-26.50	-11.55	25	23.80	-0.70
11	-26.50	-6.05	26	26.50	-0.95
12	-26.50	-3.05	27	24.00	-5.30
13	-26.50	11.55	28	26.50	-5.30
14	-26.50	14.50	29	24.00	-8.30
15	-7.80	11.55	30	26.50	-8.30

NOTES:

1. DIMENSIONING AND TOLERANCING PER ASME Y14.5M, 2009.
2. CONTROLLING DIMENSION: MILLIMETERS
3. DIMENSIONS b AND b1 APPLY TO THE PLATED TERMINALS AND ARE MEASURED AT DIMENSION A4.
4. POSITION OF THE CENTER OF THE TERMINALS IS DETERMINED FROM DATUM B THE CENTER OF DIMENSION D, X DIRECTION, AND FROM DATUM A, Y DIRECTION. POSITIONAL TOLERANCE, AS NOTED IN DRAWING, APPLIES TO EACH TERMINAL IN BOTH DIRECTIONS.
5. PACKAGE MARKING IS LOCATED AS SHOWN ON THE SIDE OPPOSITE THE PACKAGE ORIENTATION FEATURES.

GENERIC

MARKING DIAGRAM*

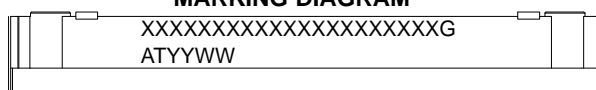

XXXXX = Specific Device Code
G = Pb-Free Package
AT = Assembly & Test Site Code
YYYY = Year and Work Week Code

*This information is generic. Please refer to device data sheet for actual part marking. Pb-Free indicator, "G" or microdot "▪", may or may not be present. Some products may not follow the Generic Marking.

DOCUMENT NUMBER:	98AON86769G	Electronic versions are uncontrolled except when accessed directly from the Document Repository. Printed versions are uncontrolled except when stamped "CONTROLLED COPY" in red.
DESCRIPTION:	PIM30, 71x37.4	PAGE 1 OF 1

ON Semiconductor and are trademarks of Semiconductor Components Industries, LLC dba ON Semiconductor or its subsidiaries in the United States and/or other countries. ON Semiconductor reserves the right to make changes without further notice to any products herein. ON Semiconductor makes no warranty, representation or guarantee regarding the suitability of its products for any particular purpose, nor does ON Semiconductor assume any liability arising out of the application or use of any product or circuit, and specifically disclaims any and all liability, including without limitation special, consequential or incidental damages. ON Semiconductor does not convey any license under its patent rights nor the rights of others.

ON Semiconductor and  are trademarks of Semiconductor Components Industries, LLC dba ON Semiconductor or its subsidiaries in the United States and/or other countries. ON Semiconductor owns the rights to a number of patents, trademarks, copyrights, trade secrets, and other intellectual property. A listing of ON Semiconductor's product/patent coverage may be accessed at www.onsemi.com/site/pdf/Patent-Marking.pdf. ON Semiconductor reserves the right to make changes without further notice to any products herein. ON Semiconductor makes no warranty, representation or guarantee regarding the suitability of its products for any particular purpose, nor does ON Semiconductor assume any liability arising out of the application or use of any product or circuit, and specifically disclaims any and all liability, including without limitation special, consequential or incidental damages. Buyer is responsible for its products and applications using ON Semiconductor products, including compliance with all laws, regulations and safety requirements or standards, regardless of any support or applications information provided by ON Semiconductor. "Typical" parameters which may be provided in ON Semiconductor data sheets and/or specifications can and do vary in different applications and actual performance may vary over time. All operating parameters, including "Typicals" must be validated for each customer application by customer's technical experts. ON Semiconductor does not convey any license under its patent rights nor the rights of others. ON Semiconductor products are not designed, intended, or authorized for use as a critical component in life support systems or any FDA Class 3 medical devices or medical devices with a same or similar classification in a foreign jurisdiction or any devices intended for implantation in the human body. Should Buyer purchase or use ON Semiconductor products for any such unintended or unauthorized application, Buyer shall indemnify and hold ON Semiconductor and its officers, employees, subsidiaries, affiliates, and distributors harmless against all claims, costs, damages, and expenses, and reasonable attorney fees arising out of, directly or indirectly, any claim of personal injury or death associated with such unintended or unauthorized use, even if such claim alleges that ON Semiconductor was negligent regarding the design or manufacture of the part. ON Semiconductor is an Equal Opportunity/Affirmative Action Employer. This literature is subject to all applicable copyright laws and is not for resale in any manner.

PUBLICATION ORDERING INFORMATION

LITERATURE FULFILLMENT:

Literature Distribution Center for ON Semiconductor
19521 E. 32nd Pkwy, Aurora, Colorado 80011 USA
Phone: 303-675-2175 or 800-344-3860 Toll Free USA/Canada
Fax: 303-675-2176 or 800-344-3867 Toll Free USA/Canada
Email: orderlit@onsemi.com

N. American Technical Support: 800-282-9855 Toll Free
USA/Canada
Europe, Middle East and Africa Technical Support:
Phone: 421 33 790 2910

ON Semiconductor Website: www.onsemi.com

Order Literature: <http://www.onsemi.com/orderlit>

For additional information, please contact your local Sales Representative