

# NXH160T120L2Q2F2S1G

## Split T-Type NPC Power Module

1200 V, 160 A IGBT, 650 V, 100 A IGBT

The NXH160T120L2Q2F2S1G is a power module containing a split T-type neutral point clamped three-level inverter, consisting of two 160 A / 1200 V Half Bridge IGBTs with inverse diodes, two Neutral Point 120 A / 650 V rectifiers, two 100 A / 650 V Neutral Point IGBTs with inverse diodes, two Half Bridge 60 A / 1200 V rectifiers and a negative temperature coefficient thermistor (NTC).

### Features

- Split T-type Neutral Point Clamped Three-level Inverter Module
- 1200 V IGBT Specifications:  $V_{CE(SAT)} = 2.15 \text{ V}$ ,  $E_{SW} = 4300 \mu\text{J}$
- 650 V IGBT specifications:  $V_{CE(SAT)} = 1.47 \text{ V}$ ,  $E_{SW} = 2560 \mu\text{J}$
- Baseplate
- Solderable Pins
- Thermistor

### Typical Applications

- Solar Inverters
- Uninterruptible Power Supplies

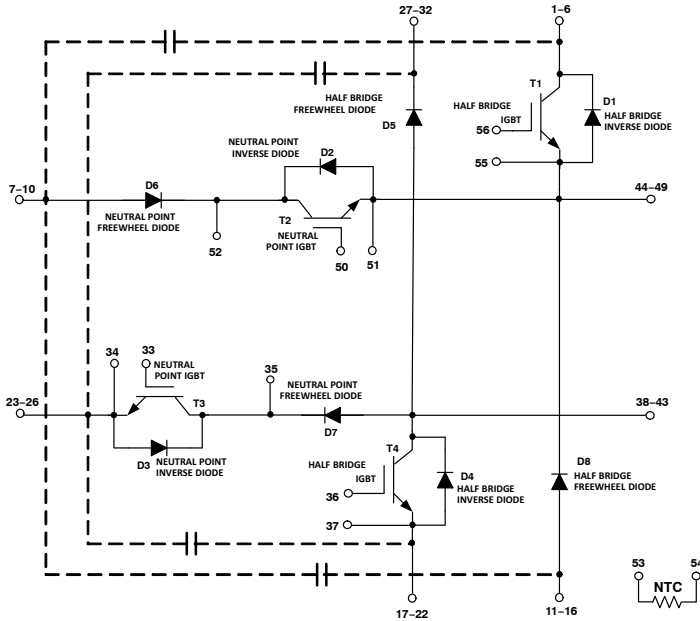
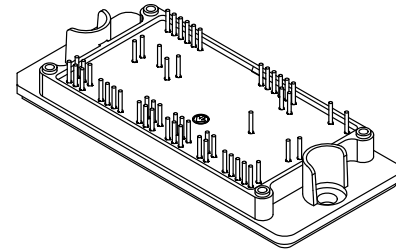

Figure 1. NXH160T120L2Q2F2S1G Schematic Diagram



ON Semiconductor®

[www.onsemi.com](http://www.onsemi.com)



Q2PACK  
CASE 180AK

### MARKING DIAGRAM

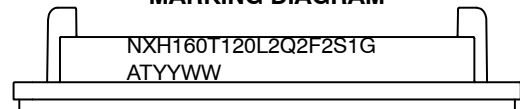

NXH160T120L2Q2F2S1G = Device Code  
YYWW = Year and Work Week Code  
A = Assembly Site Code  
T = Test Site Code  
G = Pb-Free Package

### PIN CONNECTIONS

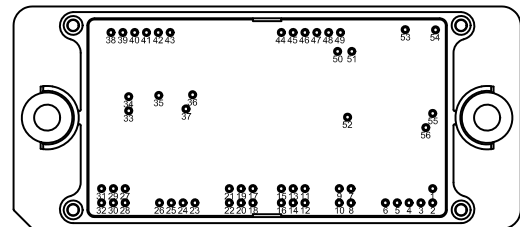

### ORDERING INFORMATION

See detailed ordering and shipping information on page 5 of this data sheet.

# NXH160T120L2Q2F2S1G

**Table 1. ABSOLUTE MAXIMUM RATINGS** (Note 1)  $T_J = 25^\circ\text{C}$  unless otherwise noted

Rating	Symbol	Value	Unit
<b>HALF BRIDGE IGBT</b>			
Collector–Emitter Voltage	$V_{CES}$	1200	V
Gate–Emitter Voltage	$V_{GE}$	$\pm 20$	V
Continuous Collector Current @ $T_h = 80^\circ\text{C}$ ( $T_J = 175^\circ\text{C}$ )	$I_C$	181	A
Pulsed Collector Current ( $T_J = 175^\circ\text{C}$ )	$I_{Cpulse}$	543	A
Maximum Power Dissipation @ $T_h = 80^\circ\text{C}$ ( $T_J = 175^\circ\text{C}$ )	$P_{tot}$	500	W
Short Circuit Withstand Time @ $V_{GE} = 15\text{ V}$ , $V_{CE} = 600\text{ V}$ , $T_J \leq 150^\circ\text{C}$	$T_{sc}$	5	$\mu\text{s}$
Minimum Operating Junction Temperature	$T_{JMIN}$	-40	$^\circ\text{C}$
Maximum Operating Junction Temperature	$T_{JMAX}$	150	$^\circ\text{C}$
<b>NEUTRAL POINT IGBT</b>			
Collector–Emitter Voltage	$V_{CES}$	650	V
Gate–Emitter Voltage	$V_{GE}$	$\pm 20$	V
Continuous Collector Current @ $T_h = 80^\circ\text{C}$ ( $T_J = 175^\circ\text{C}$ )	$I_C$	116	A
Pulsed Collector Current ( $T_J = 175^\circ\text{C}$ )	$I_{Cpulse}$	348	A
Maximum Power Dissipation @ $T_h = 80^\circ\text{C}$ ( $T_J = 175^\circ\text{C}$ )	$P_{tot}$	232	W
Short Circuit Withstand Time @ $V_{GE} = 15\text{ V}$ , $V_{CE} = 400\text{ V}$ , $T_J \leq 150^\circ\text{C}$	$T_{sc}$	5	$\mu\text{s}$
Minimum Operating Junction Temperature	$T_{JMIN}$	-40	$^\circ\text{C}$
Maximum Operating Junction Temperature	$T_{JMAX}$	150	$^\circ\text{C}$
<b>HALF BRIDGE FREEWHEEL DIODE</b>			
Peak Repetitive Reverse Voltage	$V_{RRM}$	1200	V
Continuous Forward Current @ $T_h = 80^\circ\text{C}$ ( $T_J = 175^\circ\text{C}$ )	$I_F$	56	A
Repetitive Peak Forward Current ( $T_J = 175^\circ\text{C}$ , $t_p$ limited by $T_{Jmax}$ )	$I_{FRM}$	150	A
Maximum Power Dissipation @ $T_h = 80^\circ\text{C}$ ( $T_J = 175^\circ\text{C}$ )	$P_{tot}$	142	W
Minimum Operating Junction Temperature	$T_{JMIN}$	-40	$^\circ\text{C}$
Maximum Operating Junction Temperature	$T_{JMAX}$	150	$^\circ\text{C}$
<b>HALF BRIDGE INVERSE DIODE</b>			
Peak Repetitive Reverse Voltage	$V_{RRM}$	1200	V
Continuous Forward Current @ $T_h = 80^\circ\text{C}$ ( $T_J = 175^\circ\text{C}$ )	$I_F$	19	A
Repetitive Peak Forward Current ( $T_J = 175^\circ\text{C}$ , $t_p$ limited by $T_{Jmax}$ )	$I_{FRM}$	50	A
Maximum Power Dissipation @ $T_h = 80^\circ\text{C}$ ( $T_J = 175^\circ\text{C}$ )	$P_{tot}$	63	W
Minimum Operating Junction Temperature	$T_{JMIN}$	-40	$^\circ\text{C}$
Maximum Operating Junction Temperature	$T_{JMAX}$	150	$^\circ\text{C}$
<b>NEUTRAL POINT FREEWHEEL DIODE</b>			
Peak Repetitive Reverse Voltage	$V_{RRM}$	650	V
Continuous Forward Current @ $T_h = 80^\circ\text{C}$ ( $T_J = 175^\circ\text{C}$ )	$I_F$	132	A
Repetitive Peak Forward Current ( $T_J = 175^\circ\text{C}$ , $t_p$ limited by $T_{Jmax}$ )	$I_{FRM}$	300	A
Maximum Power Dissipation @ $T_h = 80^\circ\text{C}$ ( $T_J = 175^\circ\text{C}$ )	$P_{tot}$	198	W
Minimum Operating Junction Temperature	$T_{JMIN}$	-40	$^\circ\text{C}$
Maximum Operating Junction Temperature	$T_{JMAX}$	150	$^\circ\text{C}$
<b>NEUTRAL POINT INVERSE DIODE</b>			
Peak Repetitive Reverse Voltage	$V_{RRM}$	650	V
Continuous Forward Current @ $T_h = 80^\circ\text{C}$ ( $T_J = 175^\circ\text{C}$ )	$I_F$	38	A
Repetitive Peak Forward Current ( $T_J = 175^\circ\text{C}$ , $t_p$ limited by $T_{Jmax}$ )	$I_{FRM}$	110	A
Maximum Power Dissipation @ $T_h = 80^\circ\text{C}$ ( $T_J = 175^\circ\text{C}$ )	$P_{tot}$	79	W
Minimum Operating Junction Temperature	$T_{JMIN}$	-40	$^\circ\text{C}$

# NXH160T120L2Q2F2S1G

**Table 1. ABSOLUTE MAXIMUM RATINGS** (Note 1)  $T_J = 25^\circ\text{C}$  unless otherwise noted

Rating	Symbol	Value	Unit
<b>NEUTRAL POINT INVERSE DIODE</b>			
Maximum Operating Junction Temperature	$T_{JMAX}$	150	$^\circ\text{C}$
<b>THERMAL PROPERTIES</b>			
Storage Temperature range	$T_{stg}$	-40 to 125	$^\circ\text{C}$
<b>INSULATION PROPERTIES</b>			
Isolation test voltage, $t = 1$ sec, 60Hz	$V_{is}$	3000	$V_{RMS}$
Creepage distance		12.7	mm

Stresses exceeding those listed in the Maximum Ratings table may damage the device. If any of these limits are exceeded, device functionality should not be assumed, damage may occur and reliability may be affected.

1. Refer to ELECTRICAL CHARACTERISTICS, RECOMMENDED OPERATING RANGES and/or APPLICATION INFORMATION for Safe Operating parameters.

**Table 2. RECOMMENDED OPERATING RANGES**

Rating	Symbol	Min	Max	Unit
Module Operating Junction Temperature	$T_J$	-40	$(T_{jmax} - 25)$	$^\circ\text{C}$

Functional operation above the stresses listed in the Recommended Operating Ranges is not implied. Extended exposure to stresses beyond the Recommended Operating Ranges limits may affect device reliability.

**Table 3. ELECTRICAL CHARACTERISTICS**  $T_J = 25^\circ\text{C}$  unless otherwise noted

Parameter	Test Conditions	Symbol	Min	Typ	Max	Unit
<b>HALF BRIDGE IGBT CHARACTERISTICS</b>						
Collector-Emitter Cutoff Current	$V_{GE} = 0\text{ V}, V_{CE} = 1200\text{ V}$	$I_{CES}$	-	-	500	$\mu\text{A}$
Collector-Emitter Saturation Voltage	$V_{GE} = 15\text{ V}, I_C = 160\text{ A}, T_J = 25^\circ\text{C}$	$V_{CE(sat)}$	-	2.15	2.7	V
	$V_{GE} = 15\text{ V}, I_C = 160\text{ A}, T_J = 150^\circ\text{C}$		-	2.08	-	
Gate-Emitter Threshold Voltage	$V_{GE} = V_{CE}, I_C = 6\text{ mA}$	$V_{GE(TH)}$	-	5.53	6.4	V
Gate Leakage Current	$V_{GE} = 20\text{ V}, V_{CE} = 0\text{ V}$	$I_{GES}$	-	-	500	nA
Turn-on Delay Time	$T_J = 25^\circ\text{C}$ $V_{CE} = 350\text{ V}, I_C = 100\text{ A}$ $V_{GE} = \pm 15\text{ V}, R_G = 4\ \Omega$	$t_{d(on)}$	-	105	-	ns
Rise Time		$t_r$	-	50	-	
Turn-off Delay Time		$t_{d(off)}$	-	270	-	
Fall Time		$t_f$	-	55	-	
Turn-on Switching Loss per Pulse		$E_{on}$	-	1700	-	
Turn off Switching Loss per Pulse	$E_{off}$	-	2600	-		
Turn-on Delay Time	$T_J = 125^\circ\text{C}$ $V_{CE} = 350\text{ V}, I_C = 100\text{ A}$ $V_{GE} = \pm 15\text{ V}, R_G = 4\ \Omega$	$t_{d(on)}$	-	95	-	ns
Rise Time		$t_r$	-	55	-	
Turn-off Delay Time		$t_{d(off)}$	-	285	-	
Fall Time		$t_f$	-	150	-	
Turn-on Switching Loss per Pulse		$E_{on}$	-	2300	-	
Turn off Switching Loss per Pulse	$E_{off}$	-	4600	-		
Input Capacitance	$V_{CE} = 25\text{ V}, V_{GE} = 0\text{ V}, f = 10\text{ kHz}$	$C_{ies}$	-	38800	-	pF
Output Capacitance		$C_{oes}$	-	800	-	
Reverse Transfer Capacitance		$C_{res}$	-	680	-	
Total Gate Charge	$V_{CE} = 600\text{ V}, I_C = 160\text{ A}, V_{GE} = 15\text{ V}$	$Q_g$	-	1600	-	nC
Thermal Resistance - chip-to-heatsink	Thermal grease, Thickness < 100 $\mu\text{m}$ , $\lambda = 0.84\text{ W/mK}$	$R_{thJH}$	-	0.19	-	$^\circ\text{C/W}$

# NXH160T120L2Q2F2S1G

**Table 3. ELECTRICAL CHARACTERISTICS**  $T_J = 25^\circ\text{C}$  unless otherwise noted

Parameter	Test Conditions	Symbol	Min	Typ	Max	Unit
<b>NEUTRAL POINT FREEWHEEL DIODE CHARACTERISTICS</b>						
Diode Reverse Leakage Current	$V_R = 650\text{ V}$	$I_R$	–	–	100	$\mu\text{A}$
Diode Forward Voltage	$I_F = 120\text{ A}, T_J = 25^\circ\text{C}$	$V_F$	–	1.24	1.5	V
	$I_F = 120\text{ A}, T_J = 150^\circ\text{C}$		–	1.20	–	
Reverse Recovery Time	$T_J = 25^\circ\text{C}$ $V_{CE} = 350\text{ V}, I_C = 100\text{ A}$ $V_{GE} = \pm 15\text{ V}, R_G = 4\ \Omega$	$t_{rr}$	–	50	–	ns
Reverse Recovery Charge		$Q_{rr}$	–	1700	–	nC
Peak Reverse Recovery Current		$I_{RRM}$	–	59	–	A
Peak Rate of Fall of Recovery Current		$di/dt$	–	2500	–	$\text{A}/\mu\text{s}$
Reverse Recovery Energy		$E_{rr}$	–	380	–	$\mu\text{J}$
Reverse Recovery Time		$T_J = 125^\circ\text{C}$ $V_{CE} = 350\text{ V}, I_C = 100\text{ A}$ $V_{GE} = \pm 15\text{ V}, R_G = 4\ \Omega$	$t_{rr}$	–	77	–
Reverse Recovery Charge	$Q_{rr}$		–	3600	–	nC
Peak Reverse Recovery Current	$I_{RRM}$		–	77	–	A
Peak Rate of Fall of Recovery Current	$di/dt$		–	1900	–	$\text{A}/\mu\text{s}$
Reverse Recovery Energy	$E_{rr}$		–	780	–	$\mu\text{J}$
Thermal Resistance – chip-to-heatsink	Thermal grease, Thickness < 100 $\mu\text{m}$ , $\lambda = 0.84\text{ W/mK}$		$R_{thJH}$	–	0.48	–

### NEUTRAL POINT IGBT CHARACTERISTICS

Collector–Emitter Cutoff Current	$V_{GE} = 0\text{ V}, V_{CE} = 650\text{ V}$	$I_{CES}$	–	–	300	$\mu\text{A}$	
Collector–Emitter Saturation Voltage	$V_{GE} = 15\text{ V}, I_C = 100\text{ A}, T_J = 25^\circ\text{C}$	$V_{CE(sat)}$	–	1.47	1.8	V	
	$V_{GE} = 15\text{ V}, I_C = 100\text{ A}, T_J = 150^\circ\text{C}$		–	1.50	–		
Gate–Emitter Threshold Voltage	$V_{GE} = V_{CE}, I_C = 1.2\text{ mA}$	$V_{GE(TH)}$	–	5.30	6.4	V	
Gate Leakage Current	$V_{GE} = 20\text{ V}, V_{CE} = 0\text{ V}$	$I_{GES}$	–	–	300	nA	
Turn–on Delay Time	$T_J = 25^\circ\text{C}$ $V_{CE} = 350\text{ V}, I_C = 100\text{ A}$ $V_{GE} = \pm 15\text{ V}, R_G = 4\ \Omega$	$t_{d(on)}$	–	50	–	ns	
Rise Time		$t_r$	–	35	–		
Turn–off Delay Time		$t_{d(off)}$	–	135	–		
Fall Time		$t_f$	–	40	–		
Turn–on Switching Loss per Pulse		$E_{on}$	–	870	–		$\mu\text{J}$
Turn off Switching Loss per Pulse		$E_{off}$	–	1690	–		
Turn–on Delay Time	$T_J = 125^\circ\text{C}$ $V_{CE} = 350\text{ V}, I_C = 100\text{ A}$ $V_{GE} = \pm 15\text{ V}, R_G = 4\ \Omega$	$t_{d(on)}$	–	50	–	ns	
Rise Time		$t_r$	–	37	–		
Turn–off Delay Time		$t_{d(off)}$	–	145	–		
Fall Time		$t_f$	–	65	–		
Turn–on Switching Loss per Pulse		$E_{on}$	–	1300	–		$\mu\text{J}$
Turn off Switching Loss per Pulse		$E_{off}$	–	2500	–		
Input Capacitance	$V_{CE} = 25\text{ V}, V_{GE} = 0\text{ V}, f = 10\text{ kHz}$	$C_{ies}$	–	18800	–	pF	
Output Capacitance		$C_{oes}$	–	560	–		
Reverse Transfer Capacitance		$C_{res}$	–	500	–		
Total Gate Charge	$V_{CE} = 480\text{ V}, I_C = 80\text{ A}, V_{GE} = 15\text{ V}$	$Q_g$	–	790	–	nC	
Thermal Resistance – chip-to-heatsink	Thermal grease, Thickness < 100 $\mu\text{m}$ , $\lambda = 0.84\text{ W/mK}$	$R_{thJH}$	–	0.41	–	$^\circ\text{C}/\text{W}$	

# NXH160T120L2Q2F2S1G

**Table 3. ELECTRICAL CHARACTERISTICS**  $T_J = 25^\circ\text{C}$  unless otherwise noted

Parameter	Test Conditions	Symbol	Min	Typ	Max	Unit
<b>HALF BRIDGE FREEWHEEL DIODE CHARACTERISTICS</b>						
Diode Reverse Leakage Current	$V_R = 1200\text{ V}$	$I_R$	–	–	100	$\mu\text{A}$
Diode Forward Voltage	$I_F = 60\text{ A}, T_J = 25^\circ\text{C}$	$V_F$	–	2.63	3.3	V
	$I_F = 60\text{ A}, T_J = 150^\circ\text{C}$		–	2.12	–	
Reverse Recovery Time	$T_J = 25^\circ\text{C}$ $V_{CE} = 350\text{ V}, I_C = 100\text{ A}$ $V_{GE} = \pm 15\text{ V}, R_G = 4\ \Omega$	$t_{rr}$	–	320	–	ns
Reverse Recovery Charge		$Q_{rr}$	–	3700	–	nC
Peak Reverse Recovery Current		$I_{RRM}$	–	68	–	A
Peak Rate of Fall of Recovery Current		$di/dt$	–	3000	–	$\text{A}/\mu\text{s}$
Reverse Recovery Energy		$E_{rr}$	–	1150	–	$\mu\text{J}$
Reverse Recovery Time		$T_J = 125^\circ\text{C}$ $V_{CE} = 350\text{ V}, I_C = 100\text{ A}$ $V_{GE} = \pm 15\text{ V}, R_G = 4\ \Omega$	$t_{rr}$	–	520	–
Reverse Recovery Charge	$Q_{rr}$		–	9000	–	nC
Peak Reverse Recovery Current	$I_{RRM}$		–	102	–	A
Peak Rate of Fall of Recovery Current	$di/dt$		–	2600	–	$\text{A}/\mu\text{s}$
Reverse Recovery Energy	$E_{rr}$		–	2750	–	$\mu\text{J}$
Thermal Resistance – chip-to-heatsink	Thermal grease, Thickness < 100 $\mu\text{m}$ , $\lambda = 0.84\text{ W/mK}$		$R_{thJH}$	–	0.67	–

### HALF BRIDGE INVERSE DIODE CHARACTERISTICS

Diode Forward Voltage	$I_F = 7\text{ A}, T_J = 25^\circ\text{C}$	$V_F$	–	1.92	2.80	V
	$I_F = 7\text{ A}, T_J = 150^\circ\text{C}$		–	1.37	–	
Thermal Resistance – chip-to-heatsink	Thermal grease, Thickness < 100 $\mu\text{m}$ , $\lambda = 0.84\text{ W/mK}$	$R_{thJH}$	–	1.52	–	$^\circ\text{C/W}$

### NEUTRAL POINT INVERSE DIODE CHARACTERISTICS

Diode Forward Voltage	$I_F = 30\text{ A}, T_J = 25^\circ\text{C}$	$V_F$	–	2.72	3.2	V
	$I_F = 30\text{ A}, T_J = 150^\circ\text{C}$		–	1.91	–	
Thermal Resistance – chip-to-heatsink	Thermal grease, Thickness 100 $\mu\text{m}$ , $\lambda = 0.84\text{ W/mK}$	$R_{thJH}$	–	1.21	–	$^\circ\text{C/W}$

### THERMISTOR CHARACTERISTICS

Nominal resistance		$R_{25}$	–	22	–	$\text{k}\Omega$
Nominal resistance	$T = 100^\circ\text{C}$	$R_{100}$	–	1486	–	$\Omega$
Deviation of $R_{25}$		$\Delta R/R$	–5	–	5	%
Power dissipation		$P_D$	–	200	–	mW
Power dissipation constant			–	2	–	$\text{mW/K}$
B-value	$B(25/50)$ , tolerance $\pm 3\%$		–	3950	–	K
B-value	$B(25/100)$ , tolerance $\pm 3\%$		–	3998	–	K

### ORDERING INFORMATION

Device	Marking	Package	Shipping
NXH160T120L2Q2F2S1G	NXH160T120L2Q2F2S1G	Q2PACK – Case 180AK (Pb-Free and Halide-Free)	12 Units / Blister Tray

# NXH160T120L2Q2F2S1G

## TYPICAL CHARACTERISTICS – Half Bridge IGBT and Neutral Point Diode

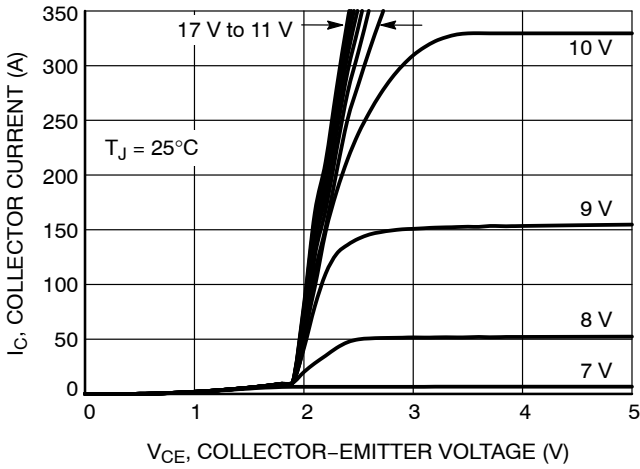

**Figure 1. IGBT Typical Output Characteristics**

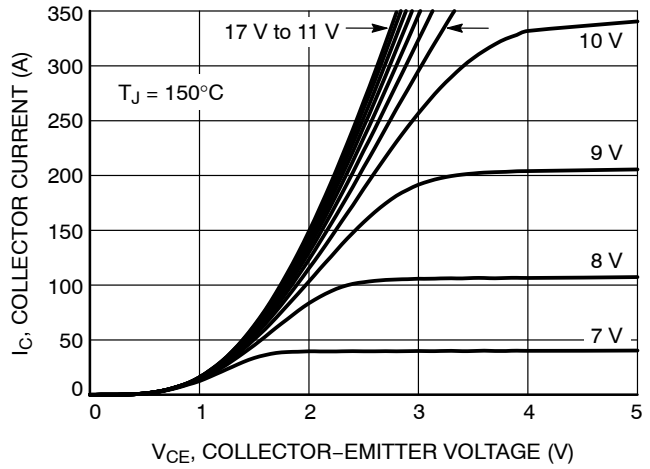

**Figure 2. IGBT Typical Output Characteristics**

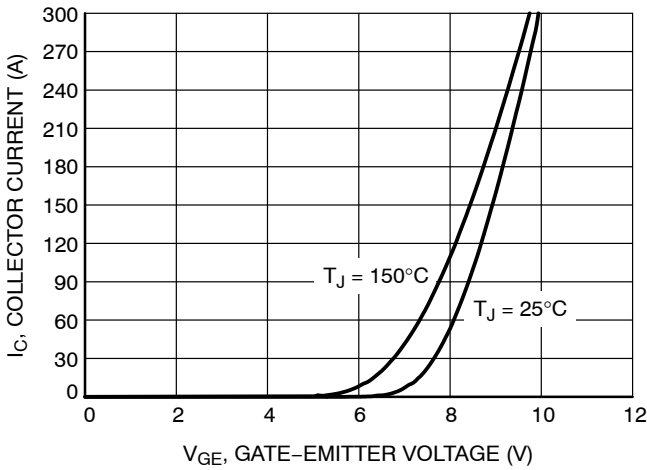

**Figure 3. IGBT Typical Transfer Characteristics**

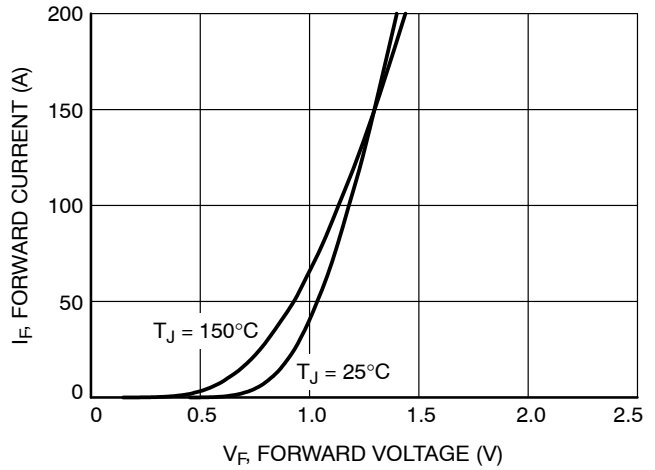

**Figure 4. Diode Forward Characteristic**

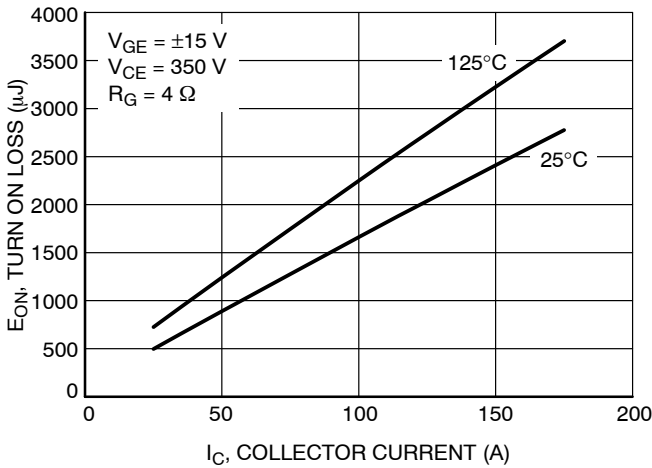

**Figure 5. Typical Turn On Loss vs. IC**

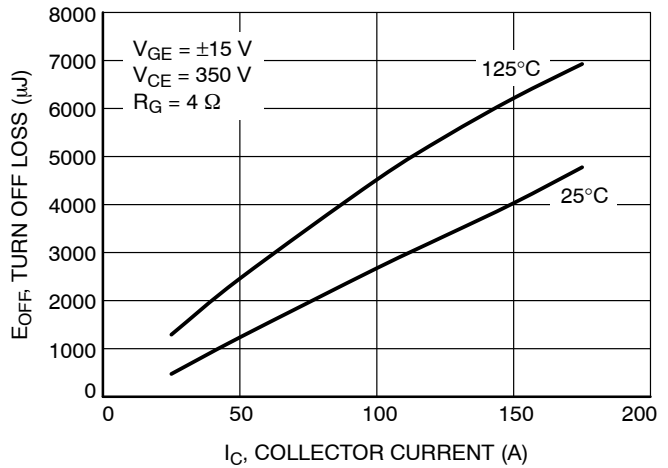

**Figure 6. Typical Turn Off Loss vs. IC**

# NXH160T120L2Q2F2S1G

## TYPICAL CHARACTERISTICS – Half Bridge IGBT and Neutral Point Diode

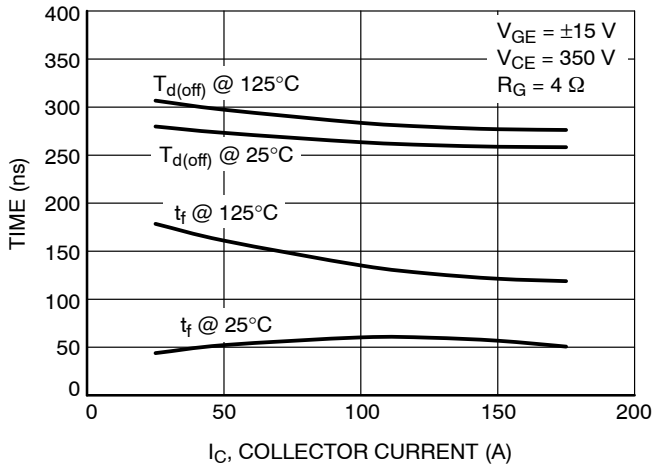

Figure 7. Typical Turn Off Time vs.  $I_C$

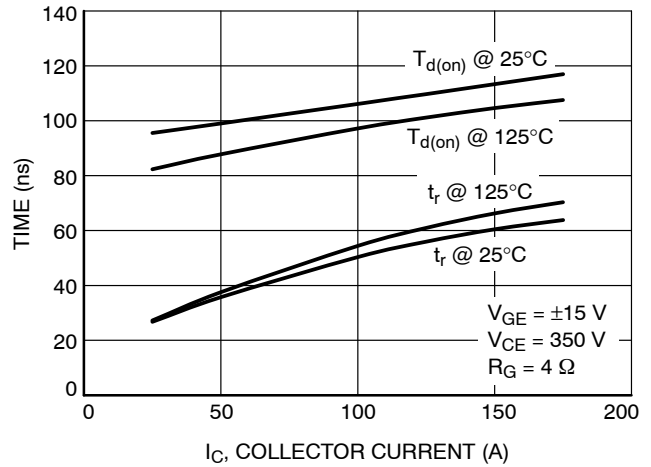

Figure 8. Typical Turn On Time vs.  $I_C$

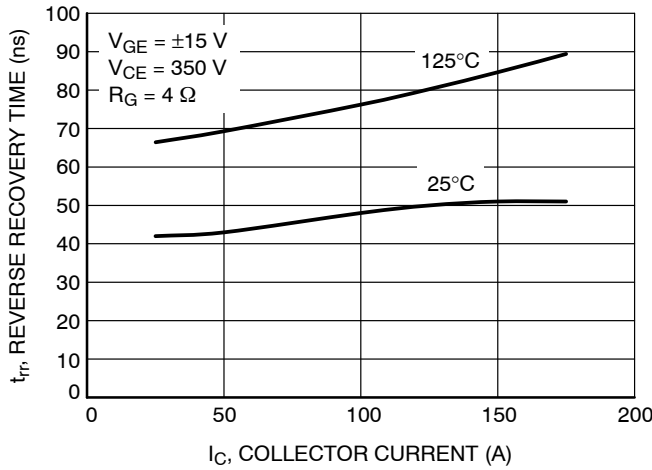

Figure 9. Typical Reverse Recovery Time vs.  $I_C$

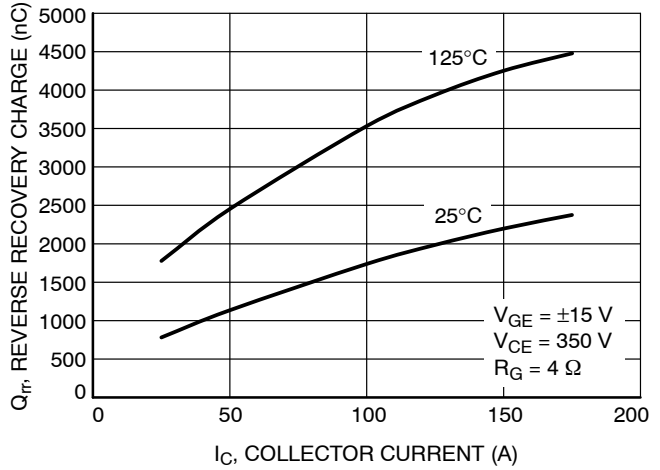

Figure 10. Typical Reverse Recovery Charge vs.  $I_C$

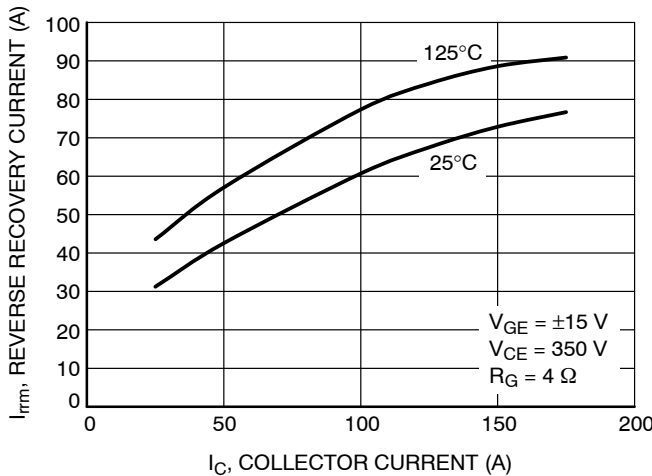

Figure 11. Typical Reverse Recovery Peak Current vs.  $I_C$

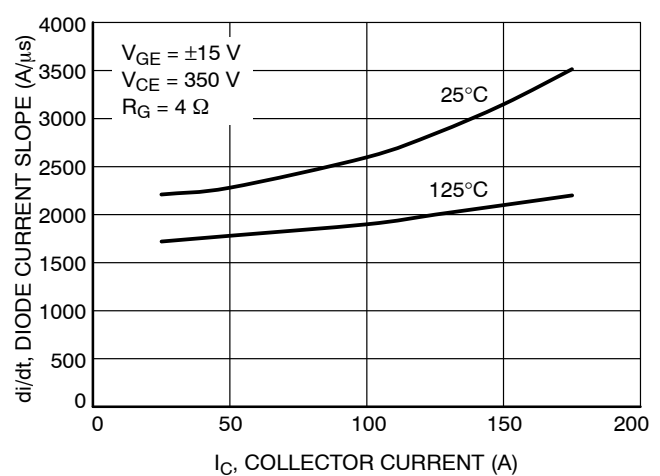
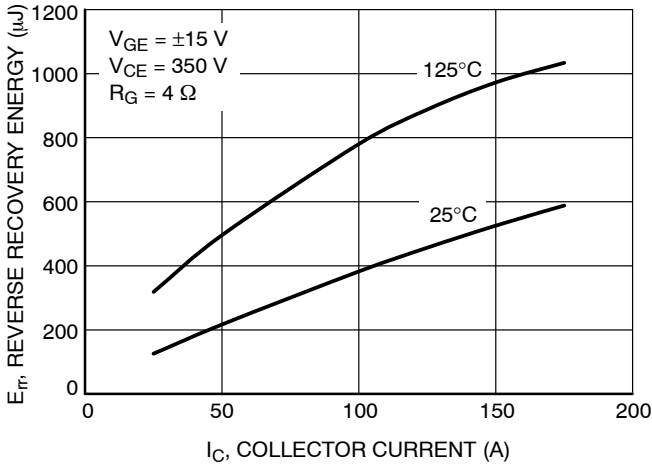

Figure 12. Typical Diode Current Slope vs.  $I_C$

# NXH160T120L2Q2F2S1G

## TYPICAL CHARACTERISTICS – Half Bridge IGBT and Neutral Point Diode



**Figure 13. Typical Reverse Recovery Energy vs.  $I_C$**

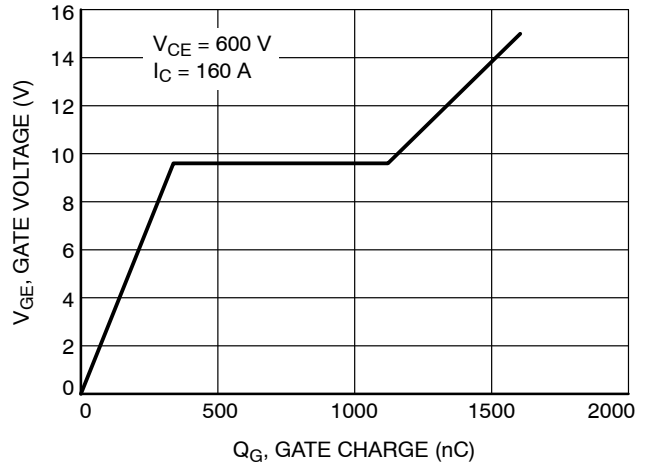

**Figure 14. Gate Voltage vs. Gate Charge**

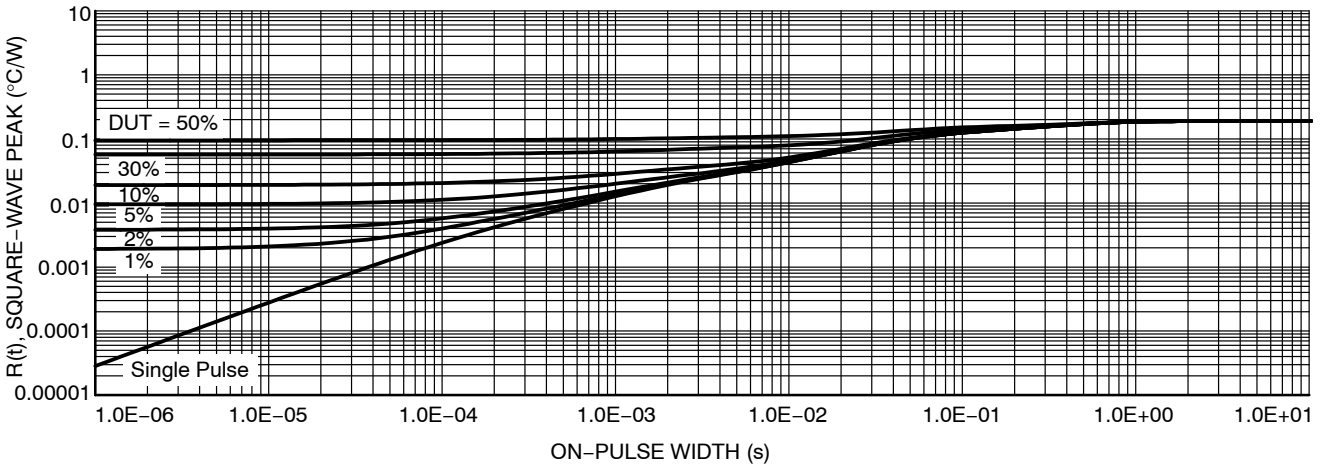

**Figure 15. IGBT Transient Thermal Impedance**

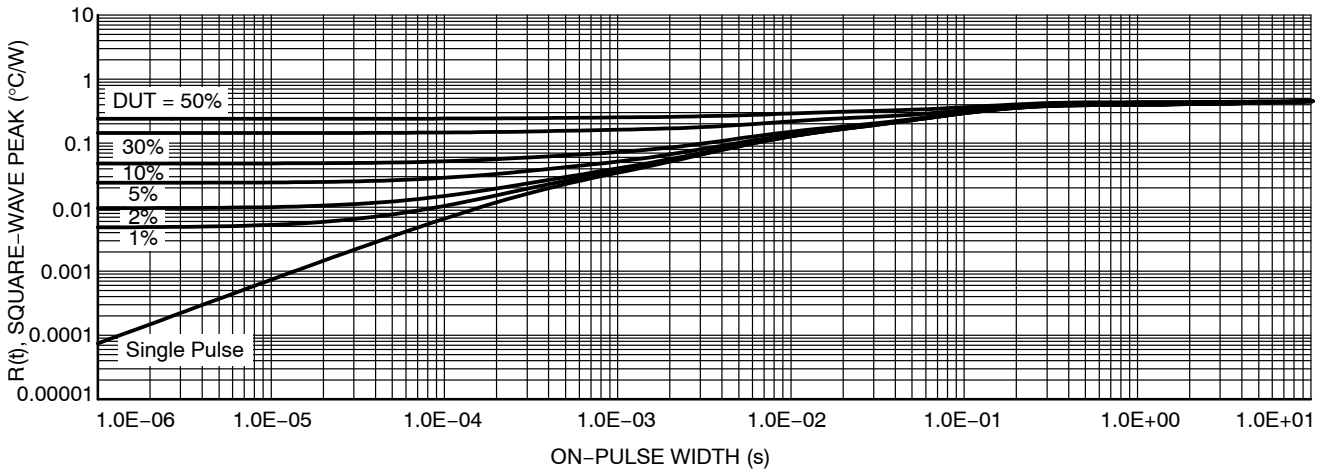
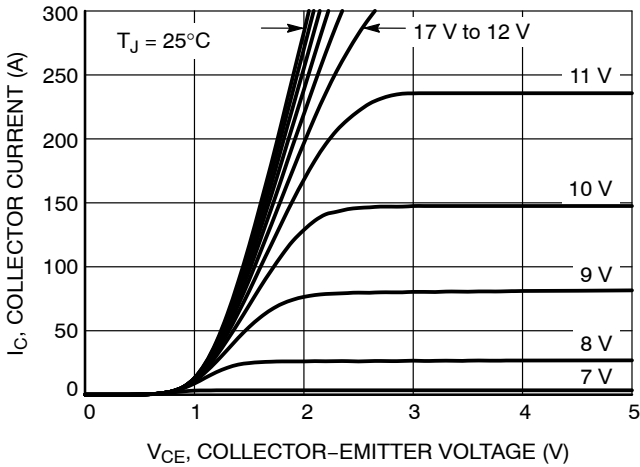

**Figure 16. Diode Transient Thermal Impedance**



# NXH160T120L2Q2F2S1G

## TYPICAL CHARACTERISTICS – Neutral Point IGBT and Half Bridge Diode



**Figure 17. IGBT Typical Output Characteristics**

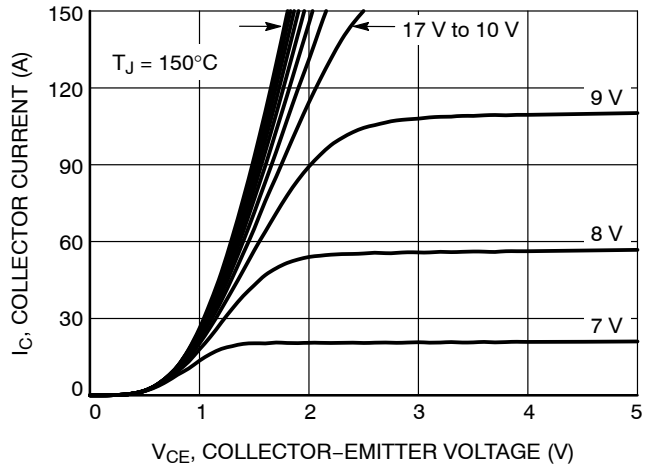

**Figure 18. IGBT Typical Output Characteristics**

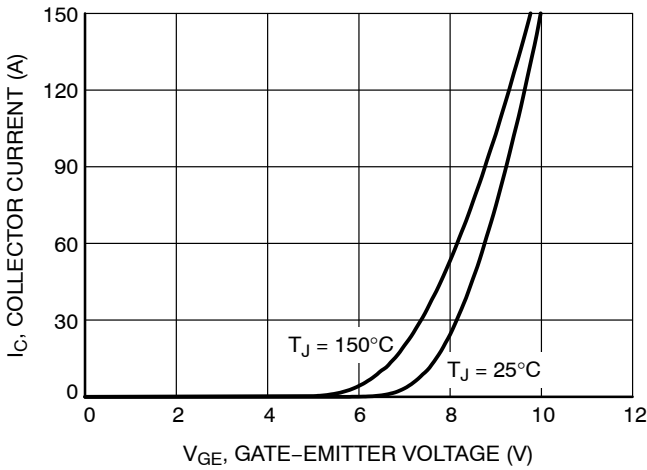

**Figure 19. IGBT Typical Transfer Characteristics**

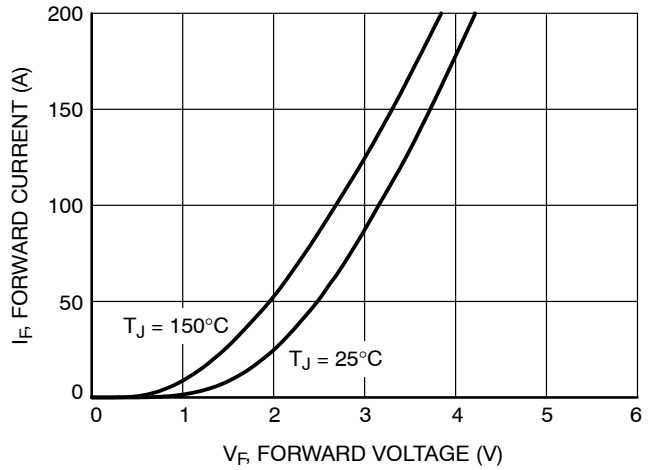

**Figure 20. Diode Forward Characteristic**

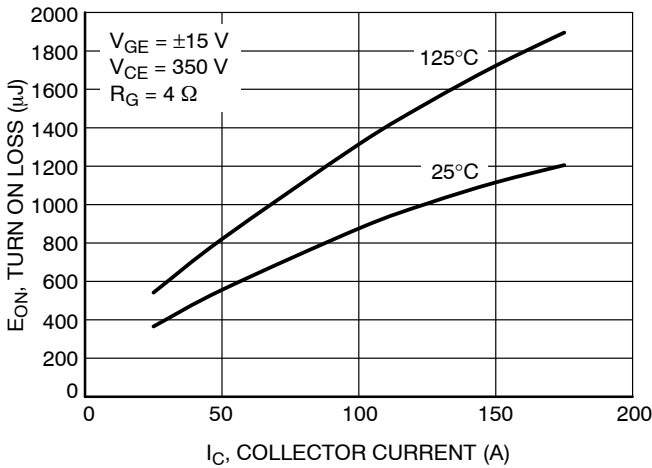

**Figure 21. Typical Turn On Loss vs. Ic**

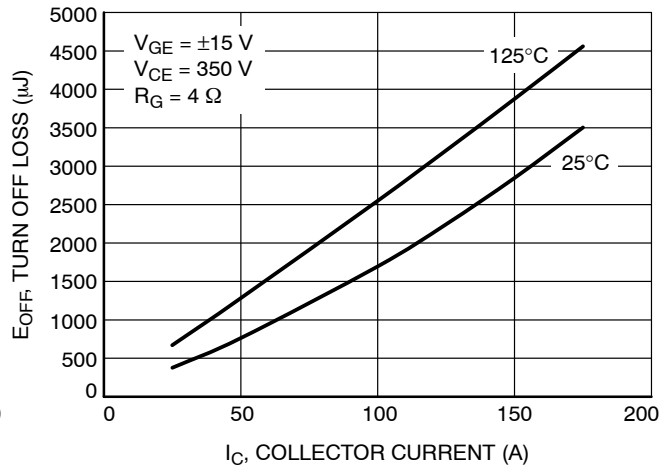

**Figure 22. Typical Turn Off Loss vs. Ic**

# NXH160T120L2Q2F2S1G

## TYPICAL CHARACTERISTICS – Neutral Point IGBT and Half Bridge Diode

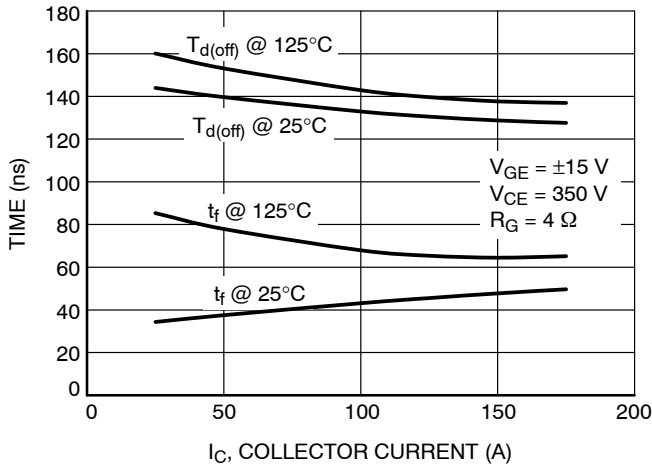

**Figure 23. Typical Turn Off Time vs. IC**

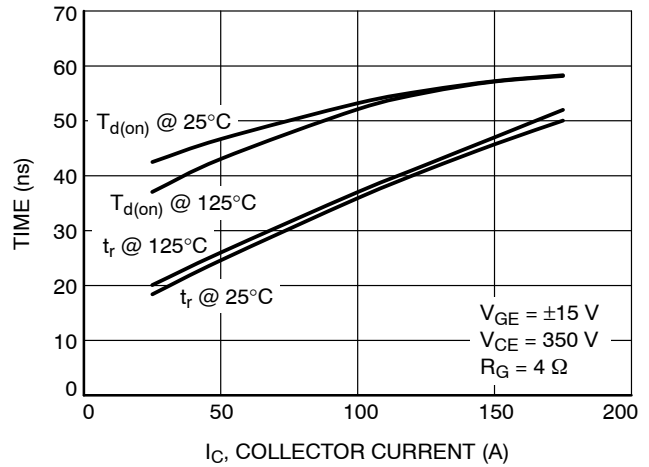

**Figure 24. Typical Turn On Time vs. IC**

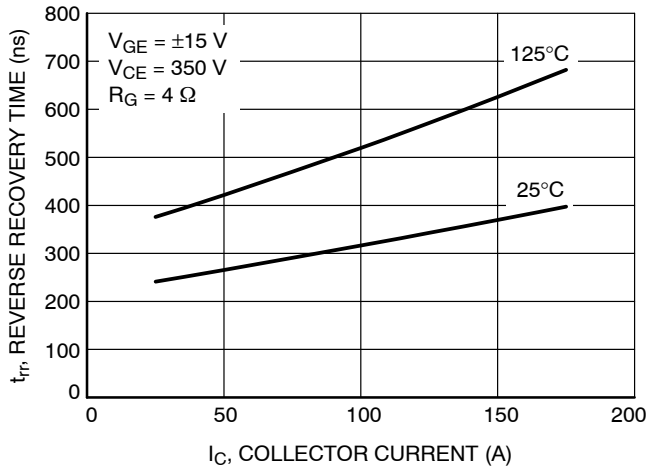

**Figure 25. Typical Reverse Recovery Time vs. IC**

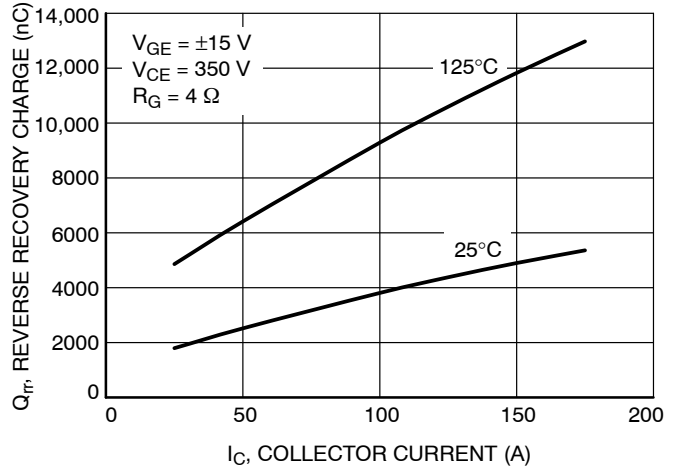

**Figure 26. Typical Reverse Recovery Charge vs. IC**

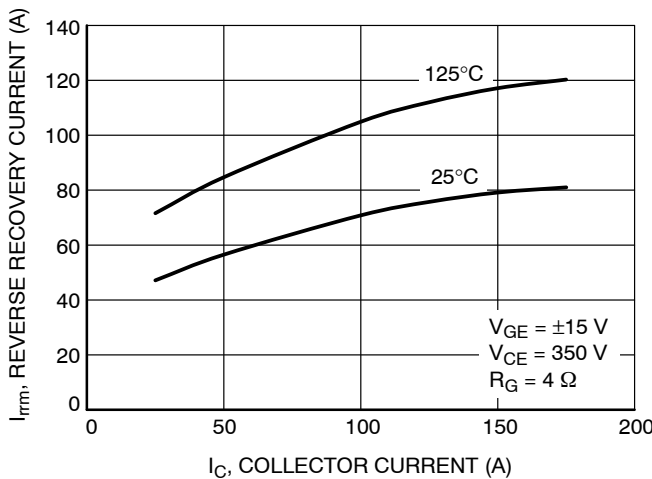

**Figure 27. Typical Reverse Recovery Peak Current vs. IC**

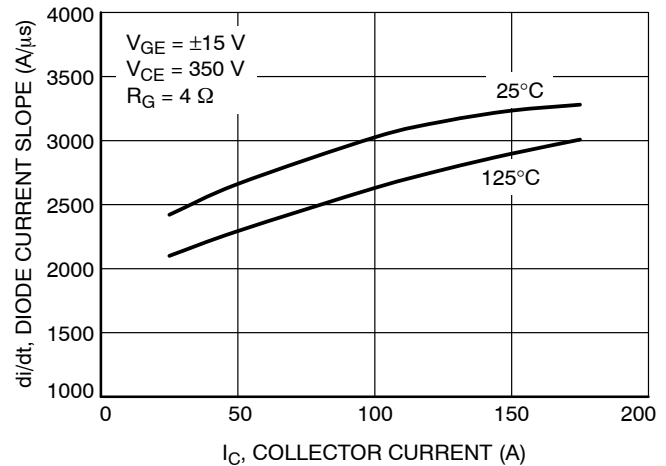

**Figure 28. Typical Diode Current Slope vs. IC**

# NXH160T120L2Q2F2S1G

## TYPICAL CHARACTERISTICS – Neutral Point IGBT and Half Bridge Diode

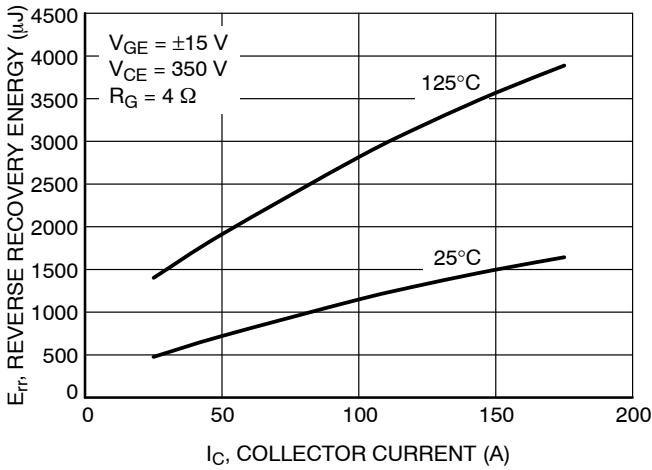

**Figure 29. Typical Reverse Recovery Energy vs.  $I_C$**

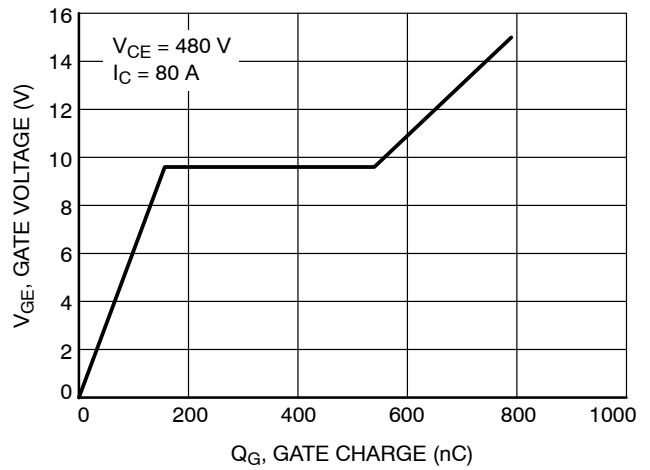

**Figure 30. Gate Voltage vs. Gate Charge**

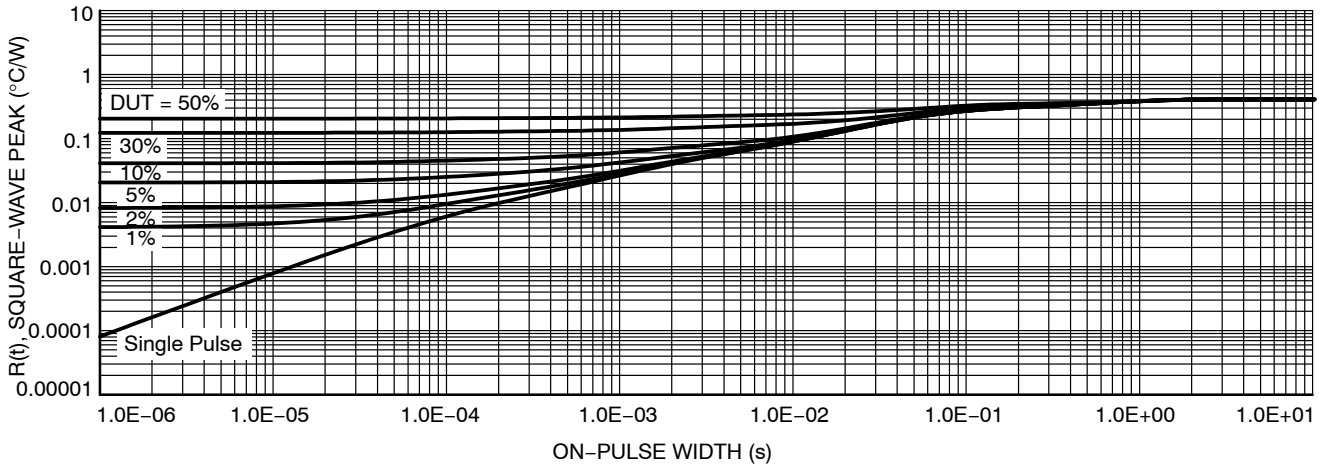

**Figure 31. IGBT Transient Thermal Impedance**

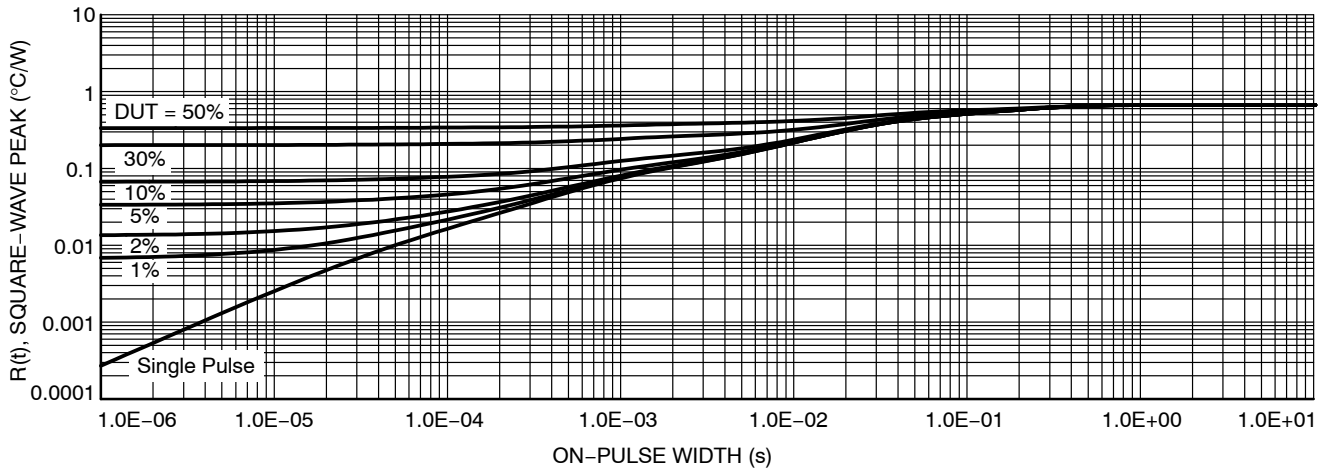

**Figure 32. Diode Transient Thermal Impedance**

# NXH160T120L2Q2F2S1G

## TYPICAL CHARACTERISTICS – Half Bridge IGBT Protection Diode

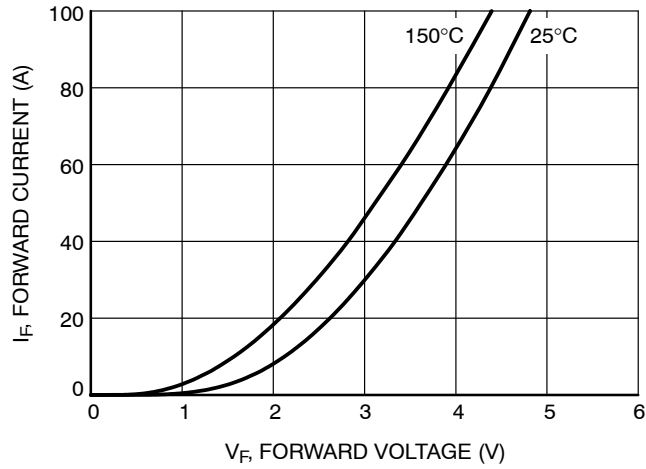

Figure 33. Diode Forward Characteristic

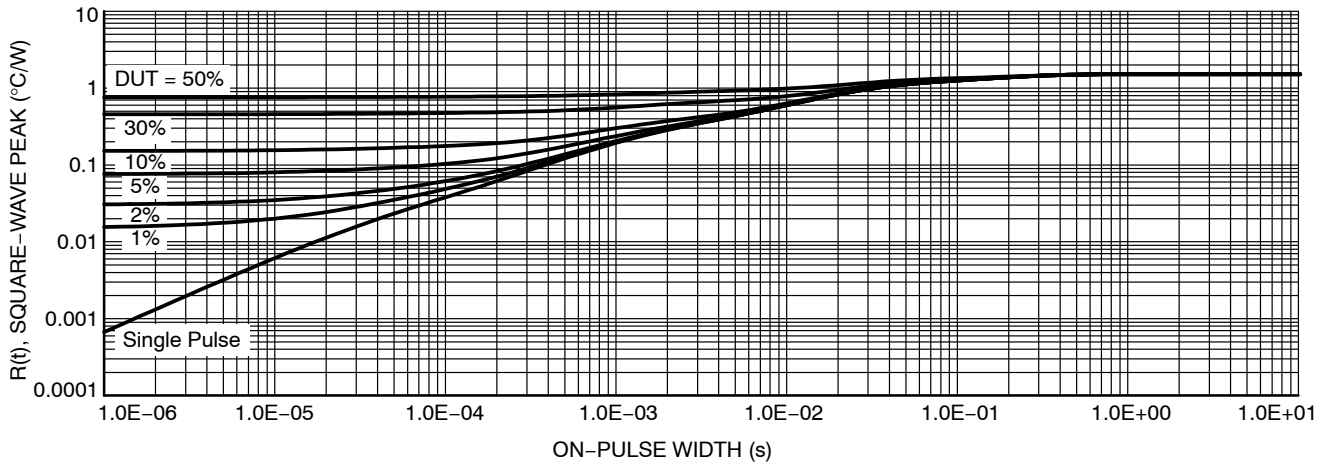

Figure 34. Diode Transient Thermal Impedance

# NXH160T120L2Q2F2S1G

## TYPICAL CHARACTERISTICS – Neutral Point IGBT Protection Diode

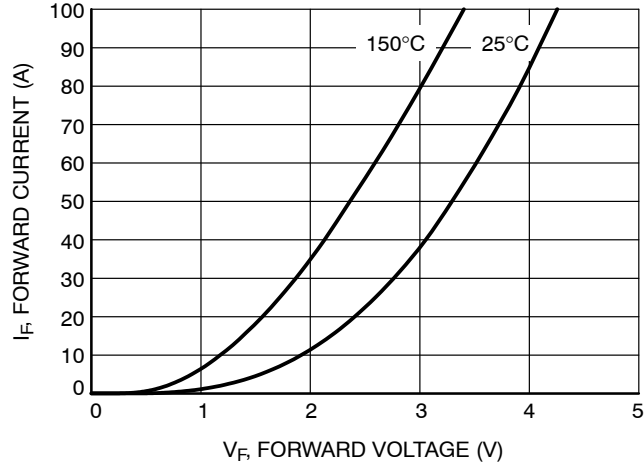

Figure 35. Diode Forward Characteristic

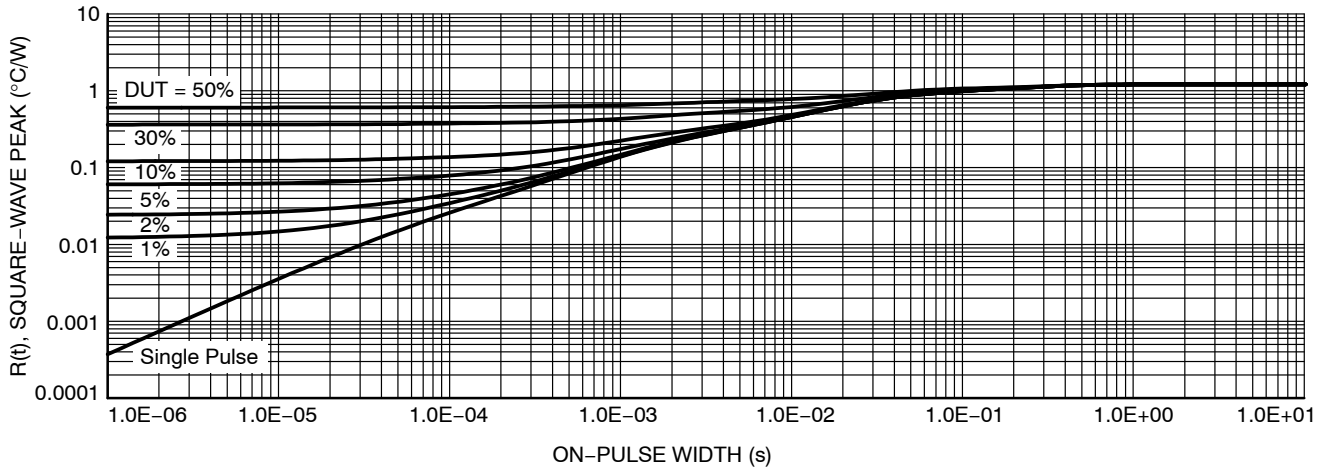

Figure 36. Diode Transient Thermal Impedance

## TYPICAL CHARACTERISTICS – Thermistor

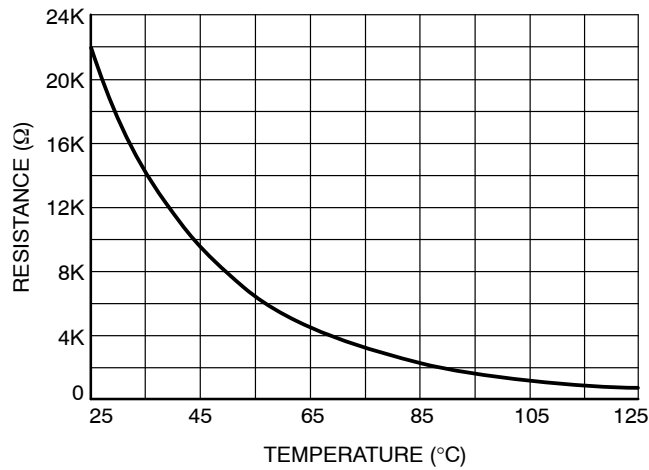
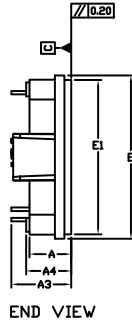
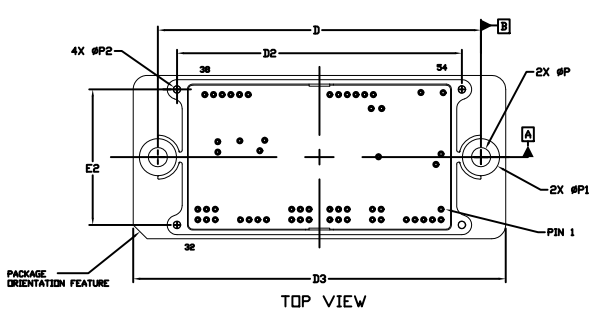

Figure 37. Thermistor Characteristics

# NXH160T120L2Q2F2S1G

## PACKAGE DIMENSIONS

### PIM56, 93x47 (SOLDER PIN) CASE 180AK ISSUE B



**NOTES:**

1. DIMENSIONING AND TOLERANCING PER ASME Y14.5M, 2009.
2. CONTROLLING DIMENSION= MILLIMETERS
3. DIMENSIONS b APPLIES TO THE PLATED TERMINALS AND IS MEASURED BETWEEN 1.00 AND 3.00 FROM THE TERMINAL TIP.
4. POSITION OF THE CENTER OF THE TERMINALS IS DETERMINED FROM DATUM B THE CENTER OF DIMENSION D, X DIRECTION, AND FROM DATUM A, Y DIRECTION. POSITIONAL TOLERANCE, AS NOTED IN DRAWING, APPLIES TO EACH TERMINAL IN BOTH DIRECTIONS.
5. PACKAGE MARKING IS LOCATED AS SHOWN ON THE SIDE WITH THE PACKAGE ORIENTATION FEATURE.

		MILLIMETERS	
DIM		MIN.	MAX.
A		11.80	12.20
A1		4.50	4.90
A2		16.50	16.90
A3		16.70	17.70
A4		12.80	13.20
b		0.95	1.05
D		92.80	93.20
D1		104.60	104.90
D2		81.80	82.20
D3		106.90	107.50
E		46.75	47.25
E1		44.30	44.50
E2		38.80	39.20
P		5.40	5.60
P1		10.60	10.80
P2		2.20	2.40

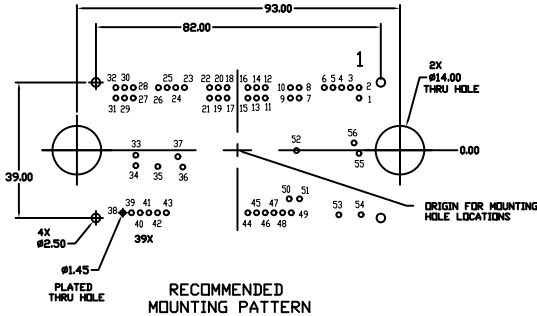
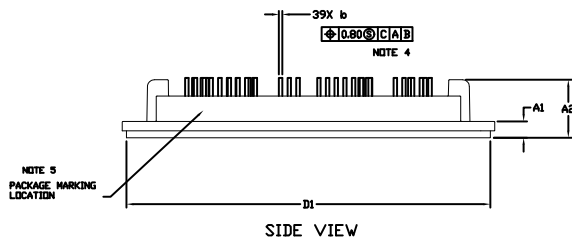

**NOTE 4**

PIN	PIN POSITION		PIN	PIN POSITION	
	X	Y		X	Y
1	35.00	-15.00	29	-32.50	-15.00
2	35.00	-18.00	30	-32.50	-18.00
3	32.50	-18.00	31	-35.00	-15.00
4	30.00	-18.00	32	-35.00	-18.00
5	27.50	-18.00	33	-29.25	1.45
6	25.00	-18.00	34	-29.25	4.45
7	17.75	-15.00	35	-22.90	4.70
8	17.75	-18.00	36	-15.75	4.85
9	15.25	-15.00	37	-17.15	1.85
10	15.25	-18.00	38	-33.00	18.00
11	8.00	-15.00	39	-30.50	18.00
12	8.00	-18.00	40	-28.00	18.00
13	5.50	-15.00	41	-25.50	18.00
14	5.50	-18.00	42	-23.00	18.00
15	3.00	-15.00	43	-20.50	18.00
16	3.00	-18.00	44	3.00	18.00
17	-3.00	-15.00	45	5.50	18.00
18	-3.00	-18.00	46	8.00	18.00
19	-5.50	-15.00	47	10.50	18.00
20	-5.50	-18.00	48	13.00	18.00
21	-8.00	-15.00	49	15.50	18.00
22	-8.00	-18.00	50	14.90	14.00
23	-15.25	-18.00	51	17.90	14.00
24	-17.75	-18.00	52	17.00	0.10
25	-20.25	-18.00	53	29.20	18.60
26	-22.75	-18.00	54	35.60	18.55
27	-30.00	-15.00	55	35.00	0.90
28	-30.00	-18.00	56	33.55	-2.10

**MOUNTING HOLE POSITION**

PIN	PIN POSITION		PIN	PIN POSITION	
	X	Y		X	Y
1	35.00	15.00	29	-32.50	15.00
2	35.00	18.00	30	-32.50	18.00
3	32.50	18.00	31	-35.00	15.00
4	30.00	18.00	32	-35.00	18.00
5	27.50	18.00	33	-29.25	-1.45
6	25.00	18.00	34	-29.25	-4.45
7	17.75	15.00	35	-22.90	-4.70
8	17.75	18.00	36	-15.75	-4.85
9	15.25	15.00	37	-17.15	-1.85
10	15.25	18.00	38	-33.00	-18.00
11	8.00	15.00	39	-30.50	-18.00
12	8.00	18.00	40	-28.00	-18.00
13	5.50	15.00	41	-25.50	-18.00
14	5.50	18.00	42	-23.00	-18.00
15	3.00	15.00	43	-20.50	-18.00
16	3.00	18.00	44	3.00	-18.00
17	-3.00	15.00	45	5.50	-18.00
18	-3.00	18.00	46	8.00	-18.00
19	-5.50	15.00	47	10.50	-18.00
20	-5.50	18.00	48	13.00	-18.00
21	-8.00	15.00	49	15.50	-18.00
22	-8.00	18.00	50	14.90	-14.00
23	-15.25	18.00	51	17.90	-14.00
24	-17.75	18.00	52	17.00	-0.10
25	-20.25	18.00	53	29.20	-18.60
26	-22.75	18.00	54	35.60	-18.55
27	-30.00	15.00	55	35.00	-0.90
28	-30.00	18.00	56	33.55	2.10

ON Semiconductor and are trademarks of Semiconductor Components Industries, LLC dba ON Semiconductor or its subsidiaries in the United States and/or other countries. ON Semiconductor owns the rights to a number of patents, trademarks, copyrights, trade secrets, and other intellectual property. A listing of ON Semiconductor's product/patent coverage may be accessed at [www.onsemi.com/site/pdf/Patent-Marketing.pdf](http://www.onsemi.com/site/pdf/Patent-Marketing.pdf). ON Semiconductor reserves the right to make changes without further notice to any products herein. ON Semiconductor makes no warranty, representation or guarantee regarding the suitability of its products for any particular purpose, nor does ON Semiconductor assume any liability arising out of the application or use of any product or circuit, and specifically disclaims any and all liability, including without limitation special, consequential or incidental damages. Buyer is responsible for its products and applications using ON Semiconductor products, including compliance with all laws, regulations and safety requirements or standards, regardless of any support or applications information provided by ON Semiconductor. "Typical" parameters which may be provided in ON Semiconductor data sheets and/or specifications can and do vary in different applications and actual performance may vary over time. All operating parameters, including "Typicals" must be validated for each customer application by customer's technical experts. ON Semiconductor does not convey any license under its patent rights nor the rights of others. ON Semiconductor products are not designed, intended, or authorized for use as a critical component in life support systems or any FDA Class 3 medical devices or medical devices with a same or similar classification in a foreign jurisdiction or any devices intended for implantation in the human body. Should Buyer purchase or use ON Semiconductor products for any such unintended or unauthorized application, Buyer shall indemnify and hold ON Semiconductor and its officers, employees, subsidiaries, affiliates, and distributors harmless against all claims, costs, damages, and expenses, and reasonable attorney fees arising out of, directly or indirectly, any claim of personal injury or death associated with such unintended or unauthorized use, even if such claim alleges that ON Semiconductor was negligent regarding the design or manufacture of the part. ON Semiconductor is an Equal Opportunity/Affirmative Action Employer. This literature is subject to all applicable copyright laws and is not for resale in any manner.

### PUBLICATION ORDERING INFORMATION

**LITERATURE FULFILLMENT:**  
Literature Distribution Center for ON Semiconductor  
19521 E. 32nd Pkwy, Aurora, Colorado 80011 USA  
**Phone:** 303-675-2175 or 800-344-3860 Toll Free USA/Canada  
**Fax:** 303-675-2176 or 800-344-3867 Toll Free USA/Canada  
**Email:** [orderlit@onsemi.com](mailto:orderlit@onsemi.com)

**N. American Technical Support:** 800-282-9855 Toll Free  
USA/Canada  
**Europe, Middle East and Africa Technical Support:**  
Phone: 421 33 790 2910

**ON Semiconductor Website:** [www.onsemi.com](http://www.onsemi.com)  
**Order Literature:** <http://www.onsemi.com/orderlit>

For additional information, please contact your local Sales Representative