

# NXH80B120L2Q0

## Q0 - Dual Boost Power Module

The NXH80B120L2Q0 is a high-density, integrated power module combines high-performance IGBTs with rugged anti-parallel diodes including on-board thermistor.

### Features

- Dual Boost 40 A / 1200 V IGBT and Si FRD Module
- 1200 V FSII IGBT  $V_{CE(SAT)} = 2.2\text{ V}$
- 1200 V Stealth Fast Recovery Diode  $V_F = 2.4\text{ V}$
- Low Inductive Layout
- Solderable Pins
- Thermistor
- Bare Copper and Nickel-Plated DBC Options

### Typical Applications

- Solar Inverter
- Uninterruptible Power Supplies
- Energy Storage Systems

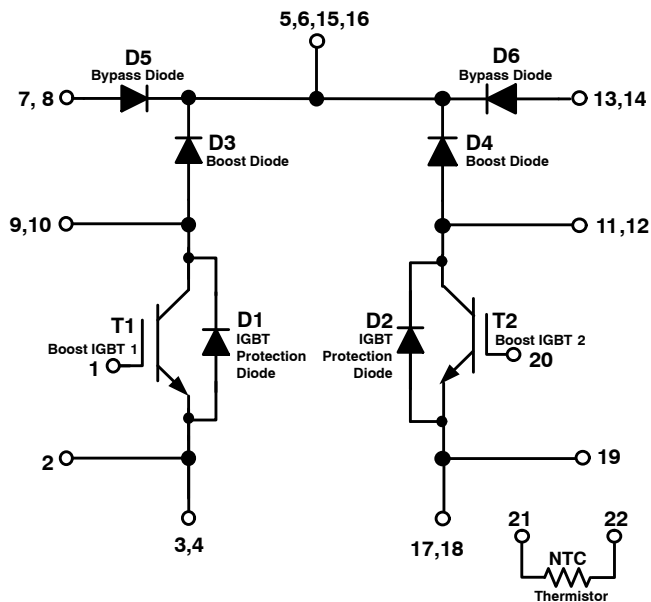
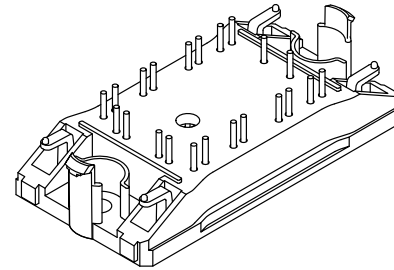

Figure 1. NXH80B120L2Q0SNG Schematic Diagram



**ON Semiconductor®**

[www.onsemi.com](http://www.onsemi.com)



**Q0BOOST  
CASE 180AJ**

### MARKING DIAGRAM

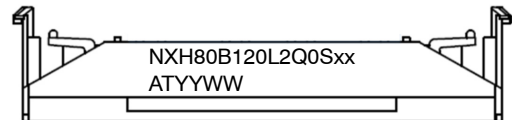

NXH80B120L2Q0Sxx = Specific Device Code  
AT = Assembly & Test Side Code  
YYWW = Year and Work Week Code

### PIN CONNECTIONS

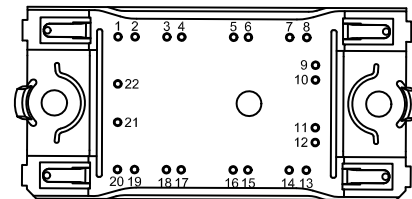

### ORDERING INFORMATION

See detailed ordering, marking and shipping information on page 4 of this data sheet.

# NXH80B120L2Q0

**Table 1. ABSOLUTE MAXIMUM RATINGS** (Note 1)  $T_J = 25^\circ\text{C}$  unless otherwise noted

Rating	Symbol	Value	Unit
<b>BOOST IGBT</b>			
Collector–Emitter Voltage	$V_{CES}$	1200	V
Gate–Emitter Voltage	$V_{GE}$	$\pm 20$	V
Continuous Collector Current @ $T_h = 80^\circ\text{C}$ ( $T_J = 175^\circ\text{C}$ )	$I_C$	41	A
Pulsed Collector Current ( $T_J = 175^\circ\text{C}$ )	$I_{Cpulse}$	123	A
Maximum Power Dissipation ( $T_J = 175^\circ\text{C}$ )	$P_{tot}$	103	W
Short Circuit Withstand Time @ $V_{GE} = 15\text{ V}$ , $V_{CE} = 600\text{ V}$ , $T_J \leq 150^\circ\text{C}$	$T_{sc}$	5	$\mu\text{s}$
Minimum Operating Junction Temperature	$T_{JMIN}$	-40	$^\circ\text{C}$
Maximum Operating Junction Temperature	$T_{JMAX}$	150	$^\circ\text{C}$

<b>BOOST DIODE</b>			
Peak Repetitive Reverse Voltage	$V_{RRM}$	1200	V
Continuous Forward Current @ $T_h = 80^\circ\text{C}$ ( $T_J = 175^\circ\text{C}$ )	$I_F$	25	A
Maximum Power Dissipation ( $T_J = 175^\circ\text{C}$ )	$P_{tot}$	60	W
Surge Forward Current (60 Hz single half–sine wave)	$I_{FSM}$	150	A
$I^2t$ – value (60 Hz single half–sine wave)	$I^2t$	93	$\text{A}^2\text{s}$
Minimum Operating Junction Temperature	$T_{JMIN}$	-40	$^\circ\text{C}$
Maximum Operating Junction Temperature	$T_{JMAX}$	150	$^\circ\text{C}$

<b>BYPASS DIODE / IGBT PROTECTION DIODE</b>			
Peak Repetitive Reverse Voltage	$V_{RRM}$	1600	V
Continuous Forward Current @ $T_c = 80^\circ\text{C}$ ( $T_J = 150^\circ\text{C}$ )	$I_F$	46	A
Repetitive Peak Forward Current ( $T_J = 175^\circ\text{C}$ , $t_p$ limited by $T_{Jmax}$ )	$I_{FRM}$	130	A
Power Dissipation Per Diode ( $T_J = 175^\circ\text{C}$ )	$P_{tot}$	66	W
Minimum Operating Junction Temperature	$T_{JMIN}$	-40	$^\circ\text{C}$
Maximum Operating Junction Temperature	$T_{JMAX}$	150	$^\circ\text{C}$

### THERMAL PROPERTIES

Storage Temperature range	$T_{stg}$	-40 to 125	$^\circ\text{C}$
---------------------------	-----------	------------	------------------

### INSULATION PROPERTIES

Isolation test voltage, $t = 1\text{ sec}$ , 60 Hz	$V_{is}$	3000	$V_{RMS}$
Creepage distance		12.7	mm

Stresses exceeding those listed in the Maximum Ratings table may damage the device. If any of these limits are exceeded, device functionality should not be assumed, damage may occur and reliability may be affected.

1. Refer to ELECTRICAL CHARACTERISTICS, RECOMMENDED OPERATING RANGES and/or APPLICATION INFORMATION for Safe Operating parameters.

**Table 2. RECOMMENDED OPERATING RANGES**

Rating	Symbol	Min	Max	Unit
Module Operating Junction Temperature	$T_J$	-40	( $T_{Jmax} - 25$ )	$^\circ\text{C}$

Functional operation above the stresses listed in the Recommended Operating Ranges is not implied. Extended exposure to stresses beyond the Recommended Operating Ranges limits may affect device reliability.

# NXH80B120L2Q0

**Table 3. ELECTRICAL CHARACTERISTICS**  $T_J = 25^\circ\text{C}$  unless otherwise noted

Parameter	Test Conditions	Symbol	Min	Typ	Max	Unit
<b>BOOST IGBT CHARACTERISTICS</b>						
Collector-Emitter Cutoff Current	$V_{GE} = 0\text{ V}, V_{CE} = 1200\text{ V}$	$I_{CES}$	–	–	200	$\mu\text{A}$
Collector-Emitter Saturation Voltage	$V_{GE} = 15\text{ V}, I_C = 40\text{ A}, T_J = 25^\circ\text{C}$	$V_{CE(sat)}$	–	2.20	2.5	V
	$V_{GE} = 15\text{ V}, I_C = 40\text{ A}, T_J = 150^\circ\text{C}$		–	2.16	–	
Gate-Emitter Threshold Voltage	$V_{GE} = V_{CE}, I_C = 1.5\text{ mA}$	$V_{GE(TH)}$	–	5.45	6.4	V
Gate Leakage Current	$V_{GE} = 20\text{ V}, V_{CE} = 0\text{ V}$	$I_{GES}$	–	–	200	nA
Turn-on Delay Time	$T_J = 25^\circ\text{C}$ $V_{CE} = 700\text{ V}, I_C = 40\text{ A}$ $V_{GE} = \pm 15\text{ V}, R_G = 4\ \Omega$	$t_{d(on)}$	–	27	–	ns
Rise Time		$t_r$	–	20	–	
Turn-off Delay Time		$t_{d(off)}$	–	95	–	
Fall Time		$t_f$	–	75	–	
Turn-on Switching Loss per Pulse		$E_{on}$	–	1020	–	
Turn off Switching Loss per Pulse	$E_{off}$	–	1810	–		
Turn-on Delay Time	$T_J = 125^\circ\text{C}$ $V_{CE} = 700\text{ V}, I_C = 40\text{ A}$ $V_{GE} = \pm 15\text{ V}, R_G = 4\ \Omega$	$t_{d(on)}$	–	27	–	ns
Rise Time		$t_r$	–	20	–	
Turn-off Delay Time		$t_{d(off)}$	–	110	–	
Fall Time		$t_f$	–	180	–	
Turn-on Switching Loss per Pulse		$E_{on}$	–	1630	–	
Turn off Switching Loss per Pulse	$E_{off}$	–	3550	–		
Input Capacitance	$V_{CE} = 25\text{ V}, V_{GE} = 0\text{ V}, f = 10\text{ kHz}$	$C_{ies}$	–	9700	–	pF
Output Capacitance		$C_{oes}$	–	200	–	
Reverse Transfer Capacitance		$C_{res}$	–	170	–	
Total Gate Charge	$V_{CE} = 600\text{ V}, I_C = 40\text{ A}, V_{GE} = 15\text{ V}$	$Q_g$	–	400	–	nC
Thermal Resistance – chip-to-heatsink	Thermal grease, Thickness < 100 $\mu\text{m}$ , $\lambda = 0.84\text{ W/mK}$	$R_{thJH}$	–	0.92	–	$^\circ\text{C/W}$

### BOOST DIODE CHARACTERISTICS

Diode Reverse Leakage Current	$V_R = 1200\text{ V}$	$I_R$	–	–	100	$\mu\text{A}$
Diode Forward Voltage	$I_F = 30\text{ A}, T_J = 25^\circ\text{C}$	$V_F$	–	2.4	3.15	V
	$I_F = 30\text{ A}, T_J = 150^\circ\text{C}$		–	1.9	–	
Reverse Recovery Time	$T_J = 25^\circ\text{C}$ $V_{CE} = 700\text{ V}, I_C = 40\text{ A}$ $V_{GE} = \pm 15\text{ V}, R_G = 4\ \Omega$	$t_{rr}$	–	195	–	ns
Reverse Recovery Charge		$Q_{rr}$	–	2420	–	nC
Peak Reverse Recovery Current		$I_{RRM}$	–	53	–	A
Peak Rate of Fall of Recovery Current		$di/dt$	–	2390	–	A/ $\mu\text{s}$
Reverse Recovery Energy		$E_{rr}$	–	1360	–	$\mu\text{J}$
Reverse Recovery Time	$T_J = 125^\circ\text{C}$ $V_{CE} = 700\text{ V}, I_C = 40\text{ A}$ $V_{GE} = \pm 15\text{ V}, R_G = 4\ \Omega$	$t_{rr}$	–	370	–	ns
Reverse Recovery Charge		$Q_{rr}$	–	5580	–	nC
Peak Reverse Recovery Current		$I_{RRM}$	–	75	–	A
Peak Rate of Fall of Recovery Current		$di/dt$	–	2025	–	A/ $\mu\text{s}$
Reverse Recovery Energy		$E_{rr}$	–	3160	–	$\mu\text{J}$
Thermal Resistance – chip-to-heatsink	Thermal grease, Thickness < 100 $\mu\text{m}$ , $\lambda = 0.84\text{ W/mK}$	$R_{thJH}$	–	1.59	–	$^\circ\text{C/W}$

### BYPASS DIODE/IGBT PROTECTION DIODE CHARACTERISTICS

Diode Reverse Leakage Current	$V_R = 1600\text{ V}, T_J = 25^\circ\text{C}$	$I_R$	–	–	100	$\mu\text{A}$
-------------------------------	---	-------	---	---	-----	---------------

# NXH80B120L2Q0

**Table 3. ELECTRICAL CHARACTERISTICS**  $T_J = 25^\circ\text{C}$  unless otherwise noted

Parameter	Test Conditions	Symbol	Min	Typ	Max	Unit
<b>BYPASS DIODE/IGBT PROTECTION DIODE CHARACTERISTICS</b>						
Diode Forward Voltage	$I_F = 25\text{ A}, T_J = 25^\circ\text{C}$	$V_F$	–	1.0	1.4	V
	$I_F = 25\text{ A}, T_J = 150^\circ\text{C}$		–	0.90	–	
Thermal Resistance – chip-to-heatsink	Thermal grease, Thickness < 100 $\mu\text{m}$ , $\lambda = 0.84\text{ W/mK}$	$R_{thJH}$	–	1.44	–	$^\circ\text{C/W}$

**THERMISTOR CHARACTERISTICS**

Nominal resistance		$R_{25}$	–	22	–	$\text{k}\Omega$
Nominal resistance	$T = 100^\circ\text{C}$	$R_{100}$	–	1486	–	$\Omega$
Deviation of R25		$\Delta R/R$	–5	–	5	%
Power dissipation		$P_D$	–	200	–	mW
Power dissipation constant			–	2	–	mW/K
B-value	B(25/50), tolerance $\pm 3\%$		–	3950	–	K
B-value	B(25/100), tolerance $\pm 3\%$		–	3998	–	K

Product parametric performance is indicated in the Electrical Characteristics for the listed test conditions, unless otherwise noted. Product performance may not be indicated by the Electrical Characteristics if operated under different conditions.

**ORDERING INFORMATION**

Orderable Part Number	Marking	Package	Shipping
NXH80B120L2Q0SG	NXH80B120L2Q0SG	Q0BOOST – Case 180AJ Bare Copper DBC, Solder Pins (Pb-Free and Halide-Free)	24 Units / Blister Tray
NXH80B120L2Q0SNG	NXH80B120L2Q0SNG	Q0BOOST – Case 180AJ Nickel-Plated DBC, Solder Pins (Pb-Free and Halide-Free)	24 Units / Blister Tray

# NXH80B120L2Q0

## TYPICAL CHARACTERISTICS – Boost IGBT & Boost Diode

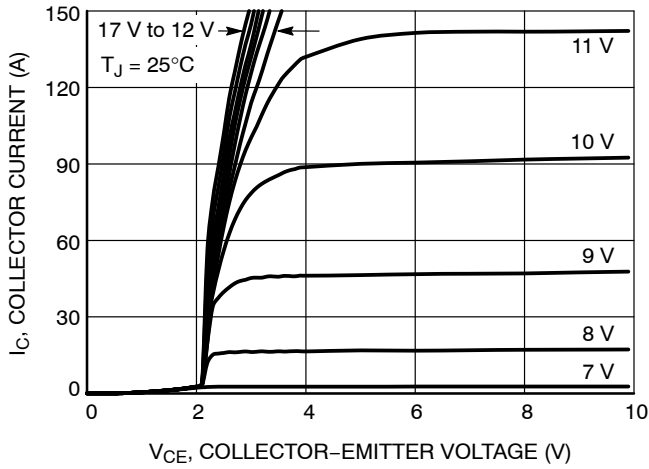

Figure 1. IGBT Typical Output Characteristics

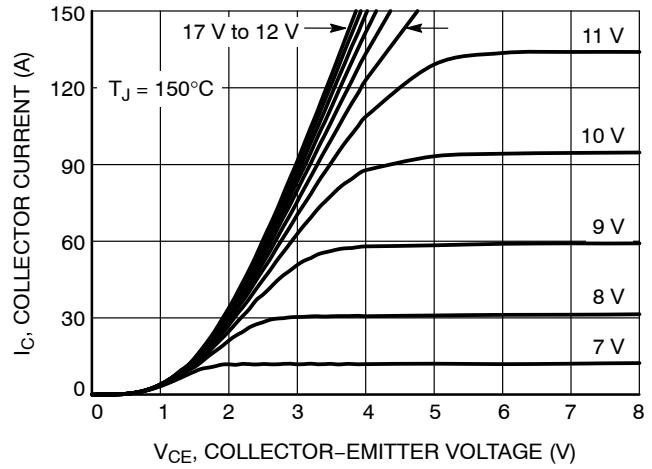

Figure 2. IGBT Typical Output Characteristics

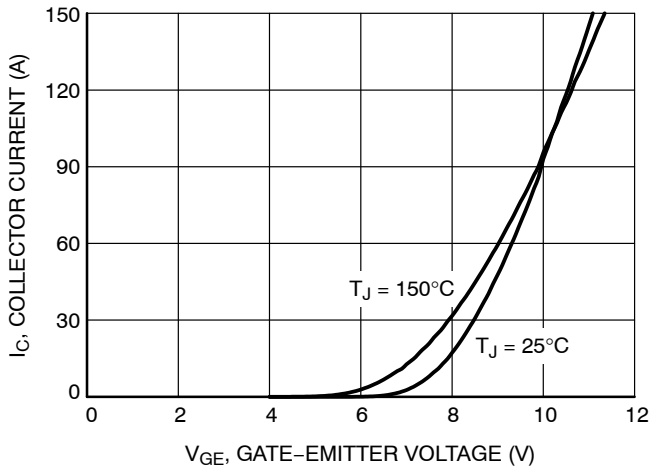

Figure 3. IGBT Typical Transfer Characteristics

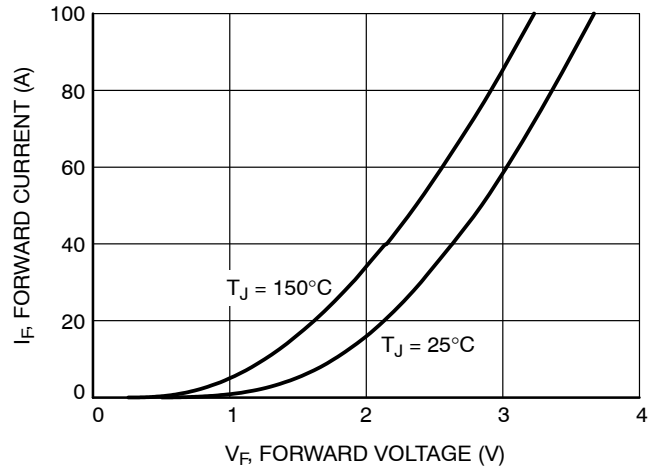

Figure 4. Diode Forward Characteristic

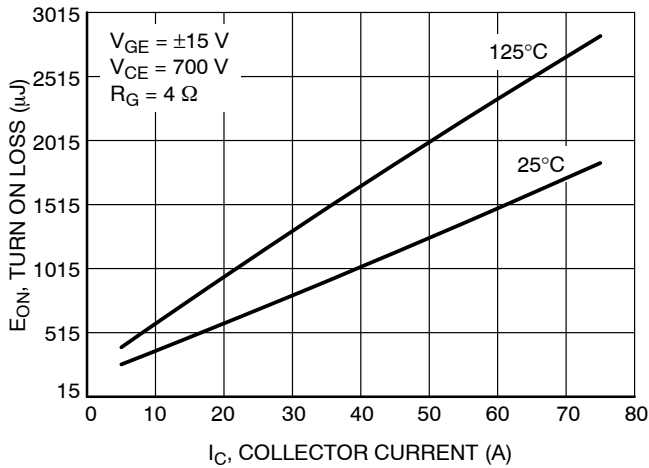

Figure 5. Typical Turn On Loss vs. Ic

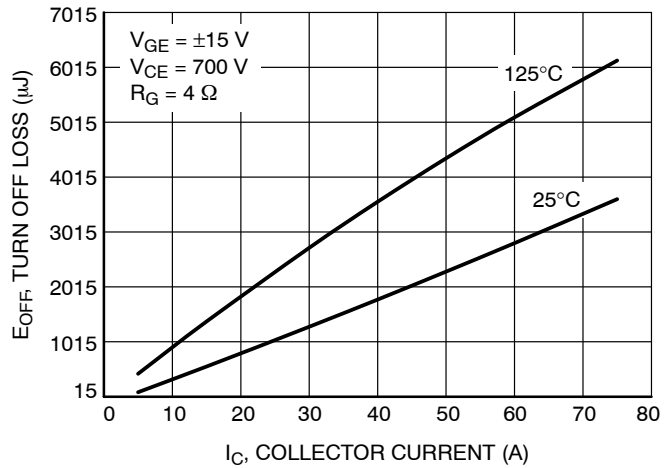

Figure 6. Typical Turn Off Loss vs. Ic

# NXH80B120L2Q0

## TYPICAL CHARACTERISTICS – Boost IGBT & Boost Diode

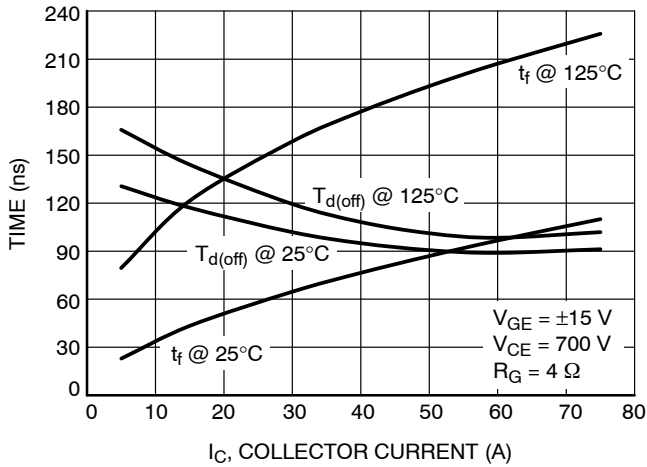

Figure 7. Typical Switching Times vs. IC

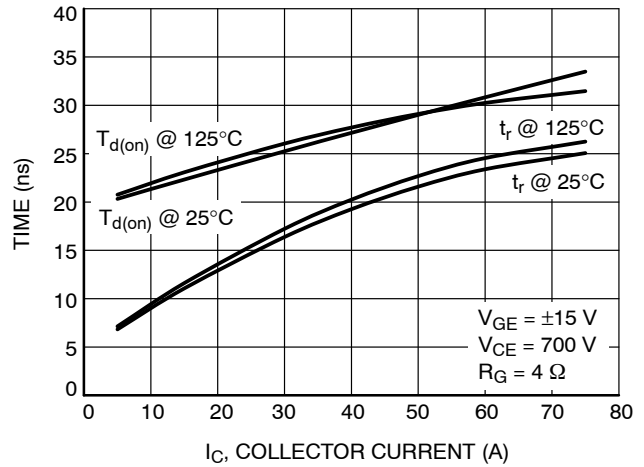

Figure 8. Typical Switching Times vs. IC

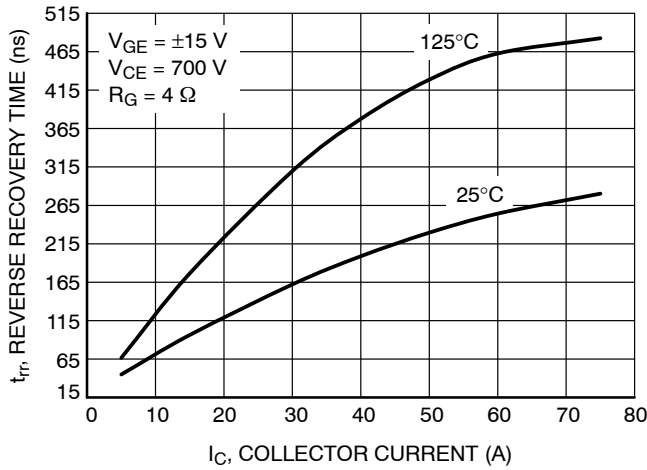

Figure 9. Typical Reverse Recovery Time vs. IC

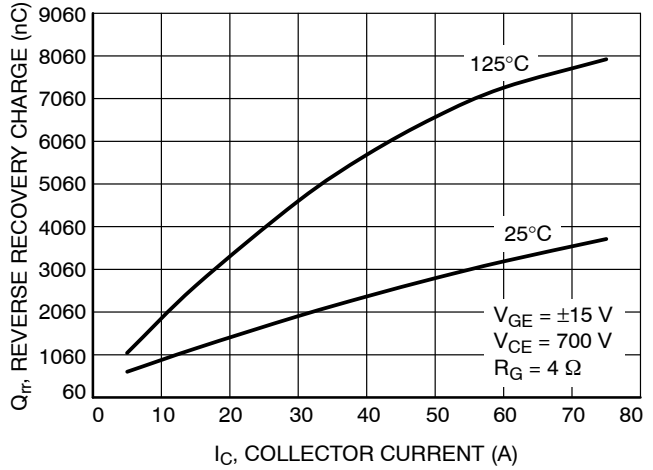

Figure 10. Typical Reverse Recovery Charge vs. IC

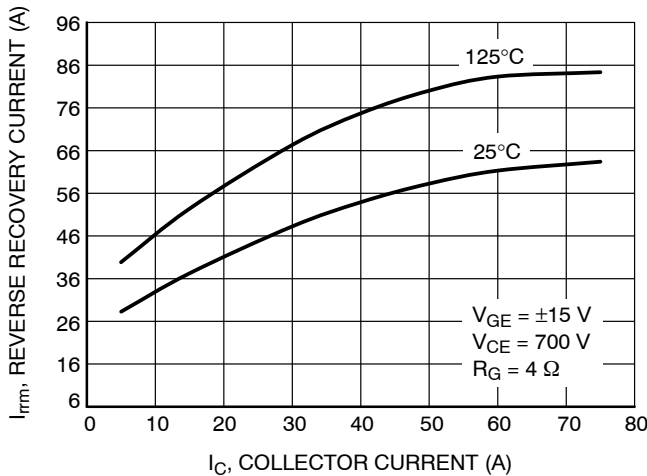

Figure 11. Typical Reverse Recovery Peak Current vs. IC

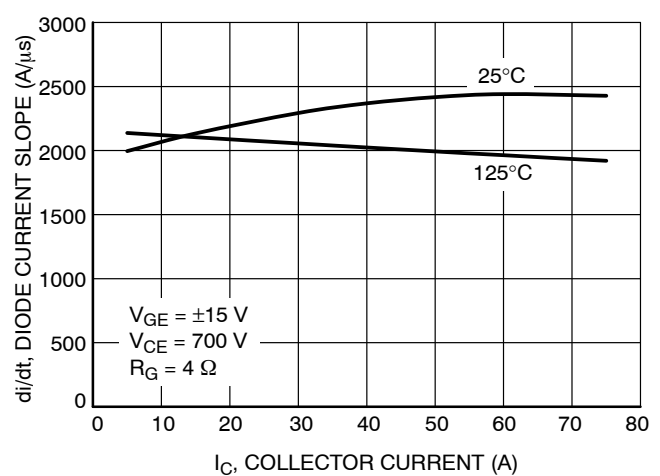

Figure 12. Typical Diode Current Slope vs. IC

# NXH80B120L2Q0

## TYPICAL CHARACTERISTICS – Boost IGBT & Boost Diode

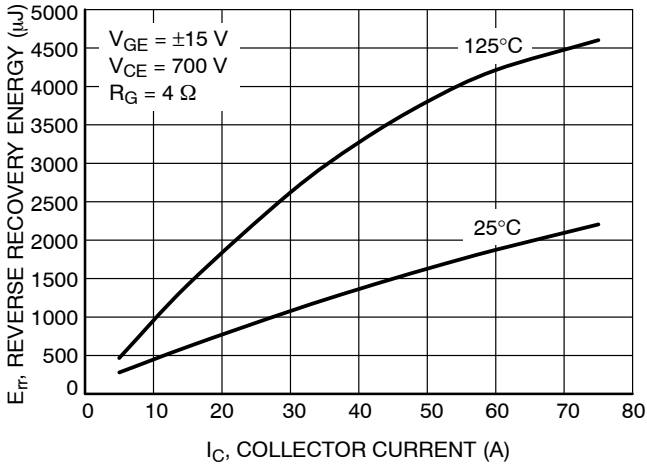

Figure 13. Typical Reverse Recovery Energy vs.  $I_C$

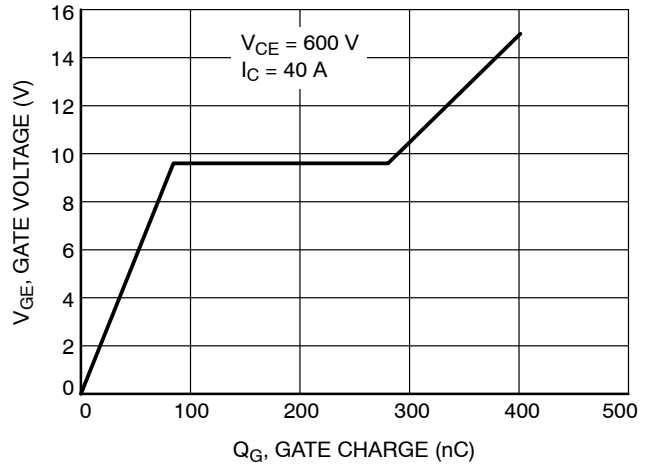

Figure 14. Gate Voltage vs. Gate Charge

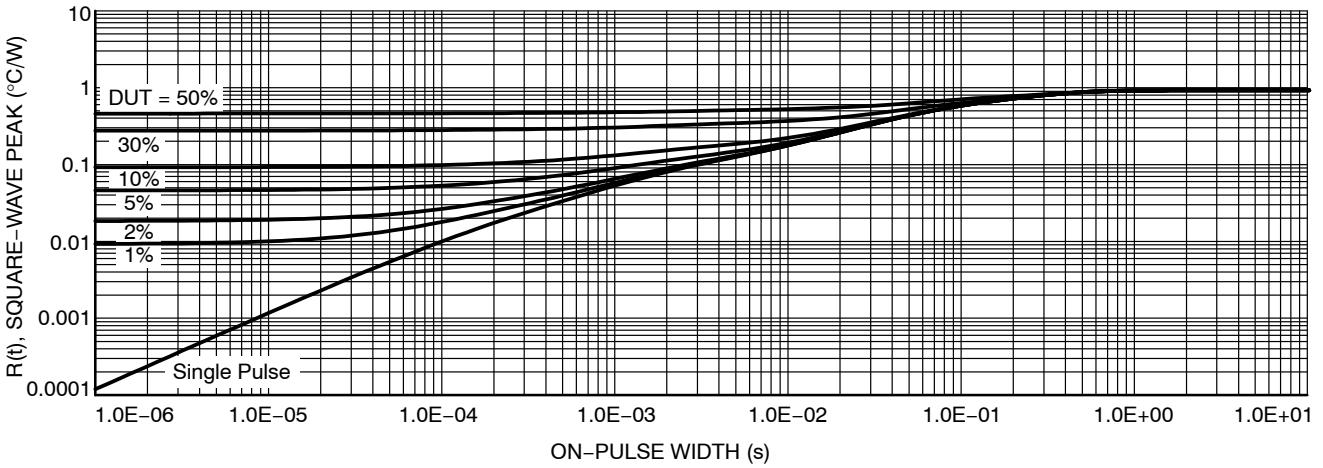

Figure 15. IGBT Transient Thermal Impedance

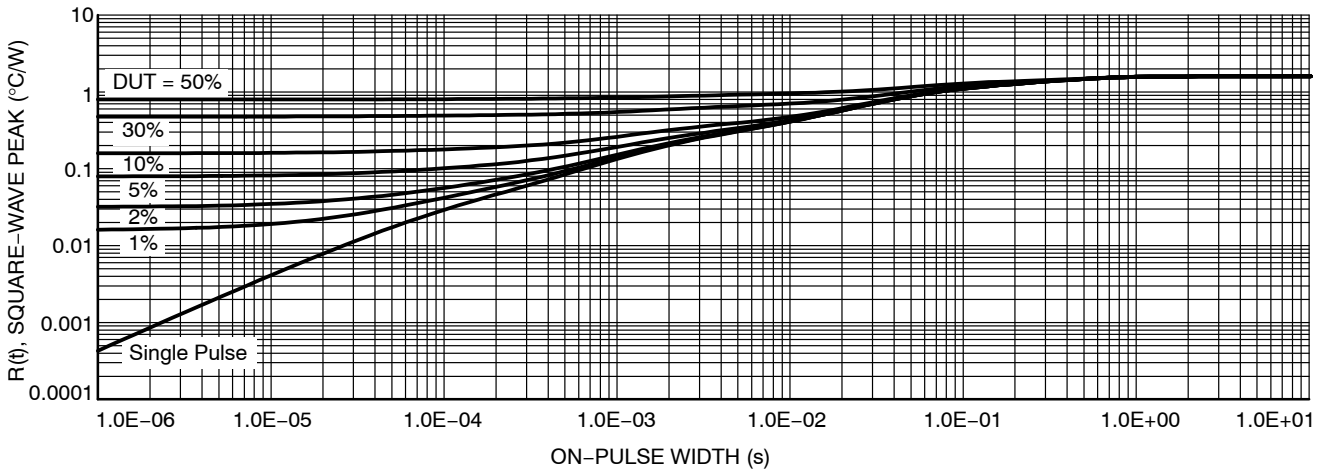

Figure 16. Diode Transient Thermal Impedance

# NXH80B120L2Q0

## TYPICAL CHARACTERISTICS – IGBT Protection Diode and Bypass Diode

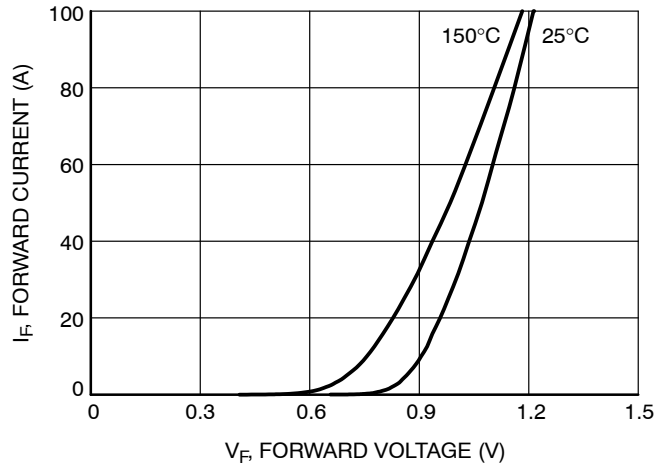

Figure 17. Diode Forward Characteristic

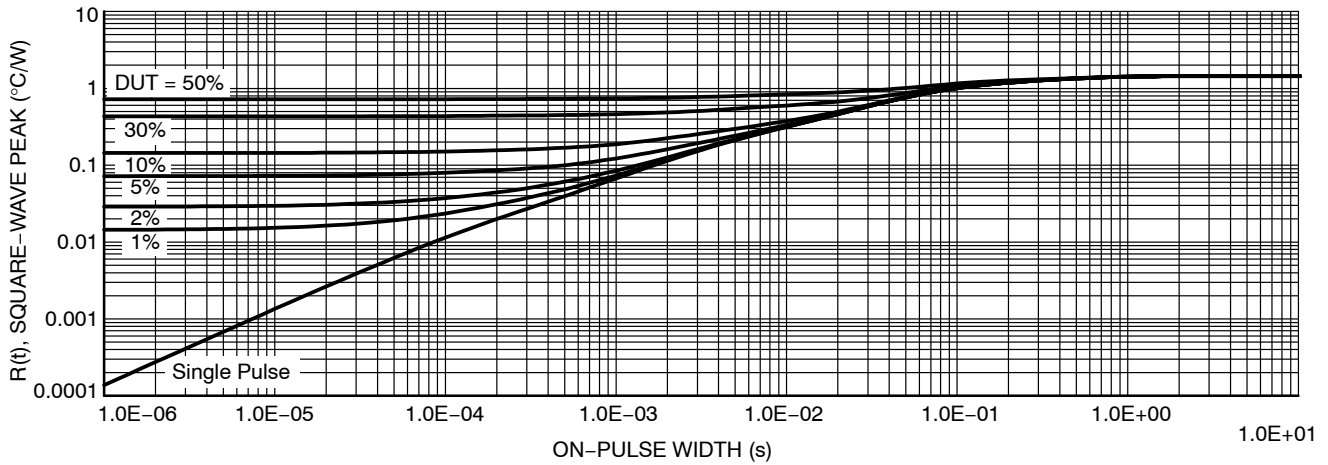

Figure 18. Diode Transient Thermal Impedance

## TYPICAL CHARACTERISTICS – Thermistor

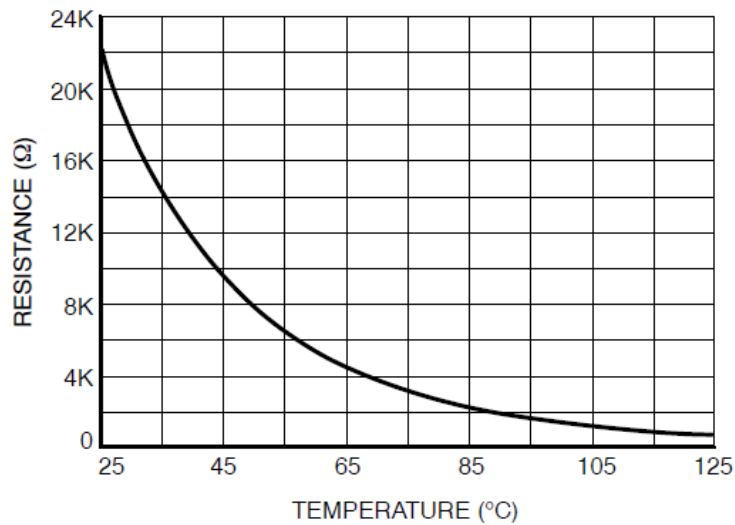

Figure 19. Thermistor Characteristic



# NXH80B120L2Q0

## PACKAGE DIMENSIONS

PIM22, 55x32.5 / Q0BOOST  
CASE 180AJ  
ISSUE A

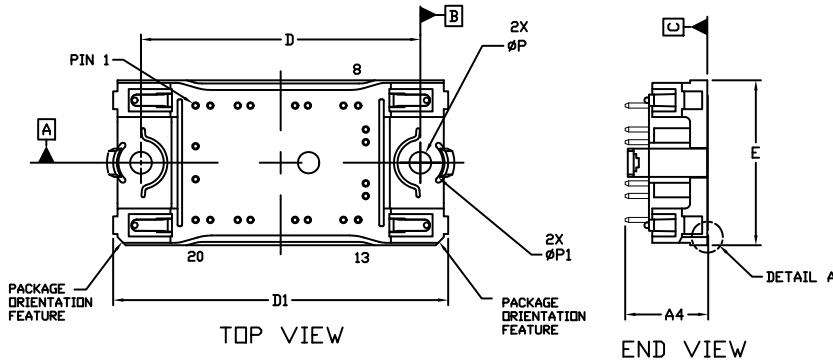

### NOTES:

1. DIMENSIONING AND TOLERANCING PER ASME Y14.5M, 2009.
2. CONTROLLING DIMENSION: MILLIMETERS
3. DIMENSION *b* APPLIES TO THE PLATED TERMINALS AND IS MEASURED BETWEEN 1.00 AND 3.00 FROM THE TERMINAL TIP.
4. POSITION OF THE CENTER OF THE TERMINALS IS DETERMINED FROM DATUM B THE CENTER OF DIMENSION D, X DIRECTION, AND FROM DATUM A, Y DIRECTION. POSITIONAL TOLERANCE, AS NOTED IN DRAWING, APPLIES TO EACH TERMINAL IN BOTH DIRECTIONS.
5. PACKAGE MARKING IS LOCATED AS SHOWN ON THE SIDE OPPOSITE THE PACKAGE ORIENTATION FEATURES.

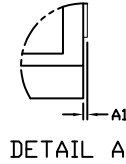
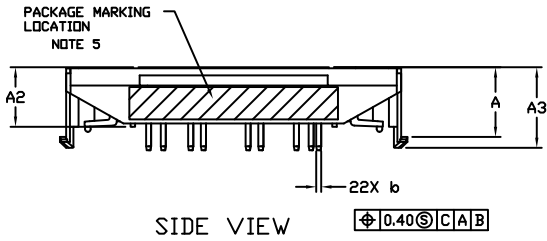

DIM	MILLIMETERS	
	MIN.	NOM.
A	13.50	13.90
A1	0.10	0.30
A2	11.50	11.90
A3	15.65	16.05
A4	16.35	REF
<i>b</i>	0.95	1.05
D	54.80	55.20
D1	65.60	66.20
E	32.20	32.80
P	4.20	4.40
P1	8.90	9.10

### NOTE 4

PIN	PIN POSITION		PIN	PIN POSITION	
	X	Y		X	Y
1	-16.75	11.25	12	16.75	-6.55
2	-13.85	11.25	13	15.25	-11.25
3	-8.45	11.25	14	12.35	-11.25
4	-5.95	11.25	15	5.35	-11.25
5	2.85	11.25	16	2.85	-11.25
6	5.35	11.25	17	-5.95	-11.25
7	12.35	11.25	18	-8.45	-11.25
8	15.25	11.25	19	-13.85	-11.25
9	16.75	6.55	20	-16.75	-11.25
10	16.75	4.05	21	-16.75	-3.25
11	16.75	-4.05	22	-16.75	3.25

# NXH80B120L2Q0

## PACKAGE DIMENSIONS

PIM22, 55x32.5 / Q0BOOST  
CASE 180AJ  
ISSUE A

### MOUNTING HOLE POSITION

PIN	HOLE POSITION		PIN	PIN POSITION	
	X	Y		X	Y
1	-16.75	-11.25	12	16.75	6.55
2	-13.85	-11.25	13	15.25	11.25
3	-8.45	-11.25	14	12.35	11.25
4	-5.95	-11.25	15	5.35	11.25
5	2.85	-11.25	16	2.85	11.25
6	5.35	-11.25	17	-5.95	11.25
7	12.35	-11.25	18	-8.45	11.25
8	15.25	-11.25	19	-13.85	11.25
9	16.75	-6.55	20	-16.75	11.25
10	16.75	-4.05	21	-16.75	3.25
11	16.75	4.05	22	-16.75	-3.25

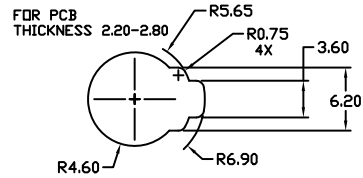
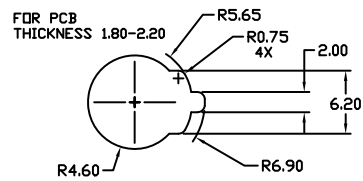
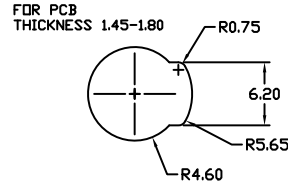
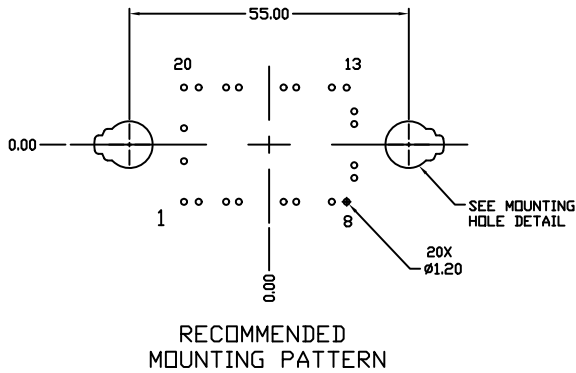

MOUNTING HOLE DETAIL

ON Semiconductor and are trademarks of Semiconductor Components Industries, LLC dba ON Semiconductor or its subsidiaries in the United States and/or other countries. ON Semiconductor owns the rights to a number of patents, trademarks, copyrights, trade secrets, and other intellectual property. A listing of ON Semiconductor's product/patent coverage may be accessed at [www.onsemi.com/site/pdf/Patent-Marking.pdf](http://www.onsemi.com/site/pdf/Patent-Marking.pdf). ON Semiconductor reserves the right to make changes without further notice to any products herein. ON Semiconductor makes no warranty, representation or guarantee regarding the suitability of its products for any particular purpose, nor does ON Semiconductor assume any liability arising out of the application or use of any product or circuit, and specifically disclaims any and all liability, including without limitation special, consequential or incidental damages. Buyer is responsible for its products and applications using ON Semiconductor products, including compliance with all laws, regulations and safety requirements or standards, regardless of any support or applications information provided by ON Semiconductor. "Typical" parameters which may be provided in ON Semiconductor data sheets and/or specifications can and do vary in different applications and actual performance may vary over time. All operating parameters, including "Typicals" must be validated for each customer application by customer's technical experts. ON Semiconductor does not convey any license under its patent rights nor the rights of others. ON Semiconductor products are not designed, intended, or authorized for use as a critical component in life support systems or any FDA Class 3 medical devices or medical devices with a same or similar classification in a foreign jurisdiction or any devices intended for implantation in the human body. Should Buyer purchase or use ON Semiconductor products for any such unintended or unauthorized application, Buyer shall indemnify and hold ON Semiconductor and its officers, employees, subsidiaries, affiliates, and distributors harmless against all claims, costs, damages, and expenses, and reasonable attorney fees arising out of, directly or indirectly, any claim of personal injury or death associated with such unintended or unauthorized use, even if such claim alleges that ON Semiconductor was negligent regarding the design or manufacture of the part. ON Semiconductor is an Equal Opportunity/Affirmative Action Employer. This literature is subject to all applicable copyright laws and is not for resale in any manner.

### PUBLICATION ORDERING INFORMATION

**LITERATURE FULFILLMENT:**  
Literature Distribution Center for ON Semiconductor  
19521 E. 32nd Pkwy, Aurora, Colorado 80011 USA  
**Phone:** 303-675-2175 or 800-344-3860 Toll Free USA/Canada  
**Fax:** 303-675-2176 or 800-344-3867 Toll Free USA/Canada  
**Email:** [orderlit@onsemi.com](mailto:orderlit@onsemi.com)

**N. American Technical Support:** 800-282-9855 Toll Free  
USA/Canada  
**Europe, Middle East and Africa Technical Support:**  
Phone: 421 33 790 2910

**ON Semiconductor Website:** [www.onsemi.com](http://www.onsemi.com)  
**Order Literature:** <http://www.onsemi.com/orderlit>

For additional information, please contact your local Sales Representative