



Is Now Part of



**ON Semiconductor®**

To learn more about ON Semiconductor, please visit our website at  
[www.onsemi.com](http://www.onsemi.com)

Please note: As part of the Fairchild Semiconductor integration, some of the Fairchild orderable part numbers will need to change in order to meet ON Semiconductor's system requirements. Since the ON Semiconductor product management systems do not have the ability to manage part nomenclature that utilizes an underscore (\_), the underscore (\_) in the Fairchild part numbers will be changed to a dash (-). This document may contain device numbers with an underscore (\_). Please check the ON Semiconductor website to verify the updated device numbers. The most current and up-to-date ordering information can be found at [www.onsemi.com](http://www.onsemi.com). Please email any questions regarding the system integration to [Fairchild\\_questions@onsemi.com](mailto:Fairchild_questions@onsemi.com).

ON Semiconductor and the ON Semiconductor logo are trademarks of Semiconductor Components Industries, LLC dba ON Semiconductor or its subsidiaries in the United States and/or other countries. ON Semiconductor owns the rights to a number of patents, trademarks, copyrights, trade secrets, and other intellectual property. A listing of ON Semiconductor's product/patent coverage may be accessed at [www.onsemi.com/site/pdf/Patent-Marking.pdf](http://www.onsemi.com/site/pdf/Patent-Marking.pdf). ON Semiconductor reserves the right to make changes without further notice to any products herein. ON Semiconductor makes no warranty, representation or guarantee regarding the suitability of its products for any particular purpose, nor does ON Semiconductor assume any liability arising out of the application or use of any product or circuit, and specifically disclaims any and all liability, including without limitation special, consequential or incidental damages. Buyer is responsible for its products and applications using ON Semiconductor products, including compliance with all laws, regulations and safety requirements or standards, regardless of any support or applications information provided by ON Semiconductor. "Typical" parameters which may be provided in ON Semiconductor data sheets and/or specifications can and do vary in different applications and actual performance may vary over time. All operating parameters, including "Typicals" must be validated for each customer application by customer's technical experts. ON Semiconductor does not convey any license under its patent rights nor the rights of others. ON Semiconductor products are not designed, intended, or authorized for use as a critical component in life support systems or any FDA Class 3 medical devices or medical devices with a same or similar classification in a foreign jurisdiction or any devices intended for implantation in the human body. Should Buyer purchase or use ON Semiconductor products for any such unintended or unauthorized application, Buyer shall indemnify and hold ON Semiconductor and its officers, employees, subsidiaries, affiliates, and distributors harmless against all claims, costs, damages, and expenses, and reasonable attorney fees arising out of, directly or indirectly, any claim of personal injury or death associated with such unintended or unauthorized use, even if such claim alleges that ON Semiconductor was negligent regarding the design or manufacture of the part. ON Semiconductor is an Equal Opportunity/Affirmative Action Employer. This literature is subject to all applicable copyright laws and is not for resale in any manner.



# SG6742ML/MR

## Highly Integrated Green-Mode PWM Controller

### Features

- High-Voltage Startup
- Low Operating Current: 2.7mA
- Linearly Decreasing PWM Frequency to 22KHz
- Frequency Hopping to Reduce EMI Emission
- Fixed PWM Frequency: 65KHz
- Peak-Current-Mode Control
- Cycle-by-Cycle Current Limiting
- Leading-Edge Blanking
- Synchronized Slope Compensation
- Internal Open-Loop Protection
- GATE Output Maximum Voltage Clamp: 18V
- V<sub>DD</sub> Under-Voltage Lockout (UVLO)
- V<sub>DD</sub> Over-Voltage Protection (OVP)
- Programmable Over-Temperature Protection (OTP)
- Internal Latch Circuit (OVP, OTP)
- Internal Sense Short-Circuit Protection
- Build-in 5ms Soft-Start Function
- Constant Power Limit (Full AC Input Range)
- Internal OTP Sensor with Hysteresis

### Applications

General-purpose switch-mode power supplies and flyback power converters, including:

- Power Adapters
- Open-Frame SMPS

### Description

The highly integrated SG6742ML/MR PWM controller provides several features to enhance the performance of flyback converters.

To minimize standby power consumption, a proprietary green-mode function provides off-time modulation to linearly decrease the switching frequency at light-load conditions. To avoid acoustic-noise problems, the minimum PWM frequency is set above 22KHz. The green-mode function enables the power supply to meet international power conservation requirements. With the internal high-voltage startup circuitry, the power loss due to bleeding resistors is also eliminated. To further reduce power consumption, SG6742ML/MR is manufactured using the BiCMOS process, which allows an operating current of only 2.7mA.

SG6742ML/MR integrates a frequency-hopping function that helps reduce EMI emission of a power supply with minimum line filters. Its built-in synchronized slope compensation achieves stable peak-current-mode control. The proprietary, internal line compensation ensures constant output power limit over a wide AC input voltage range, from 90V<sub>AC</sub> to 264V<sub>AC</sub>.

SG6742ML/MR provides many protection functions. In addition to cycle-by-cycle current limiting, the internal open-loop protection circuit ensures safety should an open-loop or output short-circuit failure occur. PWM output is disabled until V<sub>DD</sub> drops below the UVLO lower limit, when the controller starts up again. As long as V<sub>DD</sub> exceeds ~26V, the internal OVP circuit is triggered.

SG6742ML/MR is available in an 8-pin SOP package.

### Ordering Information

Part Number	Operating Temperature Range	OLP Function	Package	Eco Status	Packing Method
SG6742MLSY	-40 to +105°C	Latch	8-Lead Small Outline Package (SOP)	Green	Tape & Reel
SG6742MRSY	-40 to +105°C	Restart	8-Lead Small Outline Package (SOP)	Green	Tape & Reel

For Fairchild's definition of Eco Status, please visit: [http://www.fairchildsemi.com/company/green/rohs\\_green.html](http://www.fairchildsemi.com/company/green/rohs_green.html).

### Application Diagram

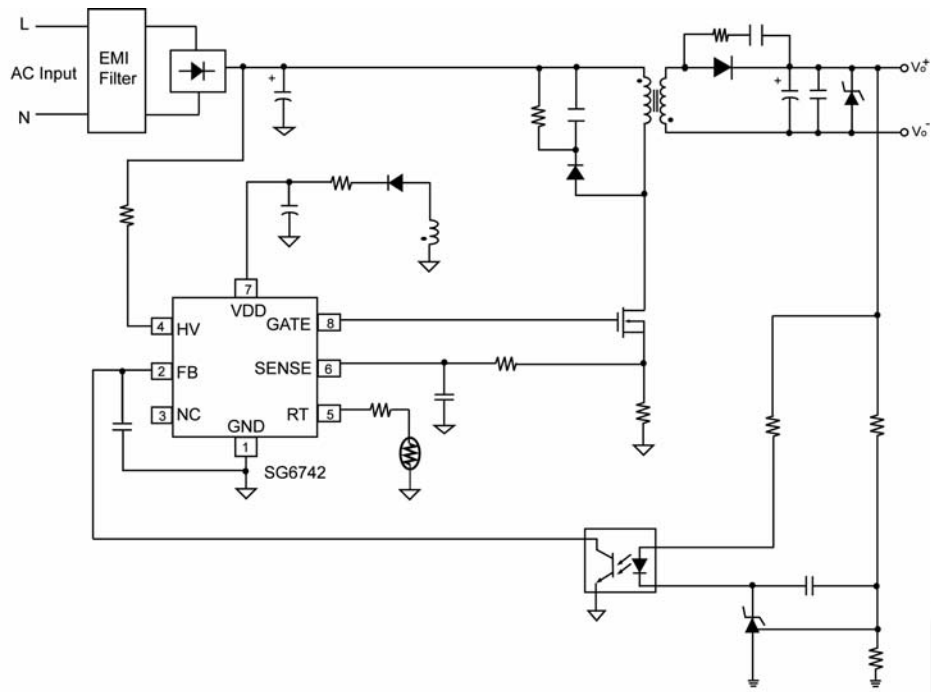

Figure 1. Typical Application

### Internal Block Diagram

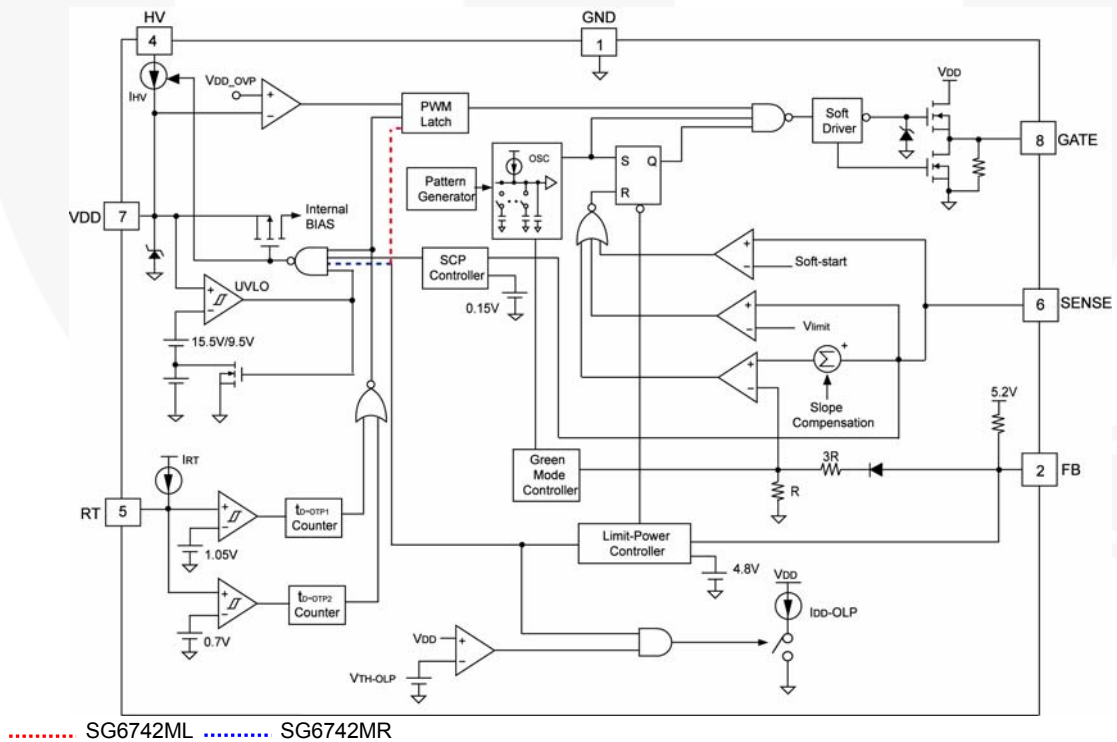
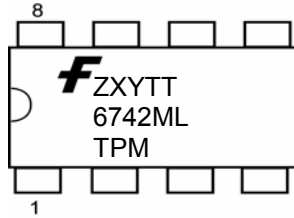
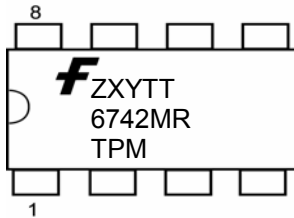

Figure 2. Functional Block Diagram

## Marking Information



F- Fairchild Logo  
 Z- Plant Code  
 X- 1 Digit Year Code  
 Y- 1 Digit week Code  
 TT: 2 Digits Die Run Code  
 T: Package Type (D=DIP, S=SOP)  
 P: Y: Green Package  
 M: Manufacture Flow Code

Figure 3. Top Mark

## Pin Configuration

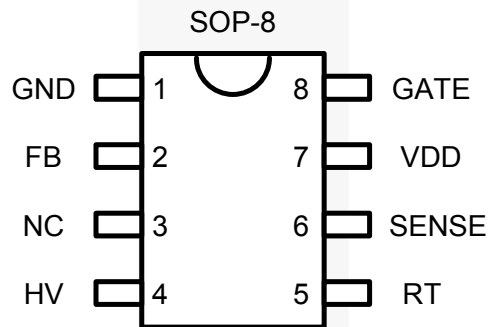

Figure 4. Pin Configuration (Top View)

## Pin Definitions

Pin #	Name	Description
1	GND	Ground.
2	FB	The signal from the external compensation circuit is fed into this pin. The PWM duty cycle is determined in response to the signal on this pin and the current-sense signal on the SENSE pin.
3	NC	No connection.
4	HV	For startup, this pin is pulled high to the line input or bulk capacitor via resistors.
5	RT	For over-temperature protection, an external NTC thermistor is connected from this pin to the GND pin. The impedance of the NTC decreases at high temperatures. Once the voltage of the RT pin drops below a fixed limit, PWM output is latched.
6	SENSE	Current sense. The sensed voltage is used for peak-current-mode control and cycle-by-cycle current limiting.
7	VDD	Power supply. The internal protection circuit disables PWM output as long as V <sub>DD</sub> exceeds the OVP trigger point.
8	GATE	The totem-pole output driver. Soft driving waveform is implemented for improved EMI.

## Absolute Maximum Ratings

Stresses exceeding the absolute maximum ratings may damage the device. The device may not function or be operable above the recommended operating conditions and stressing the parts to these levels is not recommended. In addition, extended exposure to stresses above the recommended operating conditions may affect device reliability. The absolute maximum ratings are stress ratings only.

Symbol	Parameter		Min.	Max.	Unit
V <sub>VDD</sub>	DC Supply Voltage <sup>(1, 2)</sup>			30	V
V <sub>FB</sub>	FB Pin Input Voltage		-0.3	7.0	V
V <sub>SENSE</sub>	SENSE Pin Input Voltage		-0.3	7.0	V
V <sub>RT</sub>	RT Pin Input Voltage		-0.3	7.0	V
V <sub>HV</sub>	HV Pin Input Voltage			500	V
P <sub>D</sub>	Power Dissipation (T <sub>A</sub> < 50°C)			400	mW
θ <sub>JA</sub>	Thermal Resistance (Junction-to-Air)			141	°C/W
T <sub>J</sub>	Operating Junction Temperature		-40	+125	°C
T <sub>STG</sub>	Storage Temperature Range		-55	+150	°C
T <sub>L</sub>	Lead Temperature (Wave Soldering or IR, 10 Seconds)			+260	°C
ESD	Electrostatic Discharge Capability, Human Body Model, JESD22-A114	All Pins Except HV Pin		4	kV
	Electrostatic Discharge Capability, Machine Model, JESD22-A115	All Pins Except HV Pin		200	V

### Notes:

- All voltage values, except differential voltages, are given with respect to the network ground terminal.
- Stresses beyond those listed under “absolute maximum ratings” may cause permanent damage to the device.

## Electrical Characteristics

$V_{DD}=15V$  and  $T_A=25^{\circ}C$  unless otherwise noted.

Symbol	Parameter	Conditions	Min.	Typ.	Max.	Units
<b>V<sub>DD</sub> Section</b>						
V <sub>OP</sub>	Continuously Operating Voltage				22	V
V <sub>DD-ON</sub>	Start Threshold Voltage		14.5	15.5	16.5	V
V <sub>DD-OFF</sub>	Minimum Operating Voltage		8.5	9.5	10.5	V
I <sub>DD-ST</sub>	Startup Current	V <sub>DD-ON</sub> – 0.16V			30	μA
I <sub>DD-OP</sub>	Operating Supply Current	V <sub>DD</sub> =15V, GATE Open		2.7	3.7	mA
I <sub>DD-OLP</sub>	Internal Sink Current	V <sub>TH-OLP</sub> +0.1V	30	60	90	μA
V <sub>TH-OLP</sub>	I <sub>DD-OLP</sub> Off Voltage		6.5	7.5	8.0	V
V <sub>DD-OVP</sub>	V <sub>DD</sub> Over-Voltage Protection		25	26	27	V
t <sub>D-VDDOVP</sub>	V <sub>DD</sub> Over-Voltage Protection Debounce Time		75	125	200	μs
<b>HV Section</b>						
I <sub>HV</sub>	Supply Current from HV Pin	V <sub>AC</sub> =90V (V <sub>DC</sub> =120V), V <sub>DD</sub> =10μF	1.5	2.3	3.1	mA
I <sub>HV-LC</sub>	Leakage Current After Startup	HV=500V, V <sub>DD</sub> =V <sub>DD-OFF</sub> +1V		1	20	μA
<b>Oscillator Section</b>						
f <sub>OSC</sub>	Frequency in Normal Mode	Center Frequency	62	65	68	KHz
		Hopping Range	±3.7	±4.2	±4.7	
t <sub>HOP</sub>	Hopping Period		3.9	4.4	4.9	ms
f <sub>OSC-G</sub>	Green-Mode Frequency		18	22	25	KHz
f <sub>DV</sub>	Frequency Variation vs. V <sub>DD</sub> Deviation	V <sub>DD</sub> =11V to 22V			5	%
f <sub>DT</sub>	Frequency Variation vs. Temperature Deviation	T <sub>A</sub> =-40 to 105°C			5	%

Continued on the following page...

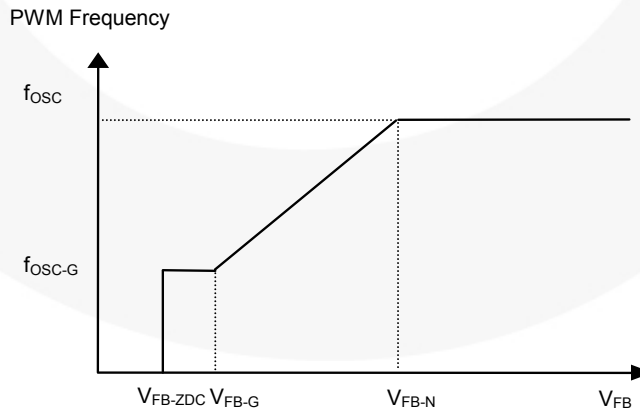

Figure 5.  $V_{FB}$  vs. PWM Frequency

**Electrical Characteristics** (Continued)

 $V_{DD}=15V$  and  $T_A=25^{\circ}C$  unless otherwise noted.

Symbol	Parameter	Conditions	Min.	Typ.	Max.	Units
<b>Feedback Input Section</b>						
$A_V$	Input Voltage to Current-Sense Attenuation		1/4.5	1/4.0	1/3.5	V/V
$Z_{FB}$	Input Impedance		4		7	k $\Omega$
$V_{FB-OPEN}$	Output High Voltage	FB Pin Open		5.2		V
$V_{FB-OLP}$	FB Open-Loop Trigger Level		4.6	4.8	5.0	V
$t_{D-OLP}$	Delay Time of FB Pin Open-Loop Protection		50	56	62	ms
$V_{FB-N}$	Green-Mode Entry FB Voltage		2.8	3.0	3.2	V
$V_{FB-G}$	Green-Mode Ending FB Voltage			$V_{FB-N}-0.6$		V
$V_{FB-ZDC}$	Zero Duty-Cycle Input Voltage			1.6		V
<b>Current-Sense Section</b>						
$Z_{SENSE}$	Input Impedance			12		K $\Omega$
$V_{STHFL}$	Current Limit Flatten Threshold Voltage		0.87	0.90	0.93	V
$V_{STHVA}$	Current Limit Valley Threshold Voltage	$V_{STHFL}-V_{STHVA}$	0.30	0.34	0.38	V
$t_{PD}$	Delay to Output			100	200	ns
$t_{LEB}$	Leading-Edge Blanking Time		100	150	200	ns
$V_{S-SCP}$	Threshold Voltage for SENSE Short-Circuit Protection		0.10	0.15	0.20	V
$t_{D-SSCP}$	Delay Time for SENSE Short-Circuit Protection	$V_{SENSE}<0.15V$	100	150	200	$\mu s$
$t_{SS}$	Period During Soft-Startup Time	Startup Time		5		ms
<b>GATE Section</b>						
$DCY_{MAX}$	Maximum Duty Cycle		60	65	70	%
$V_{GATE-L}$	Gate Low Voltage	$V_{DD}=15V, I_O=50mA$			1.5	V
$V_{GATE-H}$	Gate High Voltage	$V_{DD}=12V, I_O=50mA$	8			V
$t_r$	Gate Rising Time	$V_{DD}=15V, C_L=1nF$	150	250	350	ns
$t_f$	Gate Falling Time	$V_{DD}=15V, C_L=1nF$	30	50	90	ns
$I_{GATE-SOURCE}$	Gate Source Current	$V_{DD}=15V, GATE=6V$	250			mA
$V_{GATE-CLAMP}$	Gate Output Clamping Voltage	$V_{DD}=22V$			18	V
<b>RT Section</b>						
$I_{RT}$	Output Current from RT Pin		92	100	108	$\mu A$
$V_{RTTH1}$	Over-Temperature Protection Threshold Voltage	$0.7V < V_{RT} < 1.05V$ , After 12ms Latch Off	1.015	1.050	1.085	V
$V_{RTTH2}$		$V_{RT} < 0.7V$ , After 100 $\mu s$ Latch Off	0.65	0.70	0.75	V
$t_{D-OTP1}$	Over-Temperature Latch-off Debounce	$V_{RTTH2} < V_{RT} < V_{RTTH1}$	8	12	16	ms
$t_{D-OTP2}$		$V_{RT} < V_{RTTH2}$	40	100	160	$\mu s$
<b>Over-Temperature Protection Section (OTP)</b>						
$T_{OTP}$	Protection Junction Temperature <sup>(3)</sup>			+135		$^{\circ}C$
$T_{Restart}$	Restart Junction Temperature <sup>(4)</sup>			$T_{OTP}-25$		$^{\circ}C$

**Notes:**

- When activated, the output is disabled and the latch is turned off.
- The threshold temperature for enabling the output again and resetting the latch after OTP has been activated.

## Typical Performance Characteristics

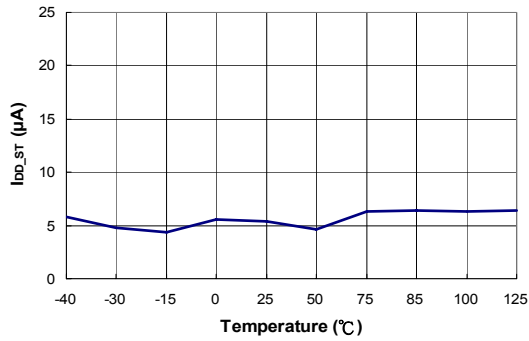

**Figure 6. Startup Current ( $I_{DD-ST}$ ) vs. Temperature**

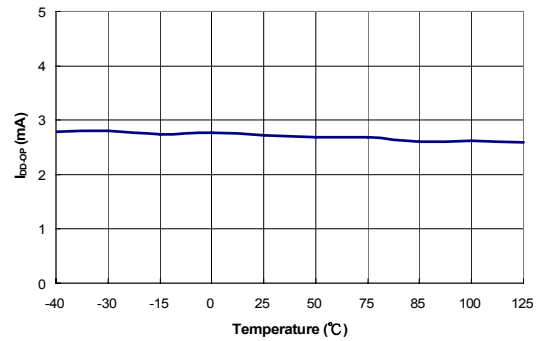

**Figure 7. Operation Supply Current ( $I_{DD-OP}$ ) vs. Temperature**

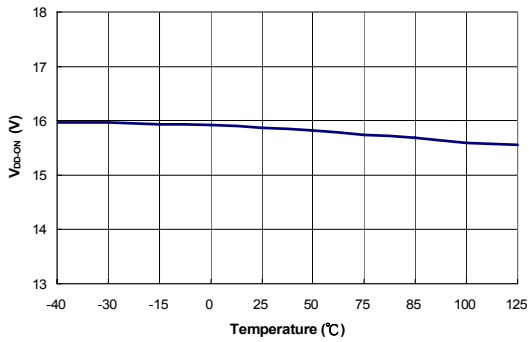

**Figure 8. Start Threshold Voltage ( $V_{DD-ON}$ ) vs. Temperature**

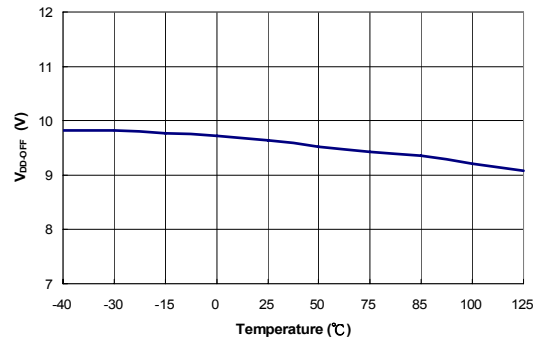

**Figure 9. Minimum Operating Voltage ( $V_{DD-OFF}$ ) vs. Temperature**

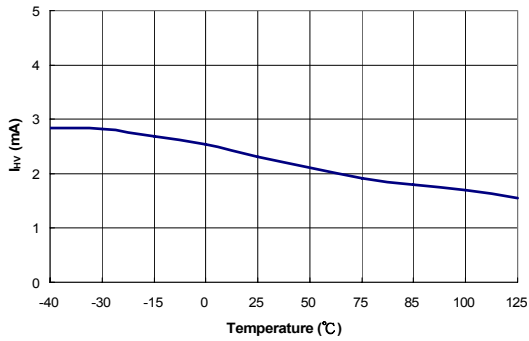

**Figure 10. Supply Current Drawn from HV Pin ( $I_{HV}$ ) vs. Temperature**

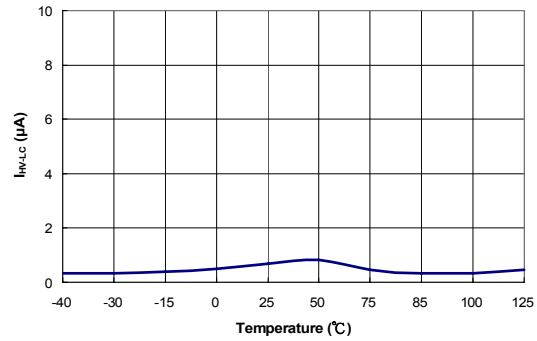

**Figure 11. HV Pin Leakage Current After Startup ( $I_{HV-LC}$ ) vs. Temperature**

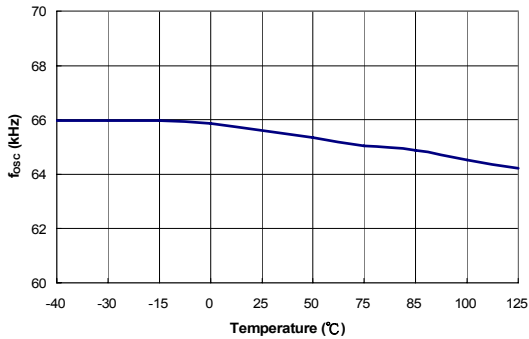

**Figure 12. Frequency in Normal Mode ( $f_{osc}$ ) vs. Temperature**

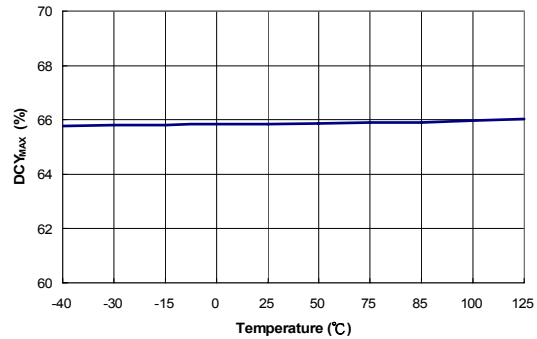

**Figure 13. Maximum Duty Cycle ( $DCY_{MAX}$ ) vs. Temperature**



### Typical Performance Characteristics

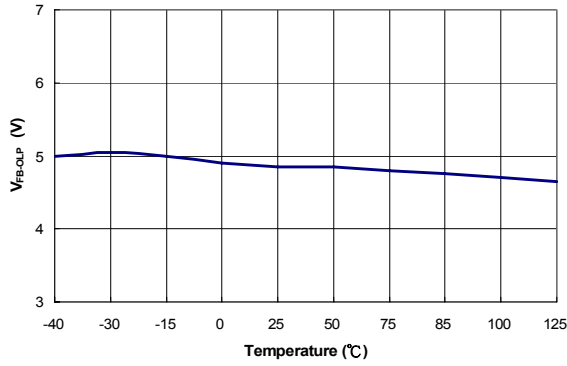

**Figure 14. FB Open-Loop Trigger Level (V<sub>FB-OLP</sub>) vs. Temperature**

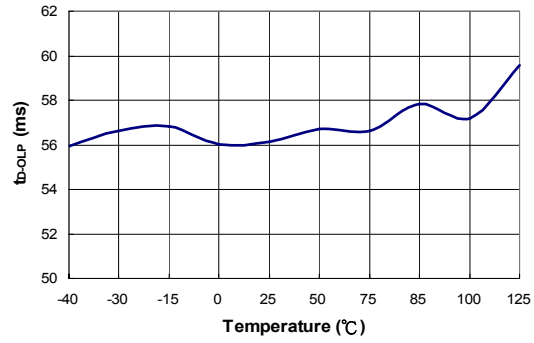

**Figure 15. Delay Time of FB Pin Open-Loop Protection (t<sub>D-OLP</sub>) vs. Temperature**

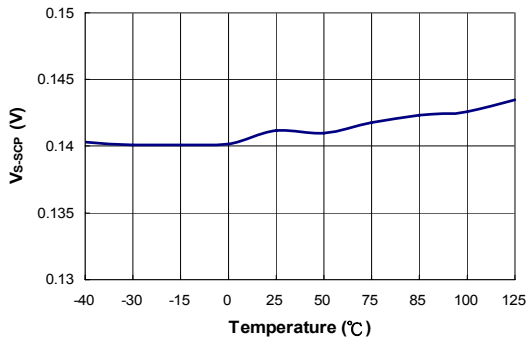

**Figure 16. Threshold Voltage for SENSE Short-Circuit Protection (V<sub>S-SCP</sub>) vs. Temperature**

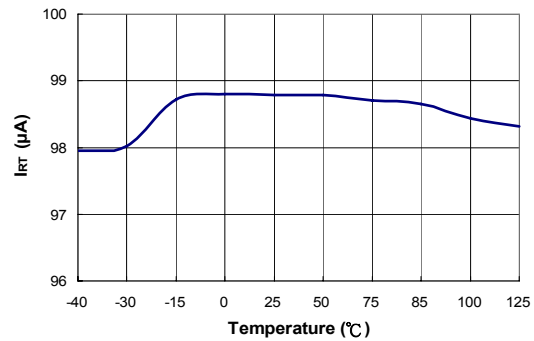

**Figure 17. Output Current from RT Pin (I<sub>RT</sub>) vs. Temperature**

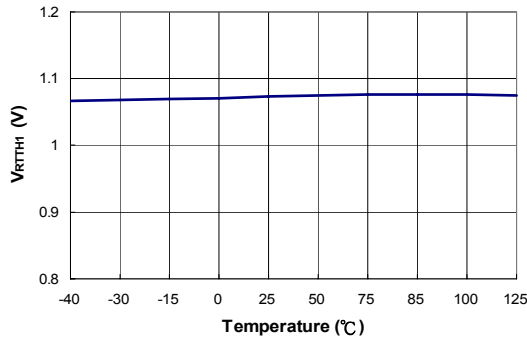

**Figure 18. Over-Temperature Protection Threshold Voltage (V<sub>RTTH1</sub>) vs. Temperature**

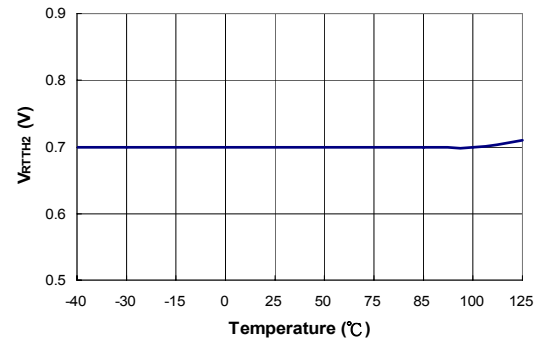

**Figure 19. Over-Temperature Protection Threshold Voltage (V<sub>RTTH2</sub>) vs. Temperature**

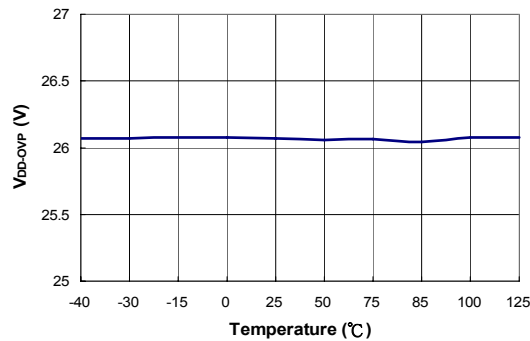

**Figure 20. V<sub>DD</sub> Over-Voltage Protection (V<sub>DD-OVP</sub>) vs. Temperature**

## Functional Description

### Startup Current

For startup, the HV pin is connected to the line input or bulk capacitor through an external diode and resistor,  $R_{HV}$ , (1N4007 / 100K $\Omega$  recommended). Typical startup current drawn from the HV pin is 2.3mA and charges the hold-up capacitor through the diode and resistor. When the  $V_{DD}$  capacitor level reaches  $V_{DD-ON}$ , the startup current switches off. At this moment, the  $V_{DD}$  capacitor only supplies the SG6742ML/MR to keep the  $V_{DD}$  before the auxiliary winding of the main transformer provides the operating current.

### Operating Current

Operating current is around 2.7mA. The low operating current enables better efficiency and reduces the requirement of  $V_{DD}$  hold-up capacitance.

### Green-Mode Operation

The proprietary green-mode function provides off-time modulation to reduce the switching frequency in light-load and no-load conditions. The on time is limited for better abnormal or brownout protection.  $V_{FB}$ , which is derived from the voltage feedback loop, is taken as the reference. Once  $V_{FB}$  is lower than the threshold voltage, switching frequency is continuously decreased to the minimum green-mode frequency of around 22KHz.

### Current Sensing / PWM Current Limiting

Peak-current-mode control is utilized to regulate output voltage and provide pulse-by-pulse current limiting. The switch current is detected by a sense resistor into the SENSE pin. The PWM duty cycle is determined by this current-sense signal and  $V_{FB}$ , the feedback voltage. When the voltage on SENSE pin reaches around  $V_{COMP}=(V_{FB}-0.6)/4$ , the switch cycle is terminated immediately.  $V_{COMP}$  is internally clamped to a variable voltage around 0.85V for output power limit.

### Leading-Edge Blanking (LEB)

Each time the power MOSFET is switched on, a turn-on spike occurs on the sense-resistor. To avoid premature termination of the switching pulse, a leading-edge blanking time is built in. During this blanking period, the current-limit comparator is disabled and cannot switch off the gate driver.

### Under-Voltage Lockout (UVLO)

The turn-on and turn-off thresholds are fixed internally at 15.5V and 9.5V. During startup, the hold-up capacitor must be charged to 15.5V through the startup resistor to enable the IC. The hold-up capacitor continues to supply  $V_{DD}$  before the energy can be delivered from auxiliary winding of the main transformer.  $V_{DD}$  must not drop below 9.5V during startup. This UVLO hysteresis window ensures that hold-up capacitor is adequate to supply  $V_{DD}$  during startup.

### Gate Output / Soft Driving

The BiCMOS output stage is a fast totem-pole gate driver. Cross conduction has been avoided to minimize heat dissipation, increase efficiency, and enhance reliability. The output driver is clamped by an internal 18V Zener diode to protect power MOSFET transistors against undesirable gate over voltage. A soft driving waveform is implemented to minimize EMI.

### Soft-Start

For many applications, it is necessary to minimize the inrush current at startup. The built-in 5ms soft-start circuit significantly reduces the startup current spike and output voltage overshoot.

### Built-in Slope Compensation

The sensed voltage across the current-sense resistor is used for peak-current-mode control and pulse-by-pulse current limiting. Built-in slope compensation improves stability and prevents sub-harmonic oscillation. SG6742ML/MR inserts a synchronized, positive-going, ramp at every switching cycle.

### Constant Output Power Limit

When the SENSE voltage across sense resistor  $R_S$  reaches the threshold voltage, around 0.9V, the output GATE drive is turned off after a small delay,  $t_{PD}$ . This delay introduces an additional current proportional to  $t_{PD} \cdot V_{IN} / L_P$ . Since the delay is nearly constant regardless of the input voltage  $V_{IN}$ , higher input voltage results in a larger additional current and the output power limit is higher than under low input line voltage. To compensate this variation for a wide AC input range, a sawtooth power-limiter is designed to solve the unequal power-limit problem. The power limiter is designed as a positive ramp signal fed to the inverting input of the OCP comparator. This results in a lower current limit at high-line inputs than at low-line inputs.

### $V_{DD}$ Over-Voltage Protection (OVP)

$V_{DD}$  over-voltage protection is built in to prevent damage due to abnormal conditions. If the  $V_{DD}$  voltage is over the over-voltage protection voltage ( $V_{DD-OVP}$ ) and lasts for  $t_{D-VDDOVP}$ , the PWM pulses are disabled until the  $V_{DD}$  voltage drops below the UVLO, then starts again. Over-voltage conditions are usually caused by open feedback loops.

### Thermal Protection

An NTC thermistor,  $R_{NTC}$ , in series with resistor  $R_A$ , can be connected from the RT pin to ground. A constant current  $I_{RT}$  is output from the RT pin. The voltage on the RT pin can be expressed as  $V_{RT}=I_{RT} \cdot (R_{NTC} + R_A)$ , where  $I_{RT}$  is 100 $\mu$ A. At high ambient temperatures,  $R_{NTC}$  is smaller, such that  $V_{RT}$  decreases. When  $V_{RT}$  is less than 1.05V ( $V_{RTTH1}$ ), the PWM turns off after 12ms ( $t_{D-OTP1}$ ). If  $V_{RT}$  is less than 0.7V ( $V_{RTTH2}$ ), PWM turns off after 100 $\mu$ s ( $t_{D-OTP2}$ ).

## Functional Description (Continued)

### Limited Power Control

The FB voltage increases every time the output of the power supply is shorted or overloaded. If the FB voltage remains higher than a built-in threshold for longer than  $t_{D-OLP}$ , PWM output is turned off. As PWM output is turned off,  $V_{DD}$  begins decreasing.

When  $V_{DD}$  goes below the turn-off threshold ( $\sim 9.5V$ ) the controller is totally shut down.  $V_{DD}$  is charged up to the turn-on threshold voltage of 15.5V through the startup resistor until PWM output is restarted. This protection feature continues as long as the overloading condition persists. This prevents the power supply from overheating due to overloading conditions. When  $V_{RT}$  is less than 1.05V ( $V_{RTTH1}$ ), the PWM is turned off after 12ms ( $t_{D-OTP1}$ ). If  $V_{RT}$  is less than 0.7V ( $V_{RTTH2}$ ), PWM is turned off after 100 $\mu$ s ( $t_{D-OTP2}$ ).

### Noise Immunity

Noise on the current sense or control signal may cause significant pulse-width jitter, particularly in continuous-conduction mode. Slope compensation helps alleviate this problem. Good placement and layout practices should be followed. Avoiding long PCB traces and component leads, locating compensation and filter components near the SG6742ML/MR, and increasing the power MOS gate resistance improve performance.

## Applications Information

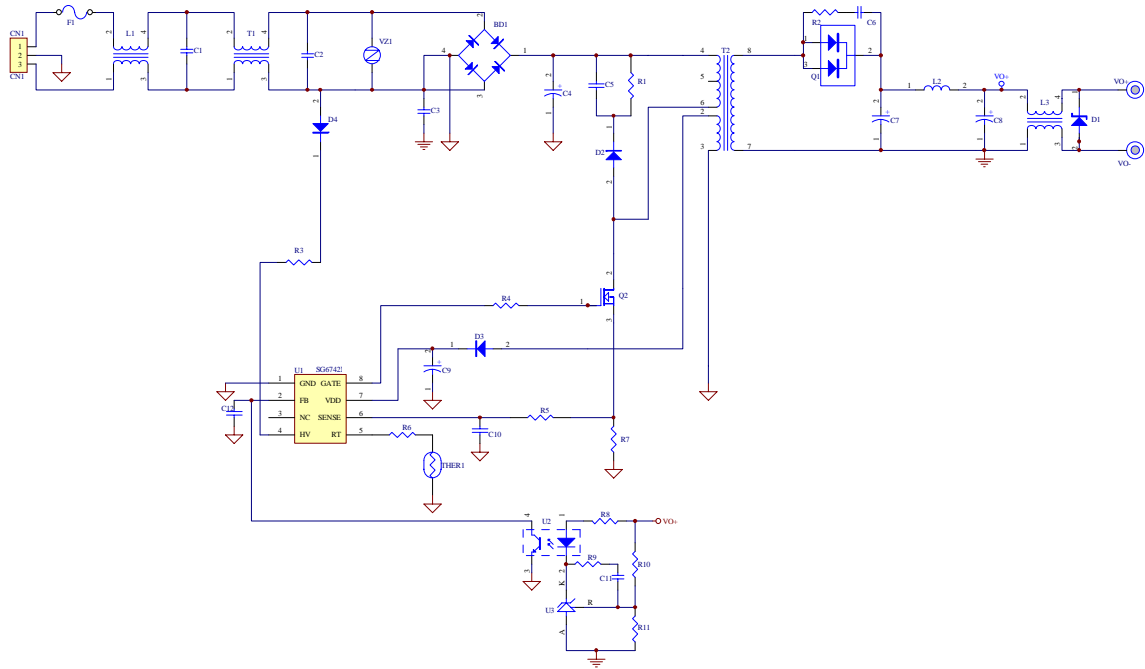

Figure 21. 60W Flyback 12V/5A Application Circuit

## BOM

Designator	Part Type	Designator	Part Type
BD1	BD 4A/600V	L3	Inductor (900μH)
C1	XC 0.68μF/300V	Q1	STP20-100CT
C2	XC 0.1μF/300V	Q2	MOS 7A/600V
C3	YC 2200pF/Y1	R1	R 100KΩ 1/2W
C4	EC 120μF/400V	R2	R 47Ω 1/4W
C5	CC 0.01μF/500V	R3	R 100KΩ 1/2W
C6	CC 1000pF/100V	R4	R 4.7Ω 1/8W
C7	EC 1000μF/25V	R5	R 100Ω 1/8W
C8	EC 470μF/25V	R6, R9	R 4.7KΩ 1/8W
C9	EC 22μF/50V	R7	R 0.3Ω 2W
C10	CC 47pF/50V	R8	R 680Ω 1/8W
C11	CC 2200pF/50V	R10	R 150KΩ 1/8W
C12	CC 0.01μF/50V	R11	R 39KΩ 1/8W
D1	Zener Diode 15V 1/2W (option)	THER1	Thermistor TTC104
D2	BYV95C	T1	10mH
D3	FR103	T2	600μH(PQ2620)
D4	1N4007	U1	IC SG6742
F1	FUSE 4A/250V	U2	IC PC817
L1	Inductor (900μH)	U3	IC TL431
L2	Inductor (2μH)	VZ1	VZ 9G





**TRADEMARKS**

The following includes registered and unregistered trademarks and service marks, owned by Fairchild Semiconductor and/or its global subsidiaries, and is not intended to be an exhaustive list of all such trademarks.

- |                          |                        |                                       |                      |
|--------------------------|------------------------|---------------------------------------|----------------------|
| Auto-SPM™                | F-PFST™                | PowerTrench®                          | The Power Franchise® |
| Build it Now!™           | FRFET®                 | PowerXS™                              |                      |
| CorePLUSTM               | Global Power Resource™ | Programmable Active Droop™            | TinyBoost™           |
| CorePOWER™               | Green FPS™             | QFET®                                 | TinyBuck™            |
| CROSSVOLT™               | Green FPS™ e-Series™   | QS™                                   | TinyLogic®           |
| CTL™                     | Gmax™                  | Quiet Series™                         | TINYOPTO™            |
| Current Transfer Logic™  | GTO™                   | RapidConfigure™                       | TinyPower™           |
| EcoSPARK®                | IntelliMAX™            |                                       | TinyPWM™             |
| EfficientMax™            | ISOPLANAR™             | Saving our world, 1mW/W/kW at a time™ | TinyWire™            |
| EZSWITCH™                | MegaBuck™              | SmartMax™                             | TriFault Detect™     |
|                          | MICROCOUPLER™          | SMART START™                          | TRUECURRENT™         |
|                          | MicroFET™              | SPM®                                  | µSerDes™             |
| Fairchild®               | MillerDrive™           | STEALTH™                              |                      |
| Fairchild Semiconductor® | MotionMax™             | SuperFET™                             | UHC®                 |
| FACT Quiet Series™       | Motion-SPM™            | SuperSOT™.3                           | Ultra FRFET™         |
| FACT®                    | OPTOLOGIC®             | SuperSOT™.6                           | UniFET™              |
| FAST®                    | OPTOPLANAR®            | SuperSOT™.8                           | Vcx™                 |
| FastvCore™               |                        | SupreMOS™                             | VisualMax™           |
| FETBench™                | PDP SPM™               | SyncFET™                              | XST™                 |
| FlashWriter®             | Power-SPM™             | Sync-Lock™                            |                      |
| FPST™                    |                        |                                       |                      |

\* Trademarks of System General Corporation, used under license by Fairchild Semiconductor.

**DISCLAIMER**

FAIRCHILD SEMICONDUCTOR RESERVES THE RIGHT TO MAKE CHANGES WITHOUT FURTHER NOTICE TO ANY PRODUCTS HEREIN TO IMPROVE RELIABILITY, FUNCTION, OR DESIGN. FAIRCHILD DOES NOT ASSUME ANY LIABILITY ARISING OUT OF THE APPLICATION OR USE OF ANY PRODUCT OR CIRCUIT DESCRIBED HEREIN; NEITHER DOES IT CONVEY ANY LICENSE UNDER ITS PATENT RIGHTS, NOR THE RIGHTS OF OTHERS. THESE SPECIFICATIONS DO NOT EXPAND THE TERMS OF FAIRCHILD'S WORLDWIDE TERMS AND CONDITIONS, SPECIFICALLY THE WARRANTY THEREIN, WHICH COVERS THESE PRODUCTS.

**LIFE SUPPORT POLICY**

FAIRCHILD'S PRODUCTS ARE NOT AUTHORIZED FOR USE AS CRITICAL COMPONENTS IN LIFE SUPPORT DEVICES OR SYSTEMS WITHOUT THE EXPRESS WRITTEN APPROVAL OF FAIRCHILD SEMICONDUCTOR CORPORATION.

As used herein:

1. Life support devices or systems are devices or systems which, (a) are intended for surgical implant into the body or (b) support or sustain life, and (c) whose failure to perform when properly used in accordance with instructions for use provided in the labeling, can be reasonably expected to result in a significant injury of the user.
2. A critical component in any component of a life support, device, or system whose failure to perform can be reasonably expected to cause the failure of the life support device or system, or to affect its safety or effectiveness.

**ANTI-COUNTERFEITING POLICY**

Fairchild Semiconductor Corporation's Anti-Counterfeiting Policy. Fairchild's Anti-Counterfeiting Policy is also stated on our external website, [www.fairchildsemi.com](http://www.fairchildsemi.com), under Sales Support.

Counterfeiting of semiconductor parts is a growing problem in the industry. All manufacturers of semiconductor products are experiencing counterfeiting of their parts. Customers who inadvertently purchase counterfeit parts experience many problems such as loss of brand reputation, substandard performance, failed applications, and increased cost of production and manufacturing delays. Fairchild is taking strong measures to protect ourselves and our customers from the proliferation of counterfeit parts. Fairchild strongly encourages customers to purchase Fairchild parts either directly from Fairchild or from Authorized Fairchild Distributors who are listed by country on our web page cited above. Products customers buy either from Fairchild directly or from Authorized Fairchild Distributors are genuine parts, have full traceability, meet Fairchild's quality standards for handling and storage and provide access to Fairchild's full range of up-to-date technical and product information. Fairchild and our Authorized Distributors will stand behind all warranties and will appropriately address any warranty issues that may arise. Fairchild will not provide any warranty coverage or other assistance for parts bought from Unauthorized Sources. Fairchild is committed to combat this global problem and encourage our customers to do their part in stopping this practice by buying direct or from authorized distributors.

**PRODUCT STATUS DEFINITIONS**

**Definition of Terms**

Datasheet Identification	Product Status	Definition
Advance Information	Formative / In Design	Datasheet contains the design specifications for product development. Specifications may change in any manner without notice.
Preliminary	First Production	Datasheet contains preliminary data; supplementary data will be published at a later date. Fairchild Semiconductor reserves the right to make changes at any time without notice to improve design.
No Identification Needed	Full Production	Datasheet contains final specifications. Fairchild Semiconductor reserves the right to make changes at any time without notice to improve the design.
Obsolete	Not In Production	Datasheet contains specifications on a product that is discontinued by Fairchild Semiconductor. The datasheet is for reference information only.

Rev. 140

ON Semiconductor and  are trademarks of Semiconductor Components Industries, LLC dba ON Semiconductor or its subsidiaries in the United States and/or other countries. ON Semiconductor owns the rights to a number of patents, trademarks, copyrights, trade secrets, and other intellectual property. A listing of ON Semiconductor's product/patent coverage may be accessed at [www.onsemi.com/site/pdf/Patent-Marking.pdf](http://www.onsemi.com/site/pdf/Patent-Marking.pdf). ON Semiconductor reserves the right to make changes without further notice to any products herein. ON Semiconductor makes no warranty, representation or guarantee regarding the suitability of its products for any particular purpose, nor does ON Semiconductor assume any liability arising out of the application or use of any product or circuit, and specifically disclaims any and all liability, including without limitation special, consequential or incidental damages. Buyer is responsible for its products and applications using ON Semiconductor products, including compliance with all laws, regulations and safety requirements or standards, regardless of any support or applications information provided by ON Semiconductor. "Typical" parameters which may be provided in ON Semiconductor data sheets and/or specifications can and do vary in different applications and actual performance may vary over time. All operating parameters, including "Typicals" must be validated for each customer application by customer's technical experts. ON Semiconductor does not convey any license under its patent rights nor the rights of others. ON Semiconductor products are not designed, intended, or authorized for use as a critical component in life support systems or any FDA Class 3 medical devices or medical devices with a same or similar classification in a foreign jurisdiction or any devices intended for implantation in the human body. Should Buyer purchase or use ON Semiconductor products for any such unintended or unauthorized application, Buyer shall indemnify and hold ON Semiconductor and its officers, employees, subsidiaries, affiliates, and distributors harmless against all claims, costs, damages, and expenses, and reasonable attorney fees arising out of, directly or indirectly, any claim of personal injury or death associated with such unintended or unauthorized use, even if such claim alleges that ON Semiconductor was negligent regarding the design or manufacture of the part. ON Semiconductor is an Equal Opportunity/Affirmative Action Employer. This literature is subject to all applicable copyright laws and is not for resale in any manner.

## PUBLICATION ORDERING INFORMATION

### LITERATURE FULFILLMENT:

Literature Distribution Center for ON Semiconductor  
19521 E. 32nd Pkwy, Aurora, Colorado 80011 USA  
**Phone:** 303-675-2175 or 800-344-3860 Toll Free USA/Canada  
**Fax:** 303-675-2176 or 800-344-3867 Toll Free USA/Canada  
**Email:** [orderlit@onsemi.com](mailto:orderlit@onsemi.com)

**N. American Technical Support:** 800-282-9855 Toll Free  
USA/Canada  
**Europe, Middle East and Africa Technical Support:**  
Phone: 421 33 790 2910  
**Japan Customer Focus Center**  
Phone: 81-3-5817-1050

**ON Semiconductor Website:** [www.onsemi.com](http://www.onsemi.com)  
**Order Literature:** <http://www.onsemi.com/orderlit>  
For additional information, please contact your local  
Sales Representative