

# TCP-4156UB

## 5.6 pF Passive Tunable Integrated Circuits (PTIC)

### Introduction

ON Semiconductor's PTICs have excellent RF performance and power consumption, making them suitable for any mobile handset or radio application. The fundamental building block of our PTIC product line is a tunable material called ParaScan™, based on Barium Strontium Titanate (BST). PTICs have the ability to change their capacitance from a supplied bias voltage generated by the Control IC. The 5.6 pF ultra-high tuning PTICs are available as wafer-level chip scale packages (WLCSP).

### Key Features

- Ultra-High Tuning Range and Operation up to 24 V
- Usable Frequency Range: from 700 MHz to 2.7 GHz
- High Quality Factor (Q) for Low Loss
- High Power Handling Capability
- Compatible with PTIC Control IC TCC-10x, 20x
- WLCSP Package: 0.609 x 1.009 x 0.310 mm (4 bump)
- These devices are Pb-Free and RoHS Compliant

### Typical Applications

- Multi-band, Multi-standard, Advanced and Simple Mobile Phones
- Tunable Antenna Matching Networks
- Tunable RF Filters
- Active Antennas



ON Semiconductor®

[www.onsemi.com](http://www.onsemi.com)



WLCSP4  
1.009x0.609  
CASE 567LZ

### MARKING DIAGRAM

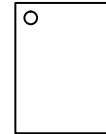

### FUNCTIONAL BLOCK DIAGRAM

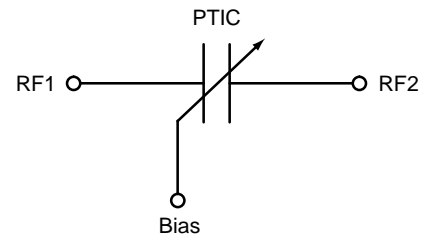

PTIC Functional Block Diagram

### ORDERING INFORMATION

Device	Package	Shipping†
TCP-4156UB-DT	WLCSP4 (Pb-Free)	4000 Units / 7" Tape & Reel

†For information on tape and reel specifications, including part orientation and tape sizes, please refer to our Tape and Reel Packaging Specifications Brochure, BRD8011/D.

TCP-4156UB

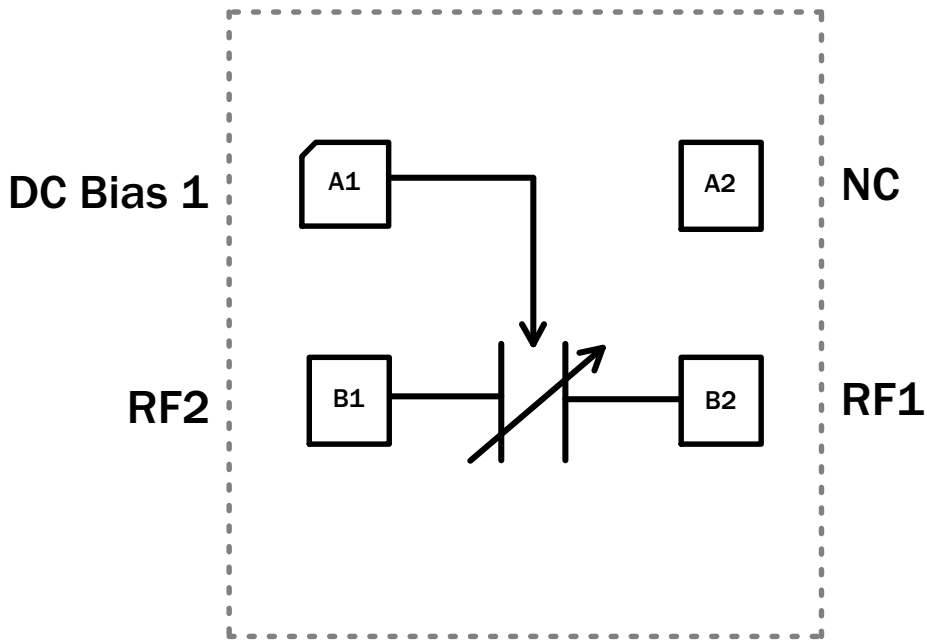

Figure 1. PTIC Functional Block Diagram

Table 1. SIGNAL DESCRIPTIONS

Ball / Pad Number	Pin Name	Description
A1	DC Bias 1	DC Bias Voltage
B1	RF2	RF Input / Output
A2	NC	Not Connected
B2	RF1	RF Input / Output

# TCP-4156UB

## TYPICAL SPECIFICATIONS

### Representative Performance Data at 25°C

**Table 2. PERFORMANCE DATA**

Parameter	Min	Typ	Max	Units
Operating Bias Voltage	1.0		24	V
Capacitance ( $V_{bias} = 2\text{ V}$ )	5.04	5.60	6.16	pF
Capacitance ( $V_{bias} = 24\text{ V}$ )	1.072	1.191	1.311	pF
Tuning Range (1 V - 24 V)	4.80	5.30	6.00	
Tuning Range (2 V - 24 V)	4.20	4.70	5.30	
Leakage Current (WLCSP)			0.5	$\mu\text{A}$
Operating Frequency	700		2700	MHz
Quality Factor @ 700 MHz, 10 V		100		
Quality Factor @ 2.4 GHz, 10 V		65		
IP3 ( $V_{bias} = 2\text{ V}$ ) [1,3]		70		dBm
IP3 ( $V_{bias} = 24\text{ V}$ ) [1,3]		85		dBm
2nd Harmonic ( $V_{bias} = 2\text{ V}$ ) [2,3]		-70		dBm
2nd Harmonic ( $V_{bias} = 24\text{ V}$ ) [2,3]		-80		dBm
3rd Harmonic ( $V_{bias} = 2\text{ V}$ ) [2,3]		-40		dBm
3rd Harmonic ( $V_{bias} = 24\text{ V}$ ) [2,3]		-70		dBm
Transition Time (Cmin $\rightarrow$ Cmax) [4]		80		$\mu\text{s}$
Transition Time (Cmax $\rightarrow$ Cmin) [4]		70		$\mu\text{s}$

1.  $f_1 = 850\text{ MHz}$ ,  $f_2 = 860\text{ MHz}$ , Pin 25 dBm/Tone
2. 850 MHz, Pin +34 dBm
3. IP3 and Harmonics are measured in the shunt configuration in a 50  $\Omega$  environment
4. RF<sub>IN</sub> and RF<sub>OUT</sub> are both connected to DC ground

# TCP-4156UB

## Representative performance data at 25°C for 5.6 pF WLCSP Package

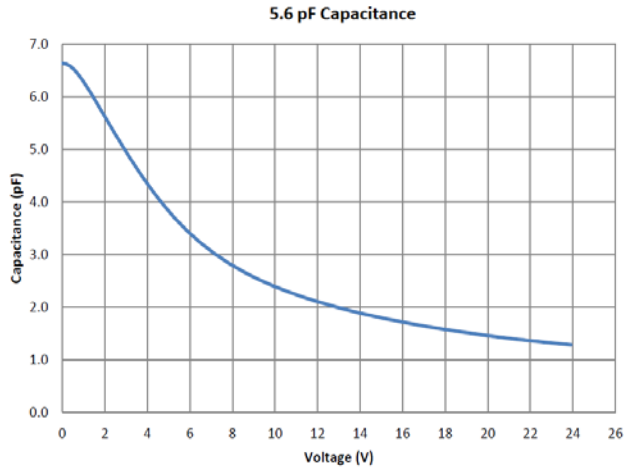

Figure 2. Capacitance

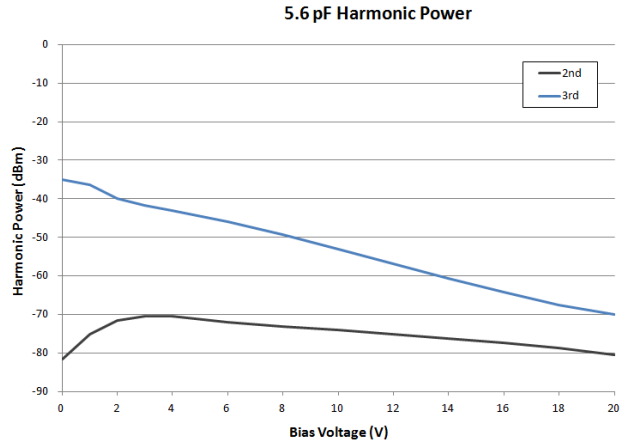

Figure 3. Harmonic Power\*

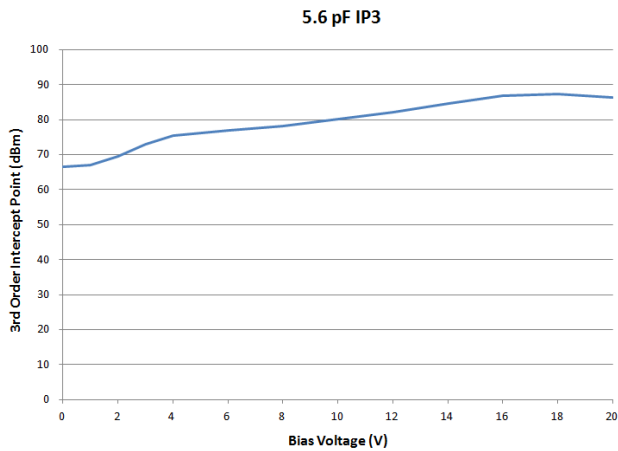

Figure 4. IP3\*

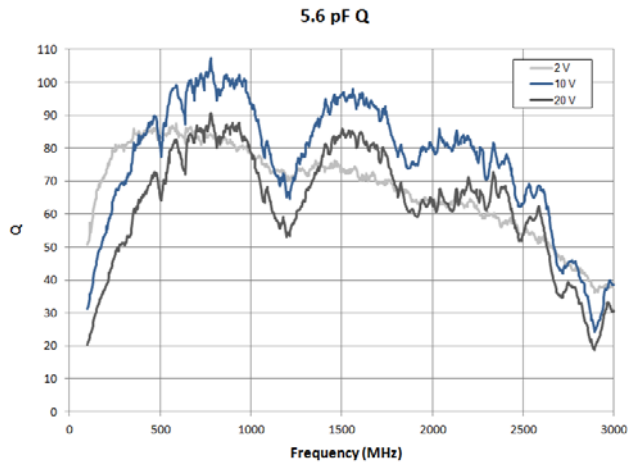

Figure 5. Q\*

\*Data shown is representative only.

Table 3. ABSOLUTE MAXIMUM RATINGS

Parameter	Rating	Units
Input Power	+40	dBm
Bias Voltage	+25 (Note 5)	V
Operating Temperature Range	-30 to +85	°C
Storage Temperature Range	-55 to +125	°C
ESD – Human Body Model	Class 1B JEDEC HBM Standard (Note 6)	

Stresses exceeding those listed in the Maximum Ratings table may damage the device. If any of these limits are exceeded, device functionality should not be assumed, damage may occur and reliability may be affected.

5. WLCSP: Recommended Bias Voltage not to exceed 24 V.

6. Class 1B defined as passing 500 V, but may fail after exposure to 1000 V ESD pulse.

**ASSEMBLY CONSIDERATIONS AND REFLOW PROFILE**

The following assembly considerations should be observed:

**Cleanliness**

These chips should be handled in a clean environment.

**Electro-static Sensitivity**

ON Semiconductor’s PTICs are ESD Class 1B sensitive. The proper ESD handling procedures should be used.

**Mounting**

The WLCSP PTIC is fabricated for Flip Chip solder mounting. Connectivity to the RF and Bias terminations on the PTIC die is established through SAC305 solder balls with 65 μm nominal height (45 μm to 85 μm height variation). The PTIC die is RoHS-compliant and compatible with lead-free soldering profile.

**Molding**

The PTIC die is compatible for over-molding or under-fill.

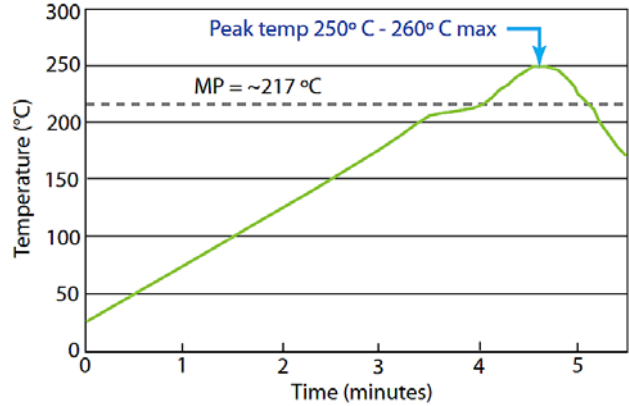

*This reflow profile is a guideline for Pb-free solder materials. Adjustments to this profile are necessary based on specific process requirements and board size, thickness and density. Not to exceed 260° C for 5 seconds.*

**Figure 6. Reflow Profile**

**ORIENTATION OF THE PTIC FOR OPTIMUM LOSSES**

When configuring the PTIC in your specific circuit design, at least one of the RF terminals must be connected to DC ground. If minimum transition times are required, DC ground on both RF terminals is recommended. To minimize losses, the PTIC should be oriented such that RF2 is at the lower RF impedance of the two RF nodes. A shunt PTIC, for example, should have RF2 connected to RF ground.

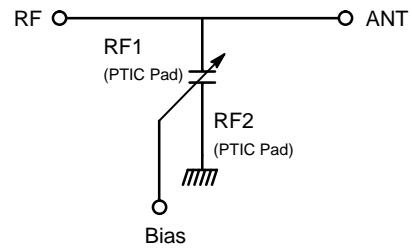

**Figure 7. PTIC Orientation Functional Block Diagram**

# TCP-4156UB

## PART NUMBER DEFINITION

**Table 4. PART NUMBERS**

Part Number	Capacitance		Package*
	2 V	24 V	
TCP-4156UB-DT	5.60	1.244	4-bump WLCSP

\*See PTIC package dimensions on following page.

For information on device numbering and ordering codes, please download the *Device Nomenclature* technical note (TND310/D) from [www.onsemi.com](http://www.onsemi.com).

# TCP-4156UB

## PACKAGE DIMENSIONS

WLCSP4, 1.009x0.609  
CASE 567LZ  
ISSUE O

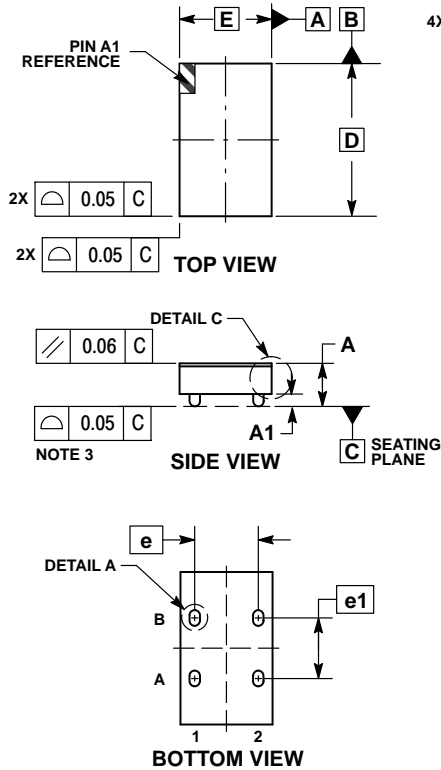

### NOTES:

1. DIMENSIONING AND TOLERANCING PER ASME Y14.5M, 1994.
2. CONTROLLING DIMENSION: MILLIMETERS.
3. COPLANARITY APPLIES TO SPHERICAL CROWNS OF SOLDER BALLS.
4. BACKSIDE TAPE APPLIED TO IMPROVE PIN 1 MARKING.

DIM	MILLIMETERS	
	MIN	MAX
A	0.275	0.345
A1	0.045	0.085
b	0.079	0.129
b1	0.044	0.094
D	1.009 BSC	
E	0.609 BSC	
e	0.420 BSC	
e1	0.400 BSC	

### RECOMMENDED SOLDERING FOOTPRINT\*

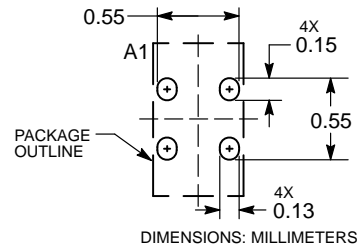

\*For additional information on our Pb-Free strategy and soldering details, please download the ON Semiconductor Soldering and Mounting Techniques Reference Manual, SOLDERRM/D.

ParaScan is a trademark of Paratek Microwave, Inc.

ON Semiconductor and are trademarks of Semiconductor Components Industries, LLC dba ON Semiconductor or its subsidiaries in the United States and/or other countries. ON Semiconductor owns the rights to a number of patents, trademarks, copyrights, trade secrets, and other intellectual property. A listing of ON Semiconductor's product/patent coverage may be accessed at [www.onsemi.com/site/pdf/Patent-Marketing.pdf](http://www.onsemi.com/site/pdf/Patent-Marketing.pdf). ON Semiconductor reserves the right to make changes without further notice to any products herein. ON Semiconductor makes no warranty, representation or guarantee regarding the suitability of its products for any particular purpose, nor does ON Semiconductor assume any liability arising out of the application or use of any product or circuit, and specifically disclaims any and all liability, including without limitation special, consequential or incidental damages. Buyer is responsible for its products and applications using ON Semiconductor products, including compliance with all laws, regulations and safety requirements or standards, regardless of any support or applications information provided by ON Semiconductor. "Typical" parameters which may be provided in ON Semiconductor data sheets and/or specifications can and do vary in different applications and actual performance may vary over time. All operating parameters, including "Typicals" must be validated for each customer application by customer's technical experts. ON Semiconductor does not convey any license under its patent rights nor the rights of others. ON Semiconductor products are not designed, intended, or authorized for use as a critical component in life support systems or any FDA Class 3 medical devices or medical devices with a same or similar classification in a foreign jurisdiction or any devices intended for implantation in the human body. Should Buyer purchase or use ON Semiconductor products for any such unintended or unauthorized application, Buyer shall indemnify and hold ON Semiconductor and its officers, employees, subsidiaries, affiliates, and distributors harmless against all claims, costs, damages, and expenses, and reasonable attorney fees arising out of, directly or indirectly, any claim of personal injury or death associated with such unintended or unauthorized use, even if such claim alleges that ON Semiconductor was negligent regarding the design or manufacture of the part. ON Semiconductor is an Equal Opportunity/Affirmative Action Employer. This literature is subject to all applicable copyright laws and is not for resale in any manner.

### PUBLICATION ORDERING INFORMATION

**LITERATURE FULFILLMENT:**  
Literature Distribution Center for ON Semiconductor  
19521 E. 32nd Pkwy, Aurora, Colorado 80011 USA  
**Phone:** 303-675-2175 or 800-344-3860 Toll Free USA/Canada  
**Fax:** 303-675-2176 or 800-344-3867 Toll Free USA/Canada  
**Email:** [orderlit@onsemi.com](mailto:orderlit@onsemi.com)

**N. American Technical Support:** 800-282-9855 Toll Free  
USA/Canada  
**Europe, Middle East and Africa Technical Support:**  
Phone: 421 33 790 2910

**ON Semiconductor Website:** [www.onsemi.com](http://www.onsemi.com)  
**Order Literature:** <http://www.onsemi.com/orderlit>

For additional information, please contact your local Sales Representative