

TCP-5168UA

Product Preview

High-Linearity 6.8 pF Passive Tunable Integrated Circuits (PTIC)

Introduction

ON Semiconductor's PTICs have excellent RF performance and power consumption, making them suitable for any mobile handset or radio application. The fundamental building block of our PTIC product line is a tunable material called ParaScan™, based on Barium Strontium Titanate (BST). PTICs have the ability to change their capacitance from a supplied bias voltage generated by the Control IC. TCP-5168UA has higher linearity for use in applications which require improved harmonic performance. The 6.8 pF ultra-high tuning, high Q PTICs are available as wafer-level chip scale packages (WLCSP).

Key Features

- Ultra-High Tuning Range (5:1) and Operation up to 24 V
- Usable Frequency Range: from 700 MHz to 2.7 GHz
- High Quality Factor (Q) for Low Loss
- High Power Handling Capability
- Compatible with PTIC Control ICs from ON Semiconductor
- These devices are Pb-Free and RoHS Compliant

Typical Applications

- Multi-band, Multi-standard, Advanced and Simple Mobile Phones
- Tunable Antenna Matching Networks
- Tunable RF Filters
- Active Antennas

This document contains information on a product under development. ON Semiconductor reserves the right to change or discontinue this product without notice.



ON Semiconductor®

www.onsemi.com



WLCSP3
0.772x0.993
CASE 567WS

MARKING DIAGRAM



h = Specific Device Code
Y = Year
W = Work Week

Pin#1 marking can be either dot or bar

FUNCTIONAL BLOCK DIAGRAM

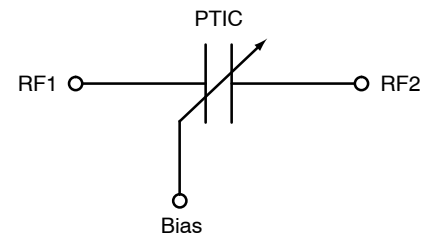

PTIC Functional Block Diagram

ORDERING INFORMATION

Device	Package	Shipping†
TCP-5168UA-DT	WLCSP3 (Pb-Free)	7000 Units / 7" Tape & Reel

†For information on tape and reel specifications, including part orientation and tape sizes, please refer to our Tape and Reel Packaging Specifications Brochure, BRD8011/D.

TCP-5168UA

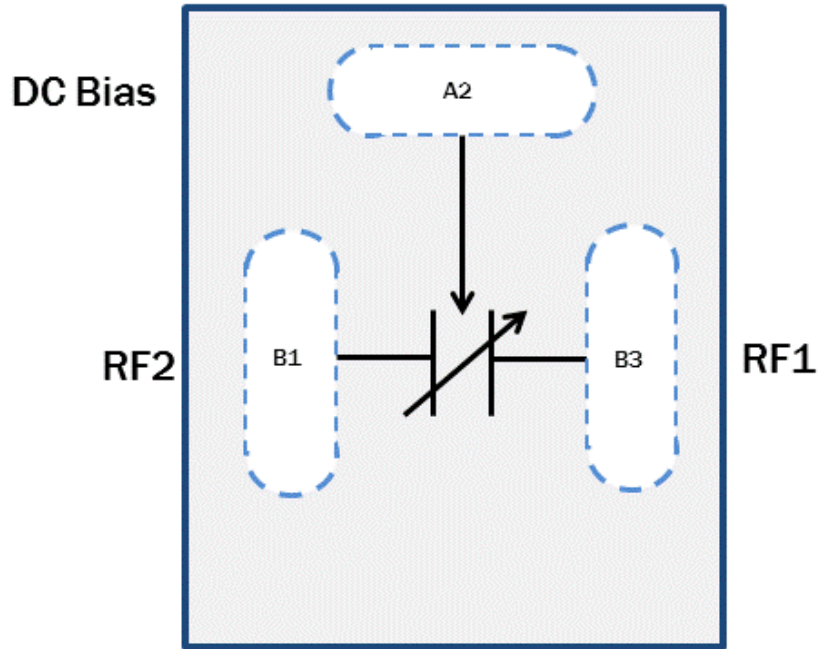

Figure 1. PTIC Functional Block Diagram (Top View)

Table 1. SIGNAL DESCRIPTIONS

Ball / Pad Number	Pin Name	Description
A2	DC Bias 1	DC Bias Voltage
B3	RF1	RF Input
B1	RF2	RF Output

TCP-5168UA

TYPICAL SPECIFICATIONS

Representative Performance Data at 25°C

Table 2. PERFORMANCE DATA

Parameter	Min	Typ	Max	Units
Operating Bias Voltage	1.0		24	V
Capacitance ($V_{\text{bias}} = 2 \text{ V}$)	6.19	6.80	7.41	pF
Capacitance ($V_{\text{bias}} = 24 \text{ V}$)	1.21	1.33	1.45	pF
Capacitance Accuracy ($V_{\text{bias}} = 2\text{--}24 \text{ V}$)		9		%
Tuning Range (2 V - 24 V)	4.5	5.1	5.5	
Leakage Current ($V_{\text{bias}} = 24 \text{ V}$)			4.0	μA
Operating Frequency	700		2700	MHz
Quality Factor @ 700 MHz, 2 V (Note 4)	50	60		
Quality Factor @ 700 MHz, 24 V (Note 4)	65	80		
Quality Factor @ 2.7 GHz, 2 V (Note 4)	20	30		
Quality Factor @ 2.7 GHz, 24 V (Note 4)	17	25		
IP3 ($V_{\text{bias}} = 2 \text{ V}$) (Notes 1, 3, 4)		70		dBm
IP3 ($V_{\text{bias}} = 24 \text{ V}$) (Notes 1, 3, 4)		85		dBm
2nd Harmonic ($V_{\text{bias}} = 2 \text{ V}$) (Notes 2, 3, 4)		-78	-70	dBm
2nd Harmonic ($V_{\text{bias}} = 24 \text{ V}$) (Notes 2, 3, 4)		-80	-73	dBm
3rd Harmonic ($V_{\text{bias}} = 2 \text{ V}$) (Notes 2, 3, 4)		-63	-58	dBm
3rd Harmonic ($V_{\text{bias}} = 24 \text{ V}$) (Notes 2, 3, 4)		-81	-77	dBm
Transition Time (Cmin \rightarrow Cmax) (Note 5)		66		μs
Transition Time (Cmax \rightarrow Cmin) (Note 5)		48		μs

1. $f_1 = 850 \text{ MHz}$, $f_2 = 860 \text{ MHz}$, Pin 25 dBm/Tone
2. 900 MHz, Pin + 23 dBm
3. Harmonics are measured in the reflect configuration in a 50 Ω environment
4. Sample testing only. RF_{IN} and RF_{OUT} must be connected to DC ground.
5. Sample testing only. PTIC Control IC Turbo Mode must be used.

TCP-5168UA

Representative performance data at 25°C for 6.8 pF WLCSP Package

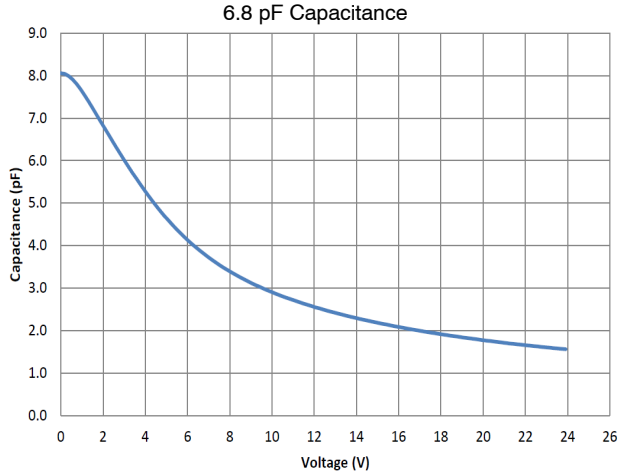

Figure 2. Capacitance

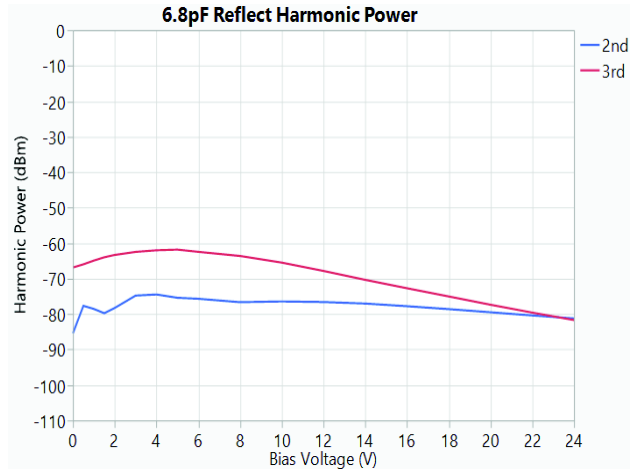

Figure 3. Harmonic Power*

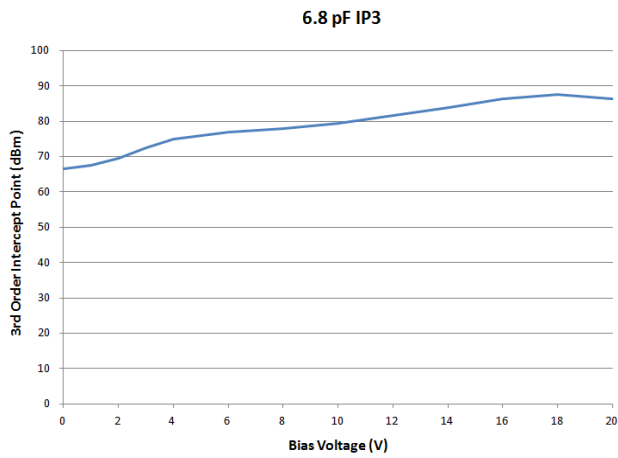

Figure 4. IP3*

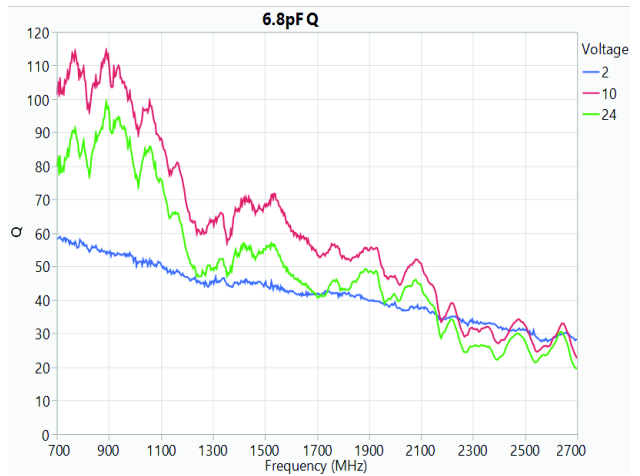

Figure 5. Q*

*Data shown is representative only.

Table 3. ABSOLUTE MAXIMUM RATINGS

Parameter	Rating	Units
Input Power	+40	dBm
Bias Voltage	+30 (Note 6)	V
Operating Temperature Range	-30 to +85	°C
Storage Temperature Range	-55 to +125	°C
ESD – Human Body Model	Class 1B JEDEC HBM Standard (Note 7)	

Stresses exceeding those listed in the Maximum Ratings table may damage the device. If any of these limits are exceeded, device functionality should not be assumed, damage may occur and reliability may be affected.

6. WLCSP: Recommended Bias Voltage not to exceed 24 V.

7. Class 1B defined as passing 500 V, but may fail after exposure to 1000 V ESD pulse.

ASSEMBLY CONSIDERATIONS AND REFLOW PROFILE

The following assembly considerations should be observed:

Cleanliness

These chips should be handled in a clean environment.

Electro-static Sensitivity

ON Semiconductor’s PTICs are ESD Class 1B sensitive. The proper ESD handling procedures should be used.

Mounting

The WLCSP PTIC is fabricated for Flip Chip solder mounting. Connectivity to the RF and Bias terminations on the PTIC die is established through SAC305 solder balls with 90 μm nominal height (65 μm to 115 μm height variation). The PTIC die is RoHS-compliant and compatible with lead-free soldering profile.

Molding

The PTIC die is compatible for over-molding or under-fill.

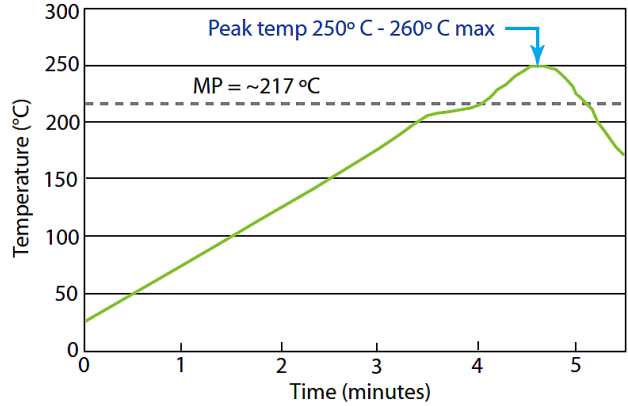

This reflow profile is a guideline for Pb-free solder materials. Adjustments to this profile are necessary based on specific process requirements and board size, thickness and density. Not to exceed 260° C for 5 seconds.

Figure 6. Reflow Profile

ORIENTATION OF THE PTIC FOR OPTIMUM LOSSES

When configuring the PTIC in your specific circuit design, at least one of the RF terminals must be connected to DC ground. If minimum transition times are required, DC ground on both RF terminals is recommended. To minimize losses, the PTIC should be oriented such that RF2 is at the lower RF impedance of the two RF nodes. A shunt PTIC, for example, should have RF2 connected to RF ground.

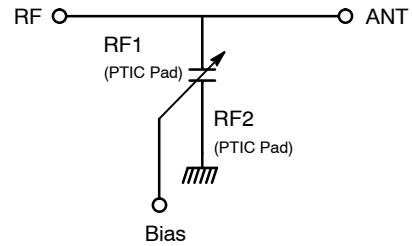

Figure 7. PTIC Orientation Functional Block Diagram

TCP-5168UA

PART NUMBER DEFINITION

Table 4. PART NUMBERS

Part Number	Capacitance		Marking		Package*
	2 V	24 V	Device ID	Trace Code	
TCP-5168UA-DT	6.80	1.33	h	YW**	3-bump WLCSP

*See PTIC package dimensions on following page.

**Refer to table below (Table 5) for YW trace code.

For information on device numbering and ordering codes, please download the *Device Nomenclature* technical note (TND310/D) from www.onsemi.com.

Table 5. Two Digits Year and Work Week Date coding (YW) – In Process Product / Traceability Date Code Marking

Code	Term	Definition								
YW	Year and Work Week	Two-character Alpha Code. Example: 2005, workweek 10 = GJ								
		YEAR	WORK WEEK	CODE	YEAR	WORK WEEK	CODE	YEAR	WORK WEEK	CODE
		2003	1	CA	2004	1	EA	2005	1	GA
			26	CZ		26	EZ		26	GZ
			27	DA		27	FA		27	HA
			52	DZ		52	FZ		52	HZ
		2006	1	IA	2007	1	KA	2008	1	MA
			26	IZ		26	KZ		26	MZ
			27	JA		27	LA		27	NA
			52	JZ		52	LZ		52	NZ
		2009	1	PA	2010	1	SA	2011	1	UA
			26	PZ		26	SZ		26	UZ
			27	RA		27	TA		27	VA
			52	RZ		52	TZ		52	VZ
		2012	1	WA	2013	1	YA	2014	1	AA
			26	WZ		26	YZ		26	AZ
			27	XA		27	ZA		27	BA
			52	XZ		52	ZZ		52	BZ
		2015	1	CA	2016	1	EA	2017	1	GA
			26	CZ		26	EZ		26	GZ
			27	DA		27	FA		27	HA
			52	DZ		52	FZ		52	HZ

For dates outside of the table: the first character of the code is incremented at the start of workweek 01 and workweek 27 each year. The second character begins with “A” in workweek 01 of each year and increments weekly. “A” follows “Z” to make the code continuous.

TCP-5168UA

PACKAGE DIMENSIONS

WLCSP3, 0.993x0.772
CASE 567WS
ISSUE O

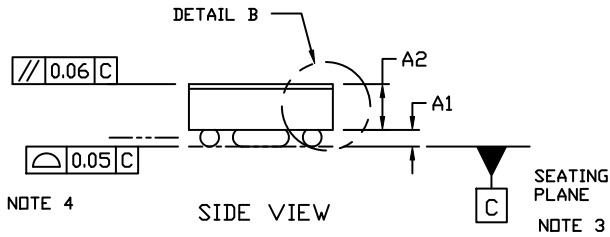
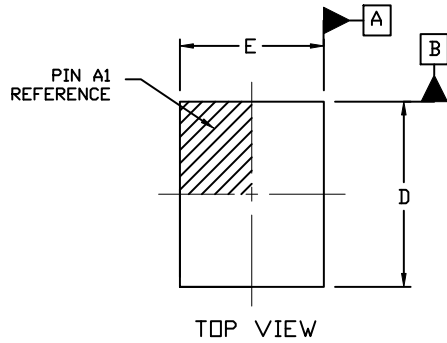

NOTES:

1. DIMENSIONING AND TOLERANCING PER ASME Y14.5M, 1994.
2. CONTROLLING DIMENSION: MILLIMETERS
3. DATUM C, THE SEATING PLANE, IS DEFINED BY THE SPHERICAL CROWNS OF THE CONTACTS.
4. COPLANARITY APPLIES TO THE SPHERICAL CROWNS OF THE CONTACTS.
5. DIMENSIONS b AND b_1 ARE MEASURED AT THE MAXIMUM CONTACT DIAMETER PARALLEL TO DATUM C. POSITIONAL TOLERANCE APPLIES TO ALL THREE CONTACTS IN BOTH THE X AND Y AXIS.
6. BACKSIDE TAPE APPLIED TO IMPROVE PIN 1 MARKING.

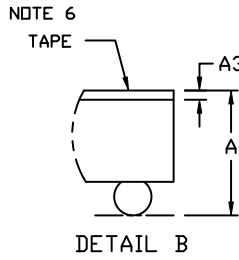

DIM	MILLIMETERS		
	MIN.	NDM.	MAX.
A	0.295	0.335	0.375
A1	0.065	0.090	0.115
A2	0.260 REF		
A3	0.025 REF		
b	0.275	0.300	0.325
b_1	0.075	0.100	0.125
D	0.943	0.993	1.043
E	0.722	0.772	0.822
e	0.550 BSC		
e_2	0.377 BSC		
e_3	0.048 BSC		

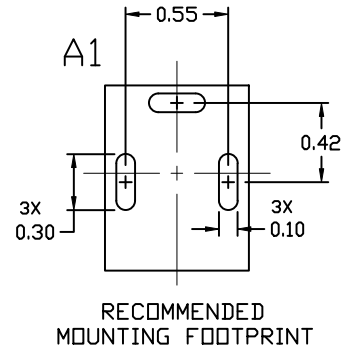
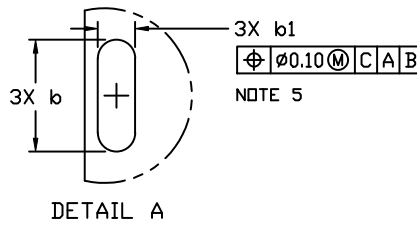
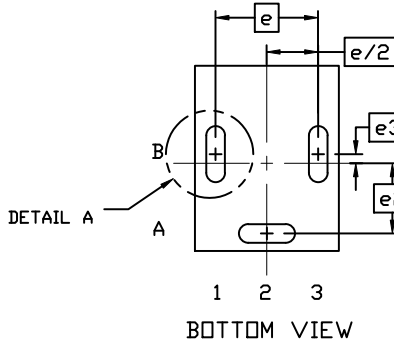

ParaScan is a trademark of Paratek Microwave, Inc.

ON Semiconductor and  are trademarks of Semiconductor Components Industries, LLC dba ON Semiconductor or its subsidiaries in the United States and/or other countries. ON Semiconductor owns the rights to a number of patents, trademarks, copyrights, trade secrets, and other intellectual property. A listing of ON Semiconductor's product/patent coverage may be accessed at www.onsemi.com/site/pdf/Patent-Marking.pdf. ON Semiconductor reserves the right to make changes without further notice to any products herein. ON Semiconductor makes no warranty, representation or guarantee regarding the suitability of its products for any particular purpose, nor does ON Semiconductor assume any liability arising out of the application or use of any product or circuit, and specifically disclaims any and all liability, including without limitation special, consequential or incidental damages. Buyer is responsible for its products and applications using ON Semiconductor products, including compliance with all laws, regulations and safety requirements or standards, regardless of any support or applications information provided by ON Semiconductor. "Typical" parameters which may be provided in ON Semiconductor data sheets and/or specifications can and do vary in different applications and actual performance may vary over time. All operating parameters, including "Typicals" must be validated for each customer application by customer's technical experts. ON Semiconductor does not convey any license under its patent rights nor the rights of others. ON Semiconductor products are not designed, intended, or authorized for use as a critical component in life support systems or any FDA Class 3 medical devices or medical devices with a same or similar classification in a foreign jurisdiction or any devices intended for implantation in the human body. Should Buyer purchase or use ON Semiconductor products for any such unintended or unauthorized application, Buyer shall indemnify and hold ON Semiconductor and its officers, employees, subsidiaries, affiliates, and distributors harmless against all claims, costs, damages, and expenses, and reasonable attorney fees arising out of, directly or indirectly, any claim of personal injury or death associated with such unintended or unauthorized use, even if such claim alleges that ON Semiconductor was negligent regarding the design or manufacture of the part. ON Semiconductor is an Equal Opportunity/Affirmative Action Employer. This literature is subject to all applicable copyright laws and is not for resale in any manner.

PUBLICATION ORDERING INFORMATION

LITERATURE FULFILLMENT:

Literature Distribution Center for ON Semiconductor
P.O. Box 5163, Denver, Colorado 80217 USA
Phone: 303-675-2175 or 800-344-3860 Toll Free USA/Canada
Fax: 303-675-2176 or 800-344-3867 Toll Free USA/Canada
Email: orderlit@onsemi.com

N. American Technical Support: 800-282-9855 Toll Free
USA/Canada
Europe, Middle East and Africa Technical Support:
Phone: 421 33 790 2910

ON Semiconductor Website: www.onsemi.com

Order Literature: <http://www.onsemi.com/orderlit>

For additional information, please contact your local Sales Representative