

TVS8814, TVS8818

Transient Voltage Suppressors

Low Capacitance TVS Protection for High Speed Data

The TVS8814 and TVS8818 transient voltage suppressors are designed specifically to protect 10/100 and GbE Ethernet signals from high levels of surge current. Low clamping voltage under high surge conditions make this device an ideal solution for protecting voltage sensitive lines leading to Ethernet transceiver chips. Low capacitance combined with flow-through style packaging allows for easy PCB layout and matched trace lengths necessary to maintain consistent impedance between high-speed differential lines. The integrated 4 and 8 lines of protection in flow-thru type packages offer a simplified solution with premier performance for 10/100 and GbE Ethernet applications.

Features

- Protection for the Following IEC Standards:
 - IEC 61000-4-2 (ESD) ± 30 kV (Contact)
 - IEC 61000-4-5 (Lightning) 35 A (8/20 μ s)
- Flow-Thru Routing Scheme
- 2 pF Max, I/O to I/O
- UL Flammability Rating of 94 V-0
- This is a Pb-Free Device

Typical Applications

- 10/100 and GbE Ethernet
- MagJacks® / Integrated Magnetics
- Notebooks/Desktops/Servers

MAXIMUM RATINGS ($T_J = 25^\circ\text{C}$ unless otherwise noted)

Rating	Symbol	Value	Unit
Operating Junction Temperature Range	T_J	-55 to +125	$^\circ\text{C}$
Storage Temperature Range	T_{stg}	-55 to +150	$^\circ\text{C}$
Lead Solder Temperature – Maximum (10 Seconds)	T_L	260	$^\circ\text{C}$
IEC 61000-4-2 Contact (ESD) IEC 61000-4-2 Air (ESD)	ESD	± 30 ± 30	kV kV
Maximum Peak Pulse Current 8/20 μ s @ $T_A = 25^\circ\text{C}$ 10/700 μ s @ $T_A = 25^\circ\text{C}$	I_{PP}	35 20	A

Stresses exceeding those listed in the Maximum Ratings table may damage the device. If any of these limits are exceeded, device functionality should not be assumed, damage may occur and reliability may be affected.

See Application Note AND8308/D for further description of survivability specs.



ON Semiconductor®

www.onsemi.com

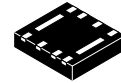

UDFN8
CASE 506CV

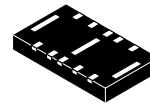

UDFN10
CASE 506CU

MARKING DIAGRAMS

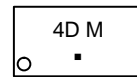

- XX = Specific Device Code
- M = Date Code
- = Pb-Free Package

ORDERING INFORMATION

Device	Package	Shipping
TVS8814MUTAG	UDFN8 (Pb-Free)	3000 / Tape & Reel
TVS8818MUTAG	UDFN10 (Pb-Free)	3000 / Tape & Reel

†For information on tape and reel specifications, including part orientation and tape sizes, please refer to our Tape and Reel Packaging Specification Brochure, BRD8011/D.

TVS8814, TVS8818

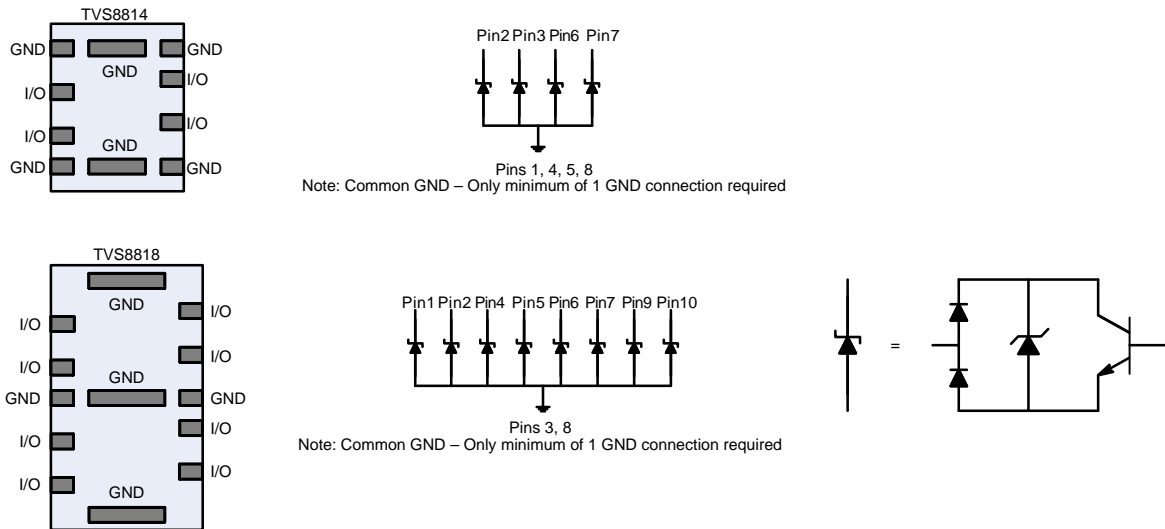
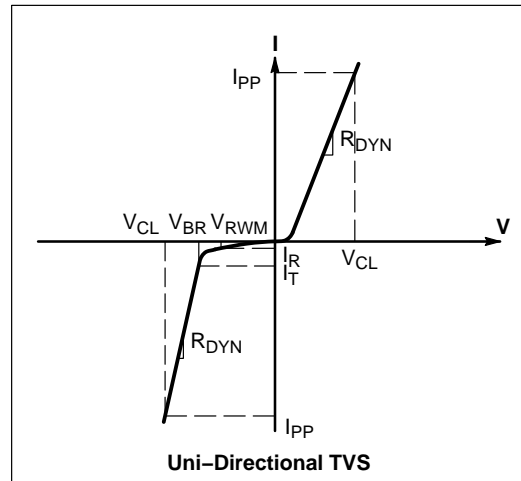

Figure 1. Pin Schematic

ELECTRICAL CHARACTERISTICS

($T_A = 25^\circ\text{C}$ unless otherwise noted)

Symbol	Parameter
V_{RWM}	Working Peak Voltage
I_R	Maximum Reverse Leakage Current @ V_{RWM}
V_{BR}	Breakdown Voltage @ I_T
I_T	Test Current
V_{HOLD}	Holding Reverse Voltage
I_{HOLD}	Holding Reverse Current
R_{DYN}	Dynamic Resistance
I_{PP}	Maximum Peak Pulse Current
V_C	Clamping Voltage @ I_{PP} $V_C = V_{HOLD} + (I_{PP} * R_{DYN})$



ELECTRICAL CHARACTERISTICS ($T_A = 25^\circ\text{C}$ unless otherwise specified)

Parameter	Symbol	Conditions	Min	Typ	Max	Unit
Reverse Working Voltage	V_{RWM}	Any I/O to GND (Note 1)			3.0	V
Forward Voltage	V_F	$I_F = 10 \text{ mA}$, GND to All IO Pins	0.5	0.85	1.1	V
Breakdown Voltage	V_{BR}	$I_T = 1 \text{ mA}$, I/O to GND	3.2	3.5	5.0	V
Reverse Leakage Current	I_R	$V_{RWM} = 3.0 \text{ V}$, I/O to GND			0.5	μA
Clamping Voltage	V_C	$I_{PP} = 1 \text{ A}$, Any I/O to GND (8/20 μs pulse)			5.0	V
Clamping Voltage	V_C	$I_{PP} = 10 \text{ A}$, Any I/O to GND (8/20 μs pulse)			6.0	V
Clamping Voltage	V_C	$I_{PP} = 25 \text{ A}$, Any I/O to GND (8/20 μs pulse)			10	V
Clamping Voltage	V_C	$I_{PP} = 35 \text{ A}$, Any I/O to GND (8/20 μs pulse)			15	V
Clamping Voltage	V_C	IEC61000-4-2, $\pm 8 \text{ kV}$ Contact	See Figures 7 and 8			V
Junction Capacitance	C_J	$V_R = 0 \text{ V}$, $f = 1 \text{ MHz}$ between I/O Pins		1.5	2.0	pF
Junction Capacitance	C_J	$V_R = 0 \text{ V}$, $f = 1 \text{ MHz}$ between I/O Pins and GND			5.0	pF

Product parametric performance is indicated in the Electrical Characteristics for the listed test conditions, unless otherwise noted. Product performance may not be indicated by the Electrical Characteristics if operated under different conditions.

1. TVS devices are normally selected according to the working peak reverse voltage (V_{RWM}), which should be equal or greater than the DC or continuous peak operating voltage level.

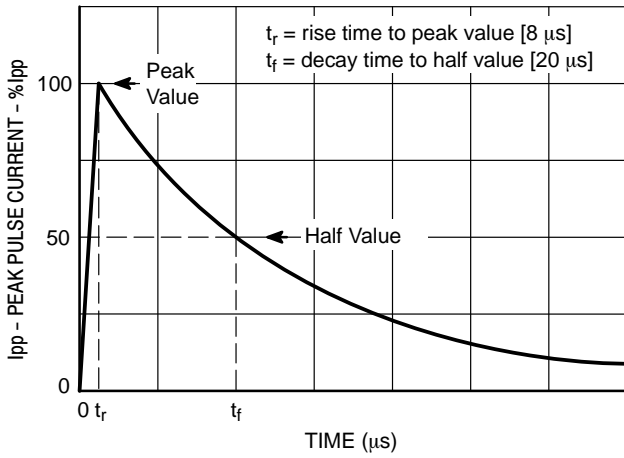

Figure 2. IEC61000-4-5 8/20 μ s Pulse Waveform

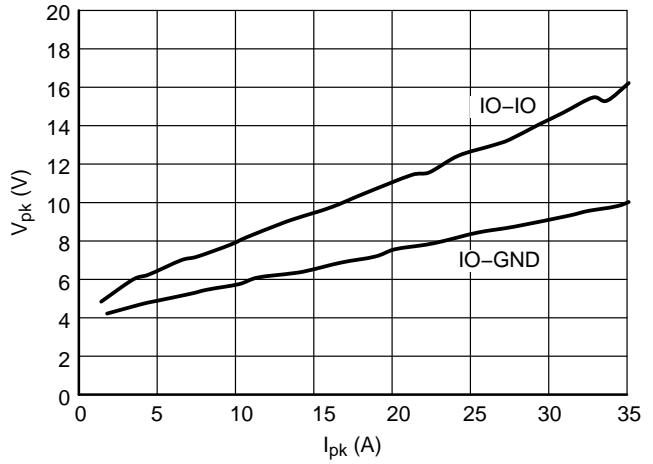

Figure 3. Clamping Voltage vs. Peak Pulse Current ($t_p = 8/20 \mu$ s per Figure 2)

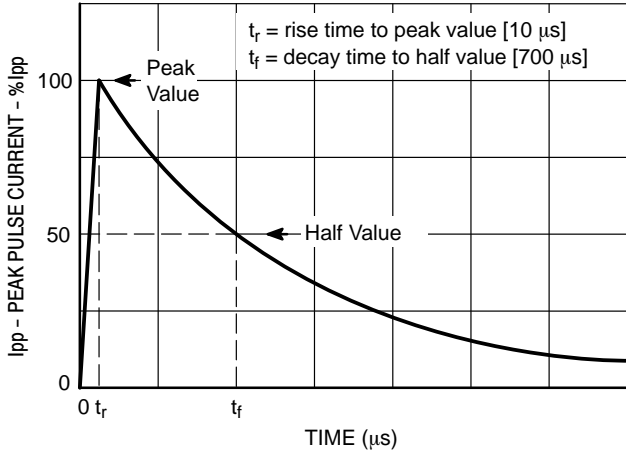

Figure 4. IEC61000-4-5 10/700 μ s Pulse Waveform

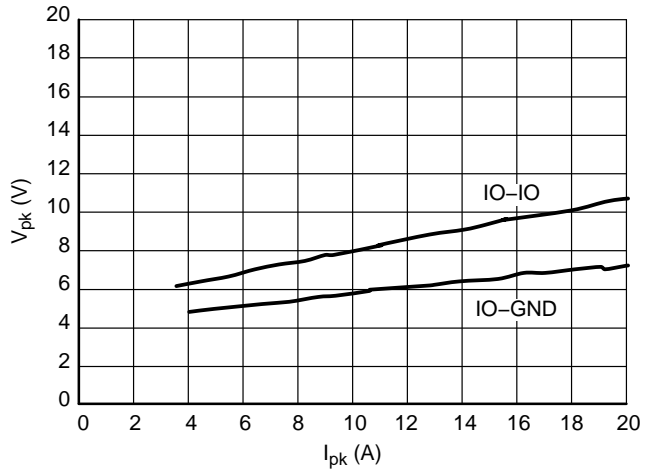

Figure 5. Clamping Voltage vs. Peak Pulse Current ($t_p = 10/700 \mu$ s per Figure 4)

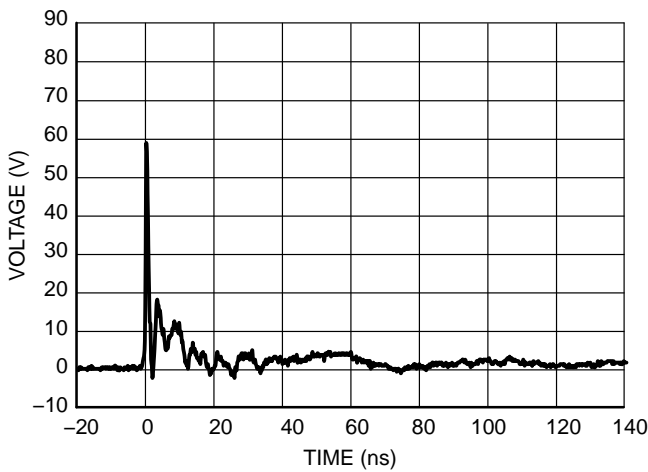

Figure 6. IEC61000-2-4 +8 kV Contact Clamping Voltage

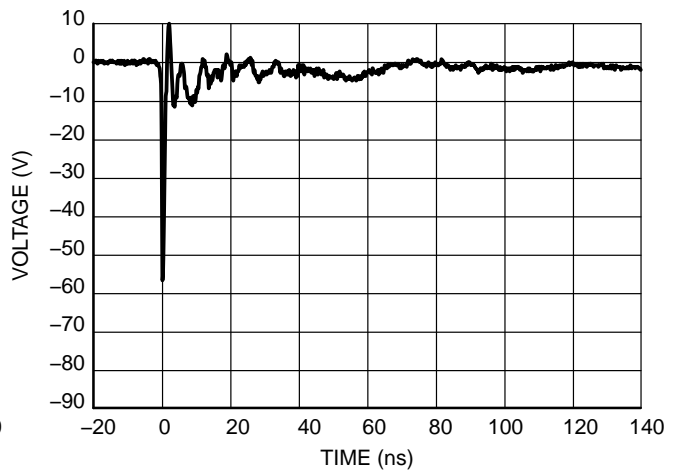

Figure 7. IEC61000-2-4 -8 kV Contact Clamping Voltage

TVS8814, TVS8818

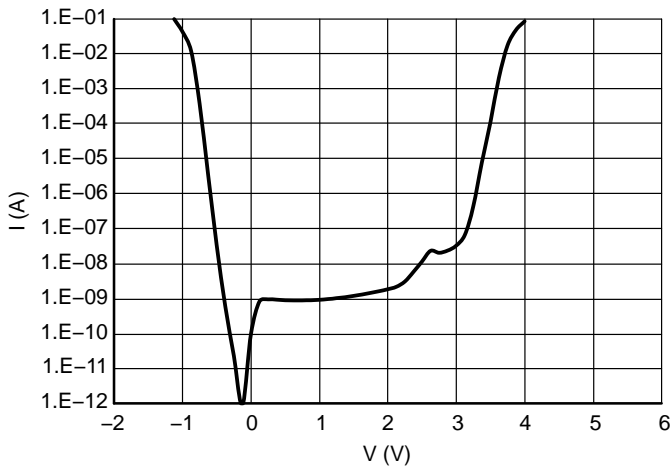

Figure 8. IV Characteristics

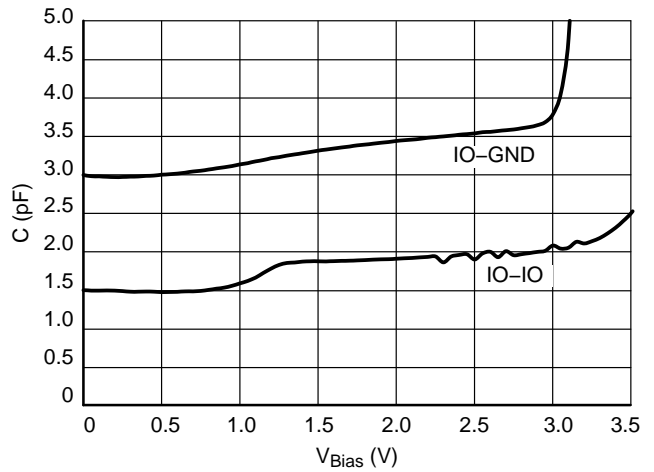

Figure 9. CV Characteristics

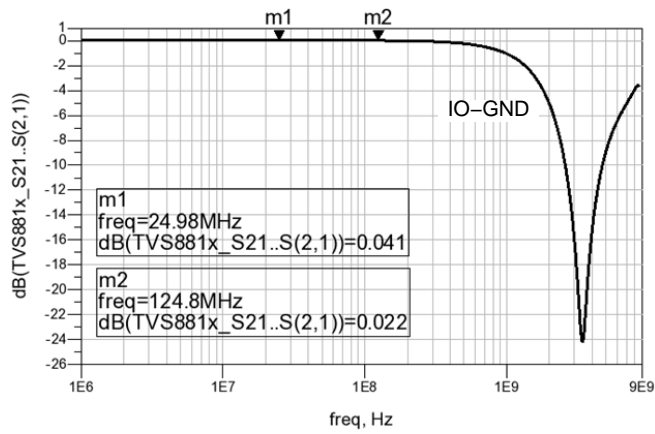

Figure 10. RF Insertion Loss

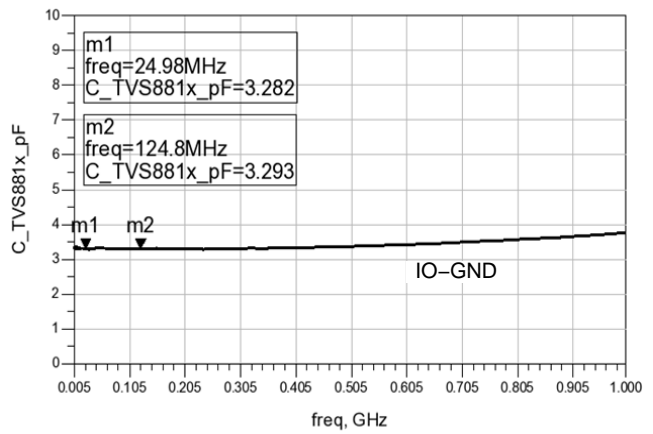

Figure 11. Capacitance Over Frequency

TVS8814, TVS8818

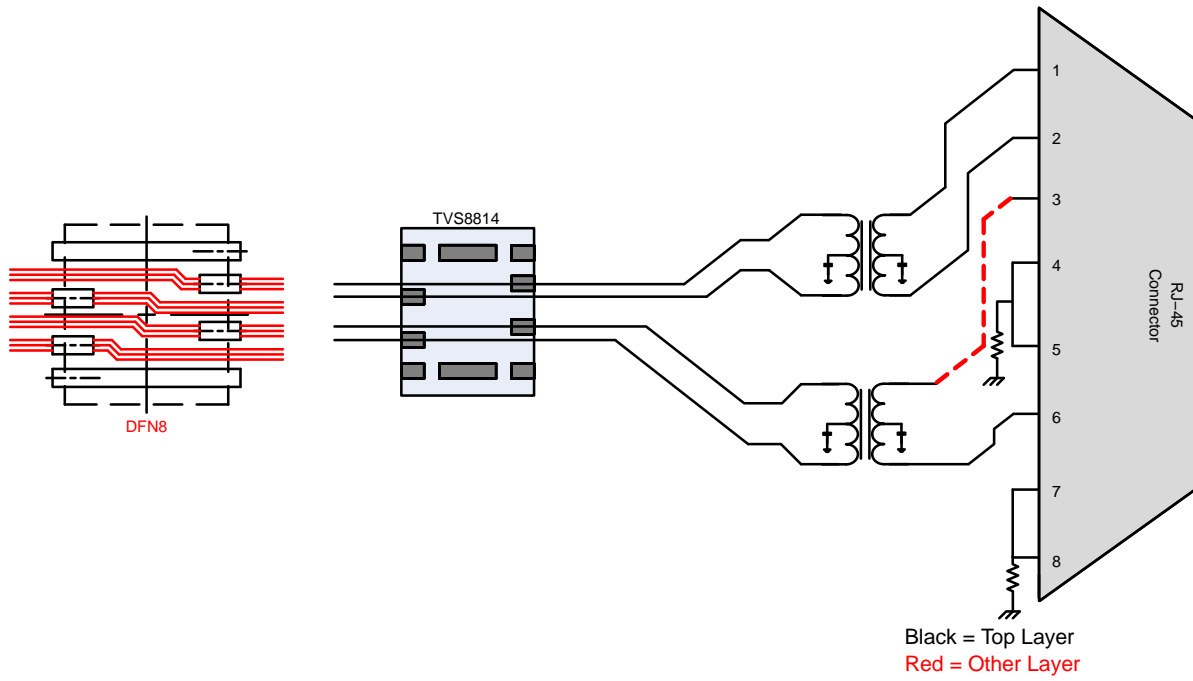

Figure 12. 10/100 Ethernet Layout Diagram and Flow-thru Routing Scheme

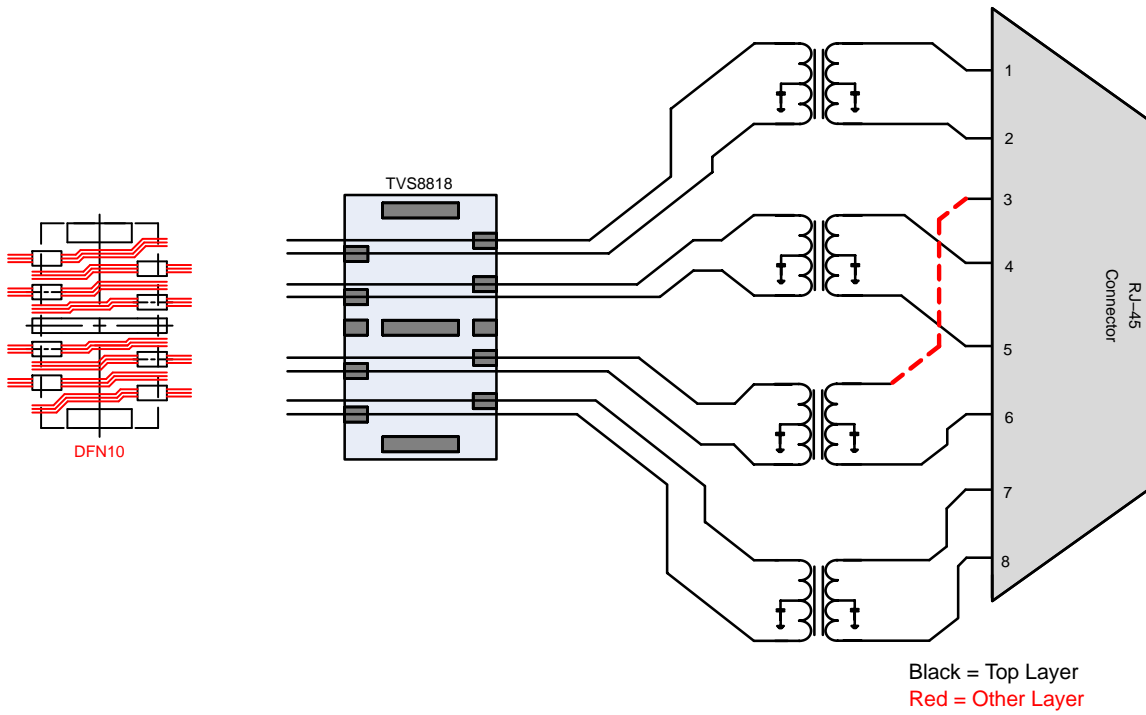
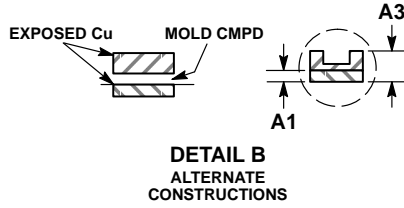
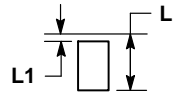
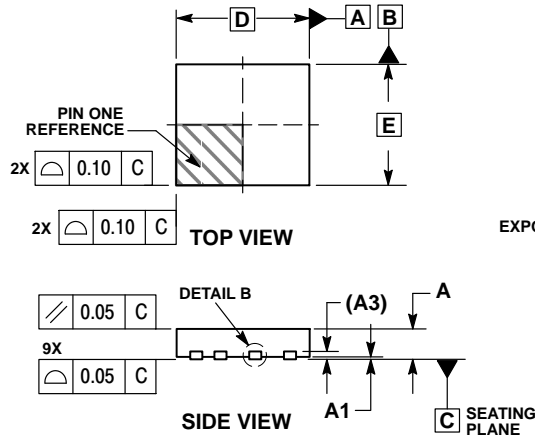

Figure 13. GbE Ethernet Layout Diagram and Flow-thru Routing Scheme

TVS8814, TVS8818

PACKAGE DIMENSIONS

UDFN8 2.2x2, 0.575P
CASE 506CV
ISSUE A



NOTES:

1. DIMENSIONING AND TOLERANCING PER ASME Y14.5M, 1994.
2. CONTROLLING DIMENSION: MILLIMETERS.
3. DIMENSIONS b APPLIES TO PLATED TERMINAL AND IS MEASURED BETWEEN 0.15 AND 0.25 MM FROM TERMINAL TIP.

DIM	MILLIMETERS	
	MIN	MAX
A	0.45	0.55
A1	0.00	0.05
A3	0.127 REF	
b	0.15	0.25
D	2.20 BSC	
E	2.00 BSC	
E3	0.20 BSC	
e	0.575 BSC	
e2	0.40 BSC	
L	0.25	0.35
L1	0.05	0.15
L2	0.95	1.05

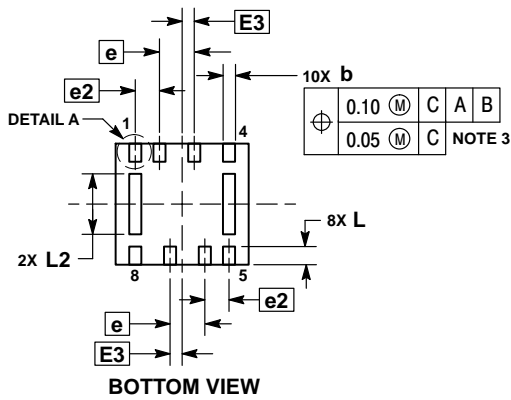

RECOMMENDED MOUNTING FOOTPRINT

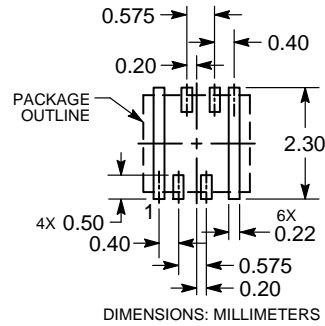

*For additional information on our Pb-Free strategy and soldering details, please download the ON Semiconductor Soldering and Mounting Techniques Reference Manual, SOLDERRM/D.

TVS8814, TVS8818

PACKAGE DIMENSIONS

UDFN10 3.5x2, 0.575P
CASE 506CU
ISSUE O

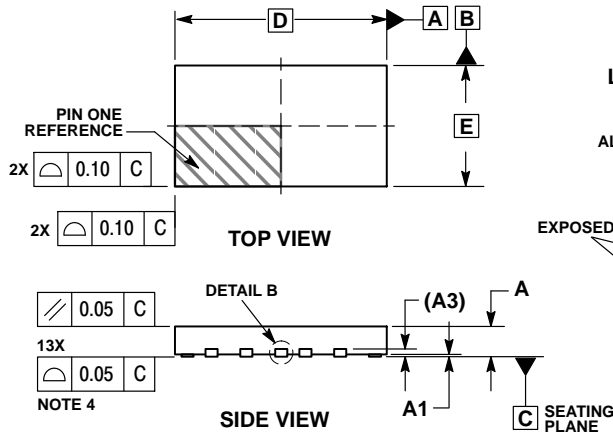

NOTES:

1. DIMENSIONING AND TOLERANCING PER ASME Y14.5M, 1994.
2. CONTROLLING DIMENSION: MILLIMETERS.
3. DIMENSIONS b APPLIES TO PLATED TERMINAL AND IS MEASURED BETWEEN 0.15 AND 0.25 MM FROM TERMINAL TIP.
4. COPLANARITY APPLIES TO THE EXPOSED PAD AS WELL AS THE TERMINALS.

DIM	MILLIMETERS	
	MIN	MAX
A	0.45	0.55
A1	0.00	0.05
A3	0.127 REF	
b	0.15	0.25
D	3.50 BSC	
E	2.00 BSC	
e	0.575 BSC	
e2	0.40 BSC	
e3	3.10 BSC	
L	0.25	0.35
L1	0.05	0.15
L2	0.95	1.05

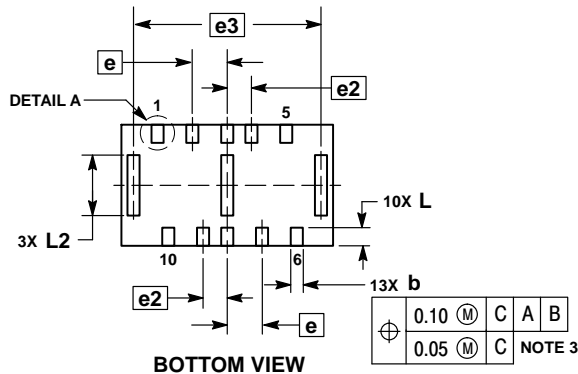

RECOMMENDED MOUNTING FOOTPRINT*

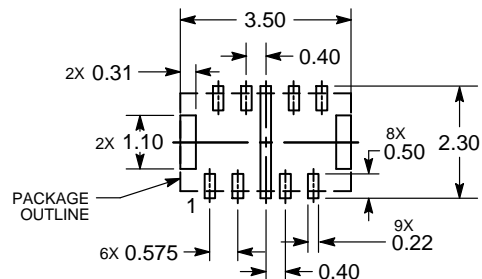

*For additional information on our Pb-Free strategy and soldering details, please download the ON Semiconductor Soldering and Mounting Techniques Reference Manual, SOLDERRM/D.

MagJack is a trademark of Bel Fuse Inc.

ON Semiconductor and the are registered trademarks of Semiconductor Components Industries, LLC (SCILLC) or its subsidiaries in the United States and/or other countries. SCILLC owns the rights to a number of patents, trademarks, copyrights, trade secrets, and other intellectual property. A listing of SCILLC's product/patent coverage may be accessed at www.onsemi.com/site/pdf/Patent-Marking.pdf. SCILLC reserves the right to make changes without further notice to any products herein. SCILLC makes no warranty, representation or guarantee regarding the suitability of its products for any particular purpose, nor does SCILLC assume any liability arising out of the application or use of any product or circuit, and specifically disclaims any and all liability, including without limitation special, consequential or incidental damages. "Typical" parameters which may be provided in SCILLC data sheets and/or specifications can and do vary in different applications and actual performance may vary over time. All operating parameters, including "Typicals" must be validated for each customer application by customer's technical experts. SCILLC does not convey any license under its patent rights nor the rights of others. SCILLC products are not designed, intended, or authorized for use as components in systems intended for surgical implant into the body, or other applications intended to support or sustain life, or for any other application in which the failure of the SCILLC product could create a situation where personal injury or death may occur. Should Buyer purchase or use SCILLC products for any such unintended or unauthorized application, Buyer shall indemnify and hold SCILLC and its officers, employees, subsidiaries, affiliates, and distributors harmless against all claims, costs, damages, and expenses, and reasonable attorney fees arising out of, directly or indirectly, any claim of personal injury or death associated with such unintended or unauthorized use, even if such claim alleges that SCILLC was negligent regarding the design or manufacture of the part. SCILLC is an Equal Opportunity/Affirmative Action Employer. This literature is subject to all applicable copyright laws and is not for resale in any manner.

PUBLICATION ORDERING INFORMATION

LITERATURE FULFILLMENT:

Literature Distribution Center for ON Semiconductor
19521 E. 32nd Pkwy, Aurora, Colorado 80011 USA
Phone: 303-675-2175 or 800-344-3860 Toll Free USA/Canada
Fax: 303-675-2176 or 800-344-3867 Toll Free USA/Canada
Email: orderlit@onsemi.com

N. American Technical Support: 800-282-9855 Toll Free
USA/Canada
Europe, Middle East and Africa Technical Support:
Phone: 421 33 790 2910
Japan Customer Focus Center
Phone: 81-3-5817-1050

ON Semiconductor Website: www.onsemi.com

Order Literature: <http://www.onsemi.com/orderlit>

For additional information, please contact your local Sales Representative