

# VMAX016001

## 50 A, 650 V Hybrid IGBT

Using the novel field stop 4<sup>th</sup> generation IGBT technology and the 1.5<sup>th</sup> generation SiC Schottky Diode technology, VMAX016001 offers the optimum performance with both low conduction and switching losses for high efficiency operations in various applications, especially totem pole bridgeless PFC and Inverter.

### Features

- AEC-Q101 Qualified
- Maximum Junction Temperature :  $T_J = 175^\circ\text{C}$
- Positive Temperature Co-efficient for Easy Parallel Operating
- High Current Capability
- Low Saturation Voltage:  $V_{CE(Sat)} = 1.6\text{ V (Typ.) @ } I_C = 50\text{ A}$
- Fast Switching
- Tighten Parameter Distribution
- No Reverse Recovery/No Forward Recovery

### Typical Applications

- Automotive
- On & Off Board Chargers
- DC-DC Converters
- PFC
- Industrial Inverter

### MAXIMUM RATINGS

Rating	Symbol	Value	Unit
Collector to Emitter Voltage	$V_{CES}$	650	V
Gate to Emitter Voltage Transient Gate to Emitter Voltage	$V_{GES}$	$\pm 20$ $\pm 30$	V
Collector Current @ $T_C = 25^\circ\text{C}$ @ $T_C = 100^\circ\text{C}$	$I_C$	100 50	A
Pulsed Collector Current (Note 1)	$I_{LM}$	200	A
Pulsed Collector Current (Note 2)	$I_{CM}$	200	A
Diode Forward Current @ $T_C = 25^\circ\text{C}$ @ $T_C = 100^\circ\text{C}$	$I_F$	40 20	A
Pulsed Diode Maximum Forward Current	$I_{FM}$	200	A
Maximum Power Dissipation @ $T_C = 25^\circ\text{C}$ @ $T_C = 100^\circ\text{C}$	PD	268 134	W
Operating Junction / Storage Temperature Range	$T_J$ , $T_{STG}$	$\pm 55$ to $+175$	$^\circ\text{C}$
Maximum Lead Temp. for Soldering Purposes, 1/8" from case for 5 seconds	$T_L$	300	$^\circ\text{C}$

Stresses exceeding those listed in the Maximum Ratings table may damage the device. If any of these limits are exceeded, device functionality should not be assumed, damage may occur and reliability may be affected.

1.  $V_{CC} = 400\text{ V}$ ,  $V_{GE} = 15\text{ V}$ ,  $I_C = 200\text{ A}$ ,  $R_G = 26\ \Omega$ , Inductive Load, 100% Tested.
2. Repetitive Rating: pulse width limited by max. Junction temperature.



**ON Semiconductor®**

[www.onsemi.com](http://www.onsemi.com)

**50 A, 650 V**  
 **$V_{CESat} = 1.6\text{ V (Typ.)}$**

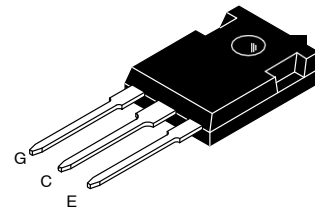
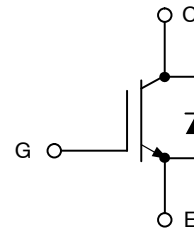

**TO-247-3L**  
**CASE 340CX**

### MARKING DIAGRAM

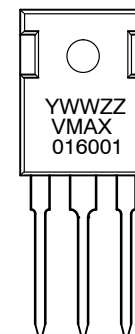

YWW = 3-Digit Data Code  
ZZ = 2-Digit Lot Traceability Code  
VMAX016001 = Specific Device Code

### ORDERING INFORMATION

Device	Package	Shipping
VMAX016001	TO-247-3L	30 Units / Rail

# VMAX016001

## THERMAL CHARACTERISTICS

Rating	Symbol	Value	Unit
Thermal resistance junction-to-case, for IGBT	$R_{\theta JC}$	0.63	°C/W
Thermal resistance junction-to-case, for Diode	$R_{\theta JC}$	1.55	°C/W
Thermal resistance junction-to-ambient	$R_{\theta JA}$	40	°C/W

## ELECTRICAL CHARACTERISTICS ( $T_J = 25^\circ\text{C}$ unless otherwise noted)

Parameter	Test Conditions	Symbol	Min.	Typ.	Max.	Unit
-----------	-----------------	--------	------	------	------	------

### OFF CHARACTERISTICS

Collector-emitter breakdown voltage, gate-emitter short-circuited	$V_{GE} = 0\text{ V}$ , $I_C = 1\text{ mA}$	$BV_{CES}$	650	-	-	V
Temperature Coefficient of Breakdown Voltage	$V_{GE} = 0\text{ V}$ , $I_C = 1\text{ mA}$	$\frac{\Delta BV_{CES}}{\Delta T_J}$	-	0.6	-	V/°C
Collector-emitter cut-off current, gate-emitter short-circuited	$V_{GE} = 0\text{ V}$ , $V_{CE} = 650\text{ V}$	$I_{CES}$	-	-	250	μA
Gate leakage current, collector-emitter short-circuited	$V_{GE} = 20\text{ V}$ , $V_{CE} = 0\text{ V}$	$I_{GES}$	-	-	±400	nA

### ON CHARACTERISTICS

Gate-emitter threshold voltage	$V_{GE} = V_{CE}$ , $I_C = 50\text{ mA}$	$V_{GE(th)}$	3.4	4.9	6.4	V
Collector-emitter saturation voltage	$V_{GE} = 15\text{ V}$ , $I_C = 50\text{ A}$ , $T_J = 175^\circ\text{C}$	$V_{CE(sat)}$	-	1.6	2.1	V
			-	1.9	-	

### DYNAMIC CHARACTERISTICS

Input capacitance	$V_{CE} = 30\text{ V}$ , $V_{GE} = 0\text{ V}$ , $f = 1\text{ MHz}$	$C_{ies}$	-	3098	-	pF
Output capacitance		$C_{oes}$	-	265	-	
Reverse transfer capacitance		$C_{res}$	-	9	-	
Gate charge total	$V_{CE} = 400\text{ V}$ , $I_C = 50\text{ V}$ , $V_{GE} = 15\text{ V}$	$Q_g$	-	94	-	nC
Gate to emitter charge		$Q_{ge}$	-	18	-	
Gate to collector charge		$Q_{gc}$	-	23	-	

### SWITCHING CHARACTERISTICS

Turn-on delay time	$T_J = 25^\circ\text{C}$ $V_{CC} = 400\text{ V}$ , $I_C = 12.5\text{ A}$ $R_G = 4.7\ \Omega$ $V_{GE} = 15\text{ V}$ Inductive Load	$t_{d(on)}$	-	17.6	-	ns
Rise time		$t_r$	-	6.4	-	
Turn-off delay time		$t_{d(off)}$	-	94.4	-	
Fall time		$t_f$	-	14.4	-	
Turn-on switching loss		$E_{on}$	-	131	-	μJ
Turn-off switching loss		$E_{off}$	-	96	-	
Total switching loss		$E_{ts}$	-	227	-	
Turn-on delay time	$T_J = 25^\circ\text{C}$ $V_{CC} = 400\text{ V}$ , $I_C = 25\text{ A}$ $R_G = 4.7\ \Omega$ $V_{GE} = 15\text{ V}$ Inductive Load	$t_{d(on)}$	-	19.2	-	ns
Rise time		$t_r$	-	11.2	-	
Turn-off delay time		$t_{d(off)}$	-	89.6	-	
Fall time		$t_f$	-	6.4	-	
Turn-on switching loss		$E_{on}$	-	311	-	μJ
Turn-off switching loss		$E_{off}$	-	141	-	
Total switching loss		$E_{ts}$	-	452	-	

# VMAX016001

## ELECTRICAL CHARACTERISTICS ( $T_J = 25^\circ\text{C}$ unless otherwise noted)

Parameter	Test Conditions	Symbol	Min.	Typ.	Max.	Unit
-----------	-----------------	--------	------	------	------	------

### SWITCHING CHARACTERISTICS

Turn-on delay time	$T_J = 175^\circ\text{C}$ $V_{CC} = 400\text{ V}$ , $I_C = 12.5\text{ A}$ $R_G = 4.7\ \Omega$ $V_{GE} = 15\text{ V}$ Inductive Load	$t_{d(on)}$	-	16	-	ns
Rise time		$t_r$	-	8	-	
Turn-off delay time		$t_{d(off)}$	-	107.2	-	
Fall time		$t_f$	-	53.6	-	
Turn-on switching loss		$E_{on}$	-	157	-	$\mu\text{J}$
Turn-off switching loss		$E_{off}$	-	193	-	
Total switching loss		$E_{ts}$	-	350	-	
Turn-on delay time	$T_J = 175^\circ\text{C}$ $V_{CC} = 400\text{ V}$ , $I_C = 25\text{ A}$ $R_G = 4.7\ \Omega$ $V_{GE} = 15\text{ V}$ Inductive Load	$t_{d(on)}$	-	17.6	-	ns
Rise time		$t_r$	-	14.4	-	
Turn-off delay time		$t_{d(off)}$	-	99.2	-	
Fall time		$t_f$	-	9.6	-	
Turn-on switching loss		$E_{on}$	-	350	-	$\mu\text{J}$
Turn-off switching loss		$E_{off}$	-	328	-	
Total switching loss		$E_{ts}$	-	678	-	

### DIODE CHARACTERISTICS

Forward voltage	$I_F = 20\text{ A}$ $I_F = 20\text{ A}, T_J = 175^\circ\text{C}$	$V_F$	-	1.45 1.83	1.75 -	V
Total Capacitance	$V_R = 400\text{ V}, f = 1\text{ MHz}$	C	-	103	-	pF
	$V_R = 600\text{ V}, f = 1\text{ MHz}$		-	99	-	

Product parametric performance is indicated in the Electrical Characteristics for the listed test conditions, unless otherwise noted. Product performance may not be indicated by the Electrical Characteristics if operated under different conditions.

TYPICAL CHARACTERISTICS

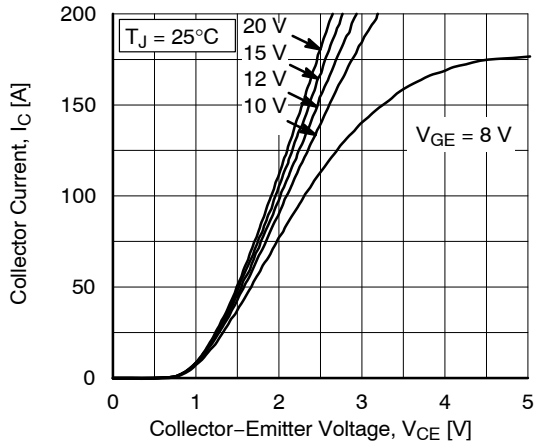

Figure 1. Typical Output Characteristics (T<sub>J</sub> = 25°C)

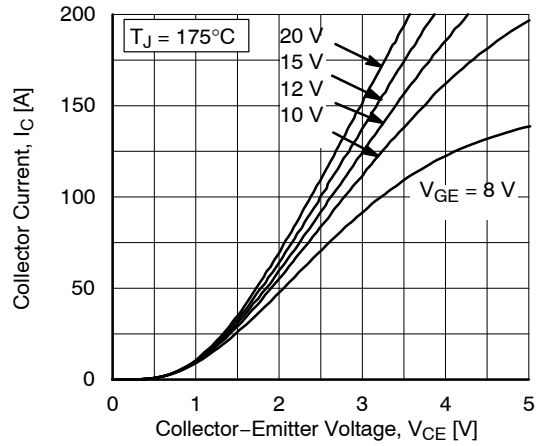

Figure 2. Typical Output Characteristics (T<sub>J</sub> = 175°C)

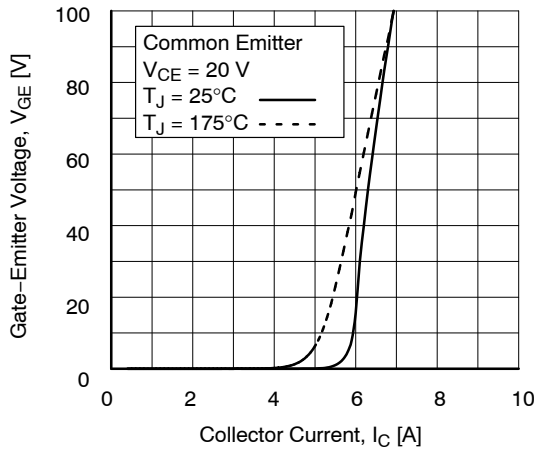

Figure 3. Transfer Characteristics

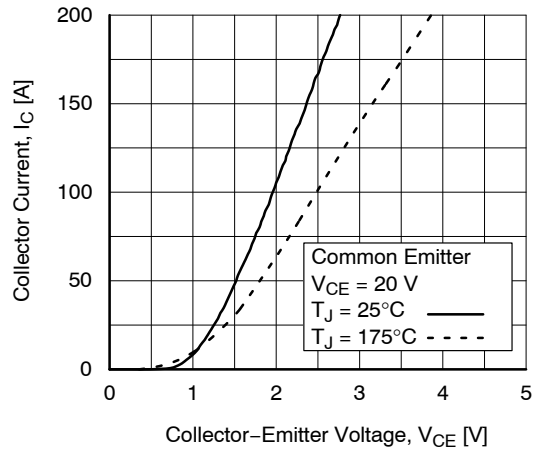

Figure 4. Typical Saturation Voltage Characteristics

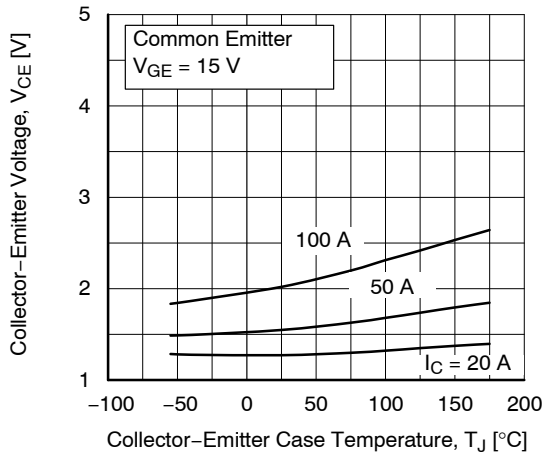

Figure 5. Saturation Voltage vs. Case Temperature at Variant Current Level

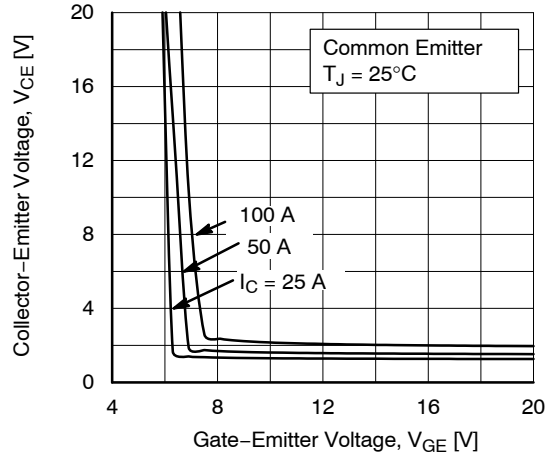

Figure 6. Saturation Voltage vs. V<sub>GE</sub> (T<sub>J</sub> = 25°C)

TYPICAL CHARACTERISTICS (continued)

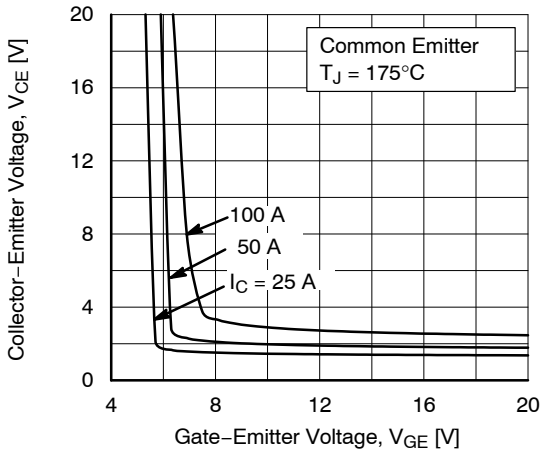

Figure 7. Saturation Voltage vs.  $V_{GE}$  ( $T_J = 175^\circ\text{C}$ )

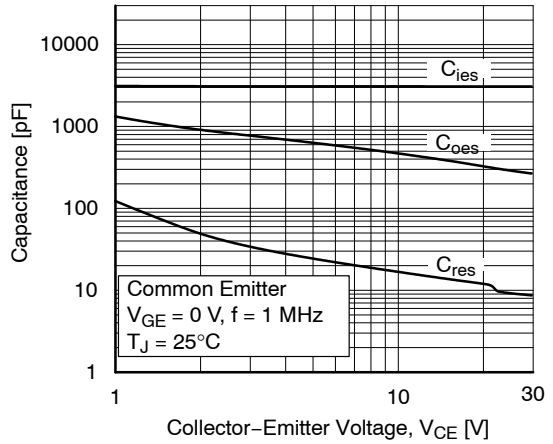

Figure 8. Capacitance Characteristics

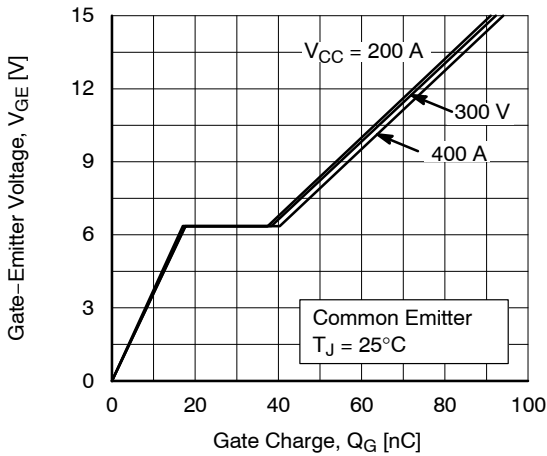

Figure 9. Gate Charge Characteristics ( $T_J = 25^\circ\text{C}$ )

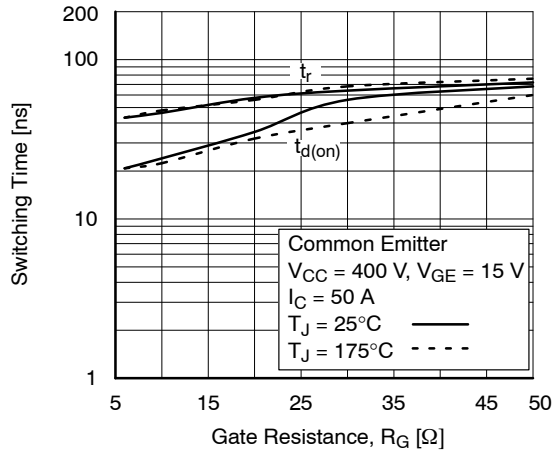

Figure 10. Turn-on Characteristics vs. Gate Resistance

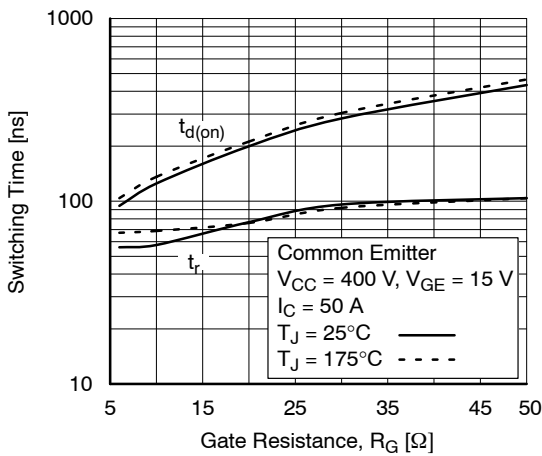

Figure 11. Turn-Off Characteristics vs. Resistance

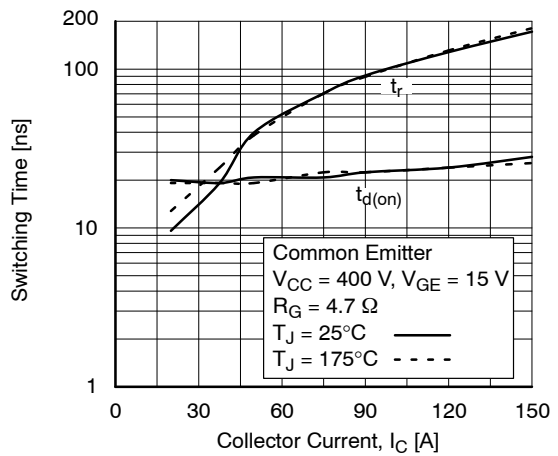

Figure 12. Turn-On Characteristics vs. Collector Current

TYPICAL CHARACTERISTICS (continued)

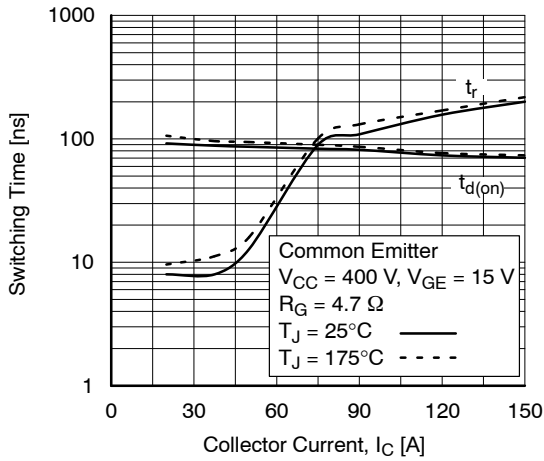

Figure 13. Turn-Off Characteristics vs. Collector Current

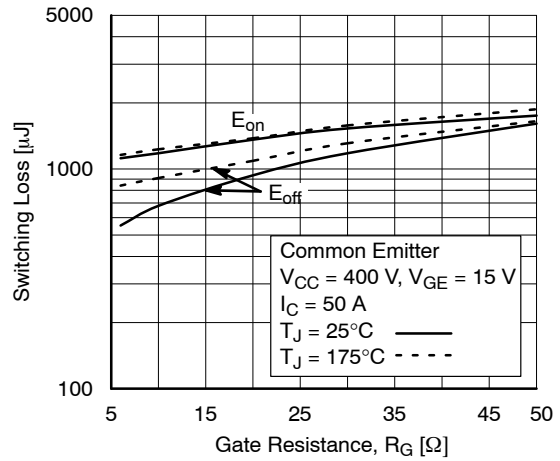

Figure 14. Switching Loss vs. Gate Resistance

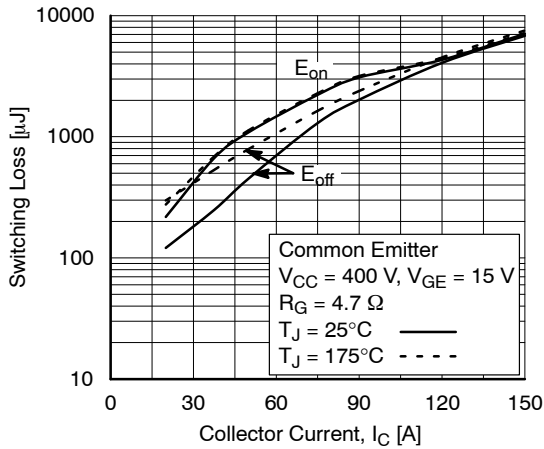

Figure 15. Switching Loss vs. Collector Current

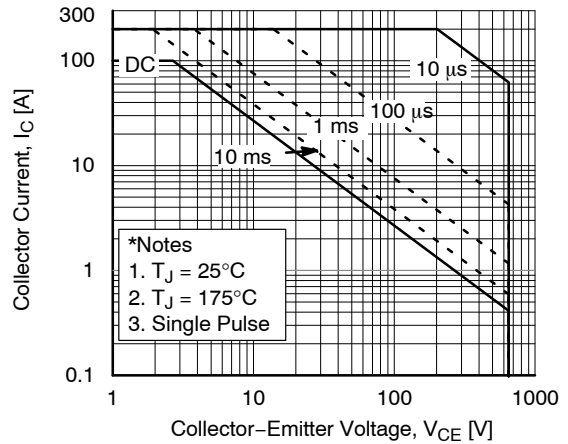

Figure 16. SOA Characteristics (FBSOA)

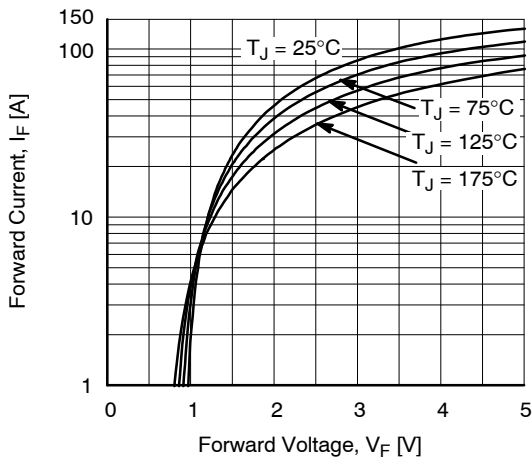

Figure 17. (Diode) Forward Characteristics vs. (Normal I-V)

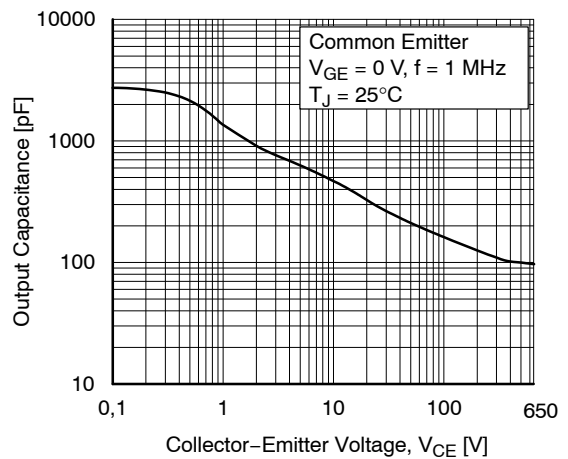

Figure 18. (Diode) Output Capacitance ( $C_{oes}$ ) vs. Reverse Voltage

# VMAX016001

## TYPICAL CHARACTERISTICS (continued)

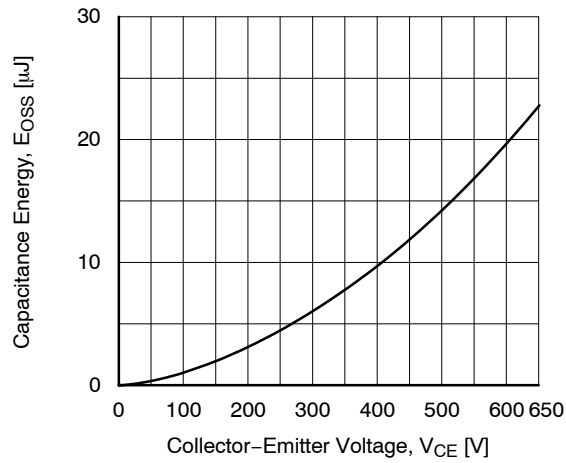

Figure 19. Output Capacitance Stored Energy

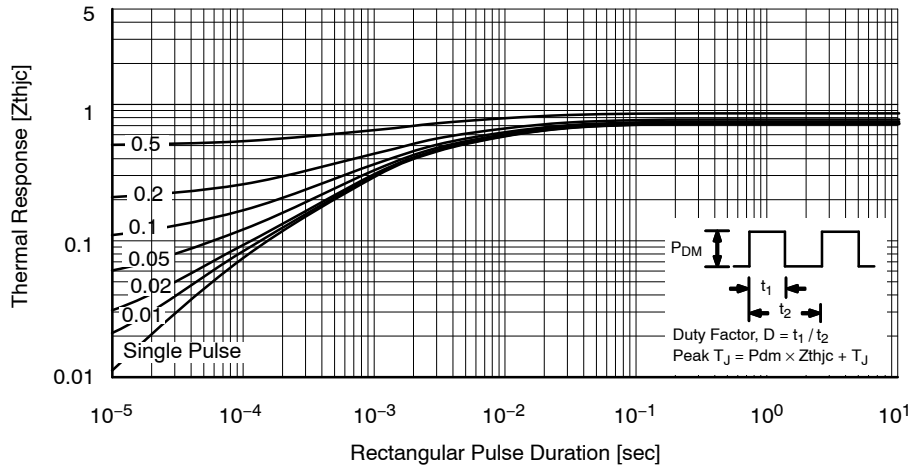

Figure 20. Transient Thermal Impedance of IGBT

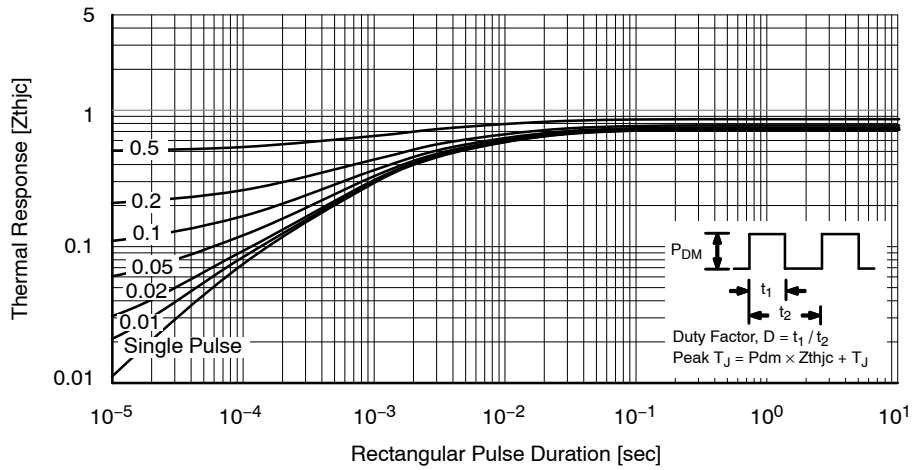
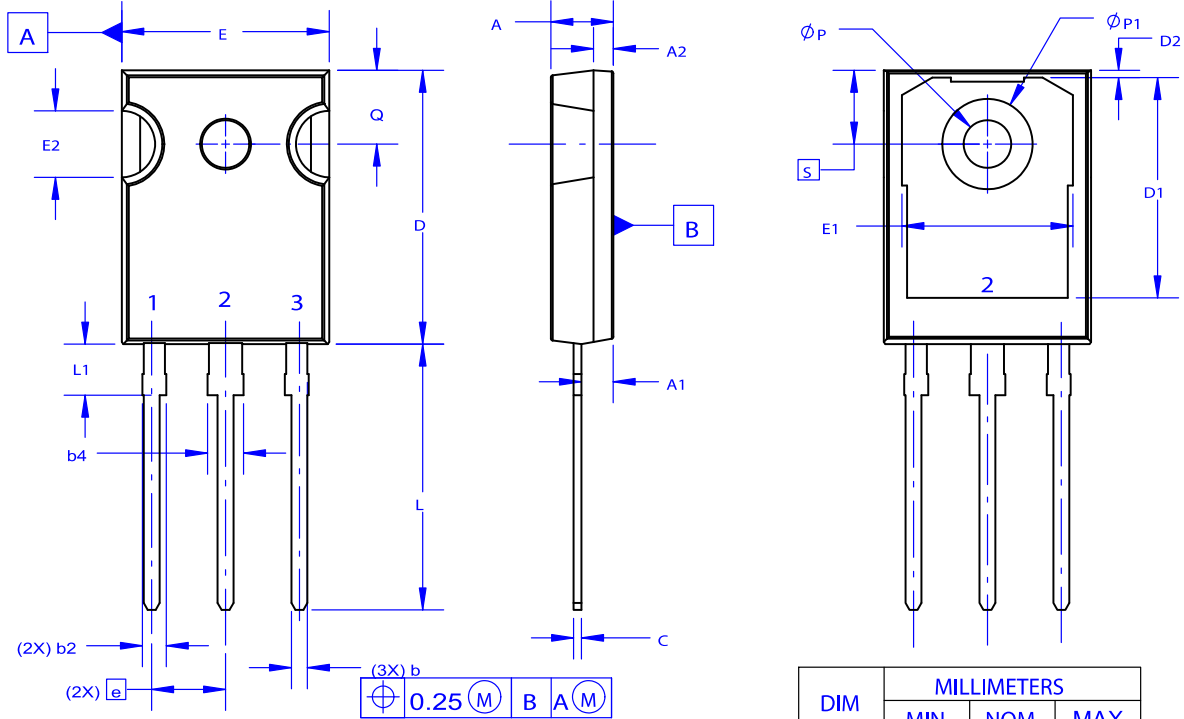

Figure 21. Transient Thermal Impedance of Diode

# VMAX016001

## PACKAGE DIMENSIONS

TO-247-3LD  
CASE 340CX  
ISSUE O



NOTES: UNLESS OTHERWISE SPECIFIED.

- A. DIMENSIONS ARE EXCLUSIVE OF BURRS, MOLD FLASH, AND TIE BAR EXTRUSIONS.
- B. ALL DIMENSIONS ARE IN MILLIMETERS.
- C. DRAWING CONFORMS TO ASME Y14.5 - 2009.
- D. DIMENSION A1 TO BE MEASURED IN THE REGION DEFINED BY L1.
- E. LEAD FINISH IS UNCONTROLLED IN THE REGION DEFINED BY L1.

### GENERIC MARKING DIAGRAM\*

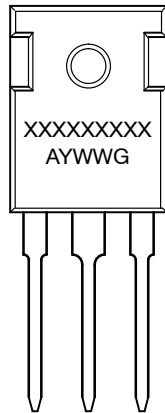

XXXXX = Specific Device Code  
 A = Assembly Location  
 Y = Year  
 WW = Work Week  
 G = Pb-Free Package

\*This information is generic. Please refer to device data sheet for actual part marking. Pb-Free indicator, "G" or microdot "▪", may or may not be present. Some products may not follow the Generic Marking.

DIM	MILLIMETERS		
	MIN	NOM	MAX
A	4.58	4.70	4.82
A1	2.20	2.40	2.60
A2	1.40	1.50	1.60
D	20.32	20.57	20.82
E	15.37	15.62	15.87
E2	4.96	5.08	5.20
e	~	5.56	~
L	19.75	20.00	20.25
L1	3.69	3.81	3.93
$\phi P$	3.51	3.58	3.65
Q	5.34	5.46	5.58
S	5.34	5.46	5.58
b	1.17	1.26	1.35
b2	1.53	1.65	1.77
b4	2.42	2.54	2.66
c	0.51	0.61	0.71
D1	13.08	~	~
D2	0.51	0.93	1.35
E1	12.81	~	~
$\phi P1$	6.60	6.80	7.00



ON Semiconductor and  are trademarks of Semiconductor Components Industries, LLC dba ON Semiconductor or its subsidiaries in the United States and/or other countries. ON Semiconductor owns the rights to a number of patents, trademarks, copyrights, trade secrets, and other intellectual property. A listing of ON Semiconductor's product/patent coverage may be accessed at [www.onsemi.com/site/pdf/Patent-Marking.pdf](http://www.onsemi.com/site/pdf/Patent-Marking.pdf). ON Semiconductor reserves the right to make changes without further notice to any products herein. ON Semiconductor makes no warranty, representation or guarantee regarding the suitability of its products for any particular purpose, nor does ON Semiconductor assume any liability arising out of the application or use of any product or circuit, and specifically disclaims any and all liability, including without limitation special, consequential or incidental damages. Buyer is responsible for its products and applications using ON Semiconductor products, including compliance with all laws, regulations and safety requirements or standards, regardless of any support or applications information provided by ON Semiconductor. "Typical" parameters which may be provided in ON Semiconductor data sheets and/or specifications can and do vary in different applications and actual performance may vary over time. All operating parameters, including "Typicals" must be validated for each customer application by customer's technical experts. ON Semiconductor does not convey any license under its patent rights nor the rights of others. ON Semiconductor products are not designed, intended, or authorized for use as a critical component in life support systems or any FDA Class 3 medical devices or medical devices with a same or similar classification in a foreign jurisdiction or any devices intended for implantation in the human body. Should Buyer purchase or use ON Semiconductor products for any such unintended or unauthorized application, Buyer shall indemnify and hold ON Semiconductor and its officers, employees, subsidiaries, affiliates, and distributors harmless against all claims, costs, damages, and expenses, and reasonable attorney fees arising out of, directly or indirectly, any claim of personal injury or death associated with such unintended or unauthorized use, even if such claim alleges that ON Semiconductor was negligent regarding the design or manufacture of the part. ON Semiconductor is an Equal Opportunity/Affirmative Action Employer. This literature is subject to all applicable copyright laws and is not for resale in any manner.

## PUBLICATION ORDERING INFORMATION

### LITERATURE FULFILLMENT:

Literature Distribution Center for ON Semiconductor  
19521 E. 32nd Pkwy, Aurora, Colorado 80011 USA  
**Phone:** 303-675-2175 or 800-344-3860 Toll Free USA/Canada  
**Fax:** 303-675-2176 or 800-344-3867 Toll Free USA/Canada  
**Email:** [orderlit@onsemi.com](mailto:orderlit@onsemi.com)

**N. American Technical Support:** 800-282-9855 Toll Free  
USA/Canada  
**Europe, Middle East and Africa Technical Support:**  
Phone: 421 33 790 2910

**ON Semiconductor Website:** [www.onsemi.com](http://www.onsemi.com)

**Order Literature:** <http://www.onsemi.com/orderlit>

For additional information, please contact your local Sales Representative