

---

## Configurable PMIC, Five Channel Buck Regulator Plus One Boost with HyperLight Load<sup>®</sup> and I<sup>2</sup>C Control

---

### Features

- Input Voltage: 2.4V to 5.5V
- Five Independent Synchronous Bucks up to 3A
- One Independent Non-Synchronous Boost 200 mA
- 200  $\mu$ A Quiescent Current (All Regulators On)
- 93% Peak Buck Efficiency, 85% Typical Efficiency at 1 mA
- Dual Power Modes: Stand-by and Normal Mode
- I<sup>2</sup>C Interface up to 3.4 MHz
- I<sup>2</sup>C On-the-Fly EEPROM Programmability, Featuring:
  - Buck and Boost Output Voltage Scaling
  - Power-on-Reset Threshold and Delay
  - Power-Up Sequencing/Sequencing Delay
  - Buck and Boost Current-Limit
  - Buck and Boost Pull-Down when Disabled
  - Individual ON, OFF, and Stand-by Modes
  - Soft-Start and Global Power-Good Masking
- 23  $\mu$ A Buck Typical Quiescent Current
- 70  $\mu$ A Boost Typical Quiescent Current
- 1.5% Output Accuracy over Temperature/Line/Load
- 2.0 MHz Boost Switching Frequency
- 1.3 MHz Buck Operation in Continuous Mode
- Ultra-Fast Buck Transient Response
- 15 mm x 15 mm x 1.25 mm Solution Size
- Thermal Shutdown and Current-Limit Protection
- 36-Pin 4.5 mm x 4.5 mm x 0.85 mm FQFN Package (0.4 mm Pitch)
- -40°C to +125°C Junction Temperature Range

### Applications

- Client and Enterprise Solid State Drives (SSD)
- Consumer and In-Vehicle Infotainment Devices
- Multimedia Devices
- Portable Handheld Devices
- Security Cameras
- Gaming Machines
- Service Provider Gateways

### General Description

The MIC7400 is a powerful, highly integrated, configurable, power management IC (PMIC) featuring five synchronous buck regulators, one boost regulator and high-speed I<sup>2</sup>C interface with an internal EEPROM.

The device offers two distinct modes of operation—“stand-by mode” and “normal mode”—intended to provide an energy-optimized solution suitable for portable handheld, and infotainment applications.

In normal mode, the programmable switching converters can be configured to support a variety of features, including start-up sequencing, timing, soft-start ramp, output voltage levels, current-limit levels and output discharge for each channel.

In stand-by mode the PMIC can be configured in a low power state by either disabling an output or by changing the output voltage to another voltage level, either lower or higher than normal-mode. In general, it's assumed that the voltage in standby mode is lower than the one in normal mode. Independent exit from stand-by mode can be achieved either by I<sup>2</sup>C communication or the external STBY pin.

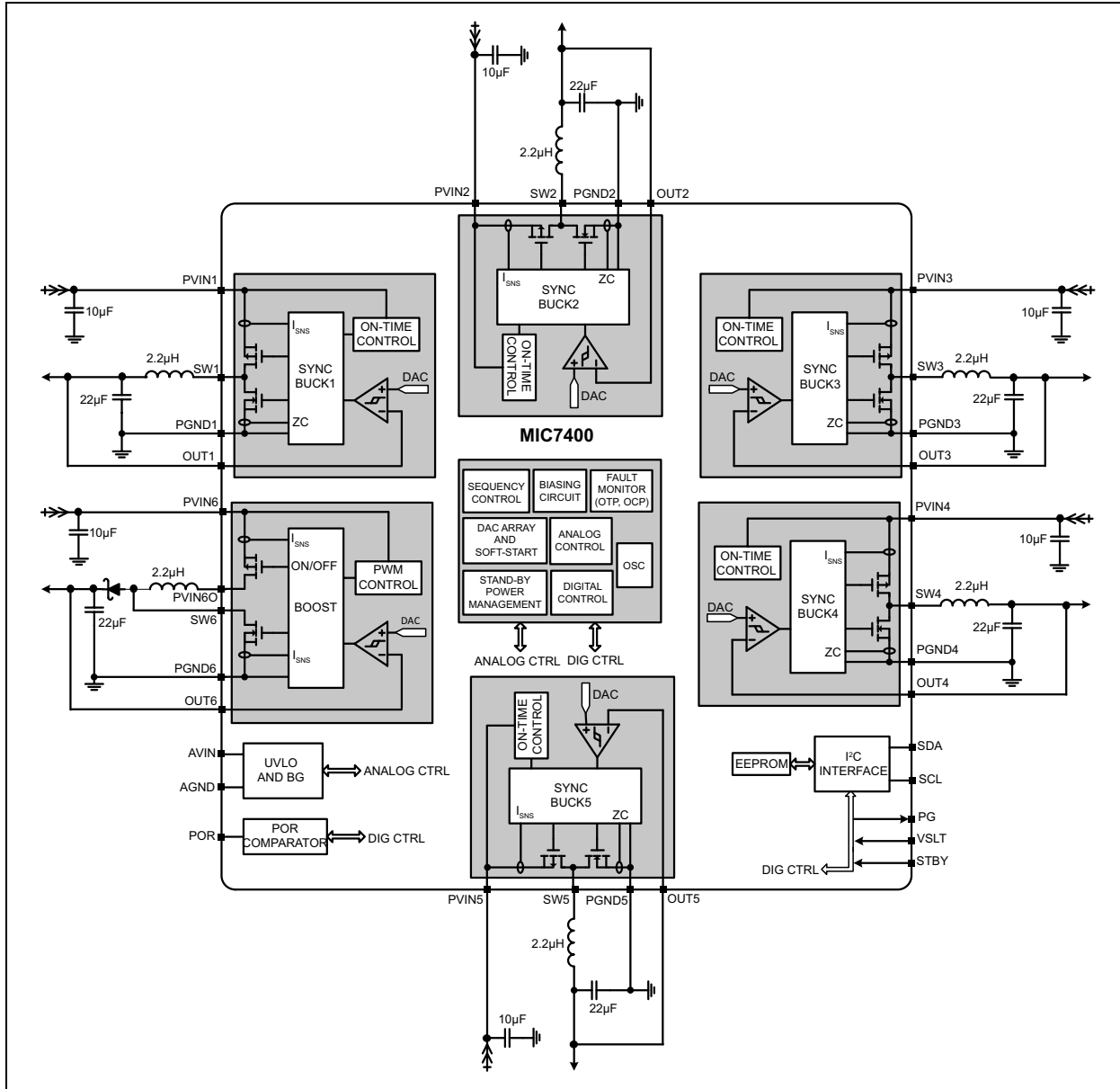
The device has five synchronous buck regulators with high-speed adaptive on-time control supporting even the challenging ultra-fast transient requirement for Core supplies. One boost regulator provides a flash memory programming supply that delivers up to 200 mA of output current. The boost is equipped with an output disconnect switch that opens if a short-to-ground fault is detected.

An internal EEPROM enables a single-chip solution across many platforms by allowing the designer to customize the PMIC for their design. Modifications can be made without the need to re-approve a new PMIC, saving valuable design resources and time.

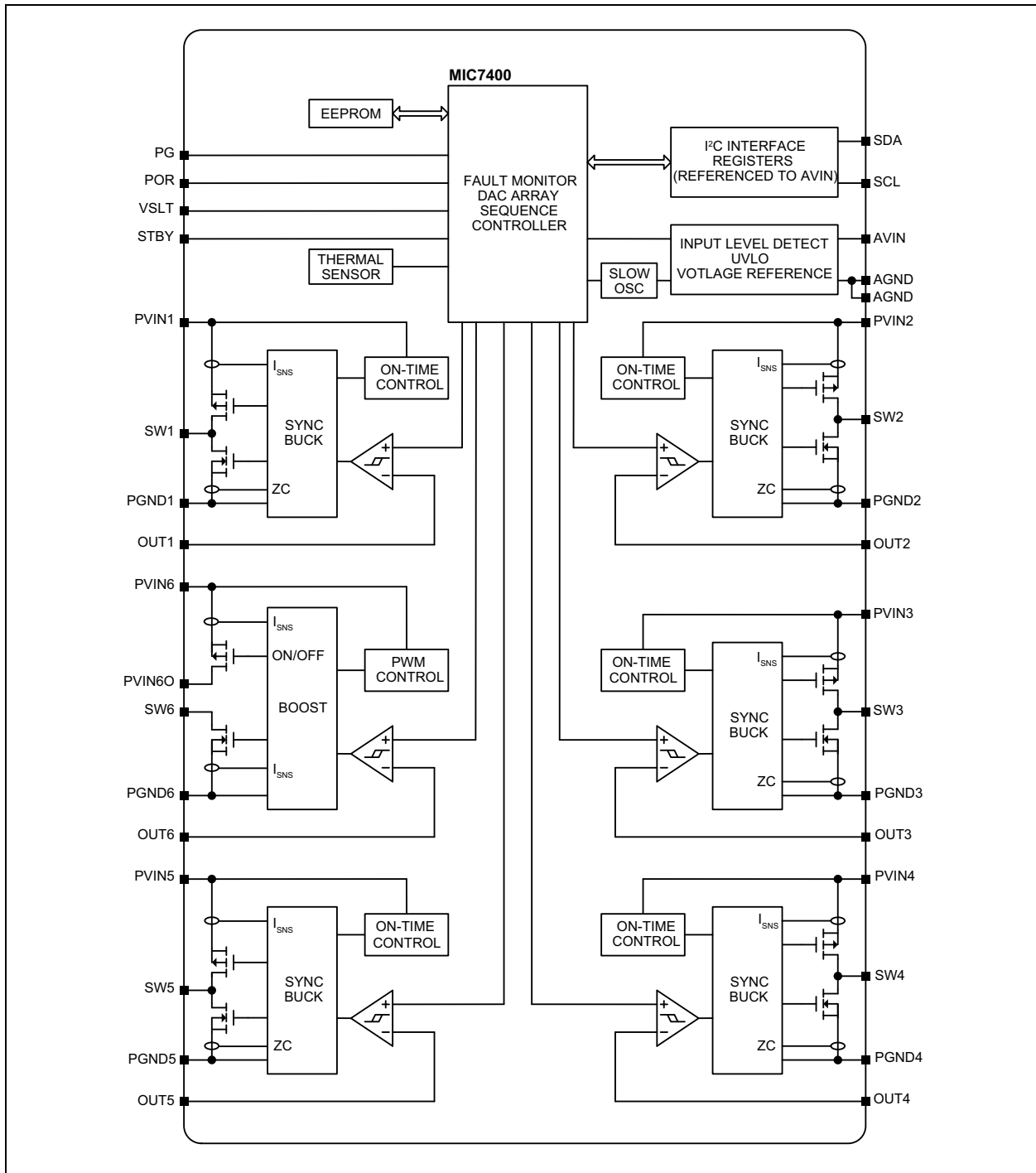
All switchers provide light load efficiency with HyperLight Load<sup>®</sup> mode for buck and PFM mode for boost. An additional benefit of this proprietary architecture is very low output ripple voltage throughout the entire load range with the use of small output capacitors. The MIC7400 is designed for use with a small inductors (down to 0.47  $\mu$ H for buck, 1.5  $\mu$ H for boost), and an output capacitor as small as 10  $\mu$ F for buck, enabling a total solution size of 15 mm x 15 mm and less than 1 mm height.

# MIC7400

## Typical Application Circuit



## Block Diagram



# MIC7400

---

## 1.0 ELECTRICAL CHARACTERISTICS

### Absolute Maximum Ratings †

|  |                     |
|--|---------------------|
| Supply Voltages ( $PV_{IN[1-6]}$ ).....            | -0.3V to +6V        |
| Analog Supply Voltage ( $AV_{IN}$ ).....           | -0.3V to +6V        |
| Buck Output Voltages ( $V_{OUT[1-5]}$ ).....       | -0.3V to +6V        |
| Boost Output Voltage ( $V_{OUT6}$ ).....           | -0.3V to +20V       |
| Buck Switch Voltages ( $V_{SW[1-5]}$ ).....        | -0.3V to +6V        |
| Boost Switch Voltage ( $V_{SW6}$ ).....            | -0.3V to +20V       |
| Power Good Voltage ( $V_{PG}$ ).....               | -0.3V to $AV_{IN}$  |
| Power-On Reset Output ( $V_{POR}$ ).....           | -0.3V to +6V        |
| POR Threshold Voltage ( $V_{VSLT}$ ).....          | -0.3V to +6V        |
| Standby Voltage ( $V_{STBY}$ ).....                | -0.3V to +6V        |
| I <sup>2</sup> C IO ( $V_{SDA}$ , $V_{SCL}$ )..... | -0.3V to $AV_{IN}$  |
| AGND to PGND[1-6].....                             | -0.3V to +0.3V      |
| ESD Rating (Note 1).....                           | HBM: 2 kV; MM: 200V |

### Operating Ratings ‡

|  |                 |
|--|-----------------|
| Input Voltage ( $PV_{IN[1-6]}$ ).....              | +2.4V to +5.5V  |
| Analog Input Voltage ( $AV_{IN}$ ).....            | +2.4V to +5.5V  |
| Buck Output Voltage Range ( $V_{OUT[1-5]}$ ).....  | +0.8V to +3.3V  |
| Boost Output Voltage Range ( $V_{OUT6}$ ).....     | +7V to +14V     |
| Power Good Voltage ( $V_{PG}$ ).....               | 0V to $AV_{IN}$ |
| Power-On Reset Output ( $V_{POR}$ ).....           | 0V to $AV_{IN}$ |
| POR Threshold Voltage ( $V_{VSLT}$ ).....          | 0V to $AV_{IN}$ |
| Standby Voltage ( $V_{STBY}$ ).....                | 0V to $AV_{IN}$ |
| I <sup>2</sup> C IO ( $V_{SDA}$ , $V_{SCL}$ )..... | 0V to $AV_{IN}$ |

† **Notice:** Stresses above those listed under “Absolute Maximum Ratings” may cause permanent damage to the device. This is a stress rating only and functional operation of the device at those or any other conditions above those indicated in the operational sections of this specification is not intended. Exposure to maximum rating conditions for extended periods may affect device reliability. Specifications are for packaged product only.

‡ **Notice:** The device is not guaranteed to function outside its operating ratings.

**Note 1:** Devices are ESD sensitive. Handling precautions are recommended. Human body model, 1.5 kΩ in series with 100 pF.

**TABLE 1-1: ELECTRICAL CHARACTERISTICS**

**Electrical Characteristics:**  $V_{IN} = AV_{IN} = PV_{IN(1-6)} = 5.0V$ ;  $V_{OUT1} = 1.8V$ ;  $V_{OUT2} = 1.1V$ ;  $V_{OUT3} = 1.8V$ ;  $V_{OUT4} = 1.05V$ ;  $V_{OUT5} = 1.25V$ ;  $V_{OUT6} = 12V$ .  $T_A = +25^{\circ}C$ , unless otherwise noted. **Bold** values indicate  $-40^{\circ}C \leq T_J \leq +125^{\circ}C$ .  
**Note 1**

| Parameter   | Min.        | Typ. | Max.        | Units       | Conditions                             |
|---|-------------|------|-------------|-------------|--|
| <b>Input Supply (<math>V_{IN}</math>)</b>                                       |             |      |             |             |  |
| Input Voltage Range ( $AV_{IN}$ , $PV_{IN(1-6)}$ )                              | <b>2.4</b>  | —    | <b>5.5</b>  | V           | —                                      |
| Operating Quiescent Current into $AV_{IN}$<br>( <b>Note 2</b> , <b>Note 3</b> ) | —           | 200  | 240         | $\mu A$     | $V_{IN} = 5.0V$ ; $I_{OUT} = 0A$       |
| Operating Quiescent Current into $PV_{IN}$<br>( <b>Note 2</b> )                 | —           | 0.3  | 1.0         | $\mu A$     | $V_{IN} = 5.0V$ ; $I_{OUT} = 0A$       |
| Undervoltage Lockout Threshold  | <b>2.15</b> | 2.25 | <b>2.35</b> | V           | $AV_{IN}$ Rising                       |
| Undervoltage Lockout Hysteresis   | —           | 150  | —           | mV          | —                                      |
| <b>Standby Input (STBY)</b>   |             |      |             |             |  |
| Logic Level High  | 1.2         | —    | —           | V           | —                                      |
| Logic Level Low   | —           | —    | <b>0.4</b>  | V           | —                                      |
| Bias Current into Pin   | —           | —    | 200         | nA          | $V_{STBY} = V_{IN}$                    |
| Bias Current out of Pin   | —           | —    | 200         | nA          | $V_{STBY} = 0V$                        |
| Rising/Falling Edge Reset Deglitch  | —           | 100  | —           | $\mu s$     | —                                      |
| <b>POR Threshold Input (<math>V_{SLT}</math>)</b>                               |             |      |             |             |  |
| Logic Level High  | <b>1.2</b>  | —    | —           |             | —                                      |
| Logic Level Low   | —           | —    | <b>0.4</b>  |             | —                                      |
| Bias Current Into Pin   | —           | —    | 200         |             | $V_{VSLT} = V_{IN}$                    |
| Bias Current Out of Pin   | —           | —    | 200         |             | $V_{VSLT} = 0V$                        |
| <b>Power-On-Reset (POR) Comparator</b>  |             |      |             |             |  |
| POR Upper Comparator Range  | 2.646       | 2.7  | 2.754       | V           | $AV_{IN}$ Rising, $V_{VSLT} = 0V$      |
| POR Lower Comparator Range  | 2.548       | 2.6  | 2.652       | V           | $AV_{IN}$ Falling, $V_{VSLT} = 0V$     |
| POR Upper Comparator Range  | 3.626       | 3.7  | 3.774       | V           | $AV_{IN}$ Rising, $V_{VSLT} = V_{IN}$  |
| POR Lower Comparator Range  | 3.528       | 3.6  | 3.672       | V           | $AV_{IN}$ Falling, $V_{VSLT} = V_{IN}$ |
| <b>Power Reset Output (POR) and Timer</b>                                       |             |      |             |             |  |
| POR Delay   | 18          | 20   | 22          | ms          | —                                      |
| POR Deglitch Delay  | —           | 50   | —           | $\mu s$     | $AV_{IN}$ Falling                      |
| POR Output Low Voltage  | —           | 75   | 400         | mV          | $I_{POR} = 10\text{ mA}$ (sinking)     |
| POR Leakage Current   | —           | —    | 200         | nA          | $V_{POR} = 5.5V$                       |
| <b>Global Power Good Output (PG)</b>  |             |      |             |             |  |
| Buck Power Good Threshold Voltage   | 87          | 91   | 95          | $\%V_{OUT}$ | $V_{OUT[1-5]}$ Rising                  |
| Buck Hysteresis ( <b>Note 4</b> )   | —           | 4    | —           | $\%V_{OUT}$ | $V_{OUT[1-5]}$ Falling                 |
| Boost Power Good Threshold Voltage  | 87          | 91   | 95          | $\%V_{OUT}$ | $V_{OUT[6]}$ Rising                    |
| Boost Hysteresis ( <b>Note 4</b> )  | —           | 380  | —           | mV          | $V_{OUT[6]}$ Falling                   |
| Power Good Output Low Voltage   | —           | 75   | 400         | mV          | $I_{PG} = 10\text{ mA}$ (sinking)      |
| Power Good Leakage Current  | —           | 0.01 | 200         | nA          | $V_{PG} = 5.5V$                        |
| Power Good Deglitch Delay   | —           | 100  | —           | $\mu s$     | $V_{OUT[1-6]}$ Falling                 |
| Output Sequencing Delay ( <b>Note 4</b> )                                       | 0.96        | 1    | 1.04        | ms          | —                                      |
| <b>Thermal Protection</b>   |             |      |             |             |  |
| Thermal Shutdown  | —           | 160  | —           | $^{\circ}C$ | $T_J$ Rising                           |
| Thermal Hysteresis  | —           | 20   | —           | $^{\circ}C$ | —                                      |

# MIC7400

**TABLE 1-1: ELECTRICAL CHARACTERISTICS (CONTINUED)**

**Electrical Characteristics:**  $V_{IN} = AV_{IN} = PV_{IN(1-6)} = 5.0V$ ;  $V_{OUT1} = 1.8V$ ;  $V_{OUT2} = 1.1V$ ;  $V_{OUT3} = 1.8V$ ;  $V_{OUT4} = 1.05V$ ;  $V_{OUT5} = 1.25V$ ;  $V_{OUT6} = 12V$ .  $T_A = +25^{\circ}C$ , unless otherwise noted. **Bold** values indicate  $-40^{\circ}C \leq T_J \leq +125^{\circ}C$ .  
**Note 1**

| Parameter  | Min.        | Typ. | Max.       | Units              | Conditions   |
|--|-------------|------|------------|--------------------|--|
| <b>Synchronous Buck (<math>V_{OUT1} - V_{OUT5}</math>)</b> |             |      |            |                    |  |
| <b>Buck Output Voltage Accuracy (OUT[1-5])</b>             |             |      |            |                    |  |
| Typical Output Voltage 1 Accuracy (Note 5)                 | <b>-1.5</b> | —    | <b>1.5</b> | %                  | Includes Load, Line, and Reference                   |
| Typical Output Voltage 2 Accuracy (Note 5)                 | <b>-1.5</b> | —    | <b>1.5</b> | %                  | Includes Load, Line, and Reference                   |
| Typical Output Voltage 3 Accuracy (Note 5)                 | <b>-1.5</b> | —    | <b>1.5</b> | %                  | Includes Load, Line, and Reference                   |
| Typical Output Voltage 4 Accuracy (Note 5)                 | <b>-1.5</b> | —    | <b>1.5</b> | %                  | Includes Load, Line, and Reference                   |
| Typical Output Voltage 5 Accuracy (Note 5)                 | <b>-1.5</b> | —    | <b>1.5</b> | %                  | Includes Load, Line, and Reference                   |
| Output Voltage 1 Accuracy (Note 5)                         | <b>-1</b>   | —    | <b>1</b>   | %                  | —  |
| Output Voltage 2 Accuracy (Note 5)                         | <b>-1</b>   | —    | <b>1</b>   | %                  | —  |
| Output Voltage 3 Accuracy (Note 5)                         | <b>-1</b>   | —    | <b>1</b>   | %                  | —  |
| Output Voltage 4 Accuracy (Note 5)                         | <b>-1</b>   | —    | <b>1</b>   | %                  | —  |
| Output Voltage 5 Accuracy (Note 5)                         | <b>-1</b>   | —    | <b>1</b>   | %                  | —  |
| Load Regulation  | —           | 0.1  | —          | %                  | $I_{OUT} = 10 \text{ mA to } I_{OUT(MAX)}$           |
| Line Regulation  | —           | 0.05 | —          | %                  | $V_{IN} = 3.3V \text{ to } 5.0V$                     |
| <b>Buck Soft-Start</b>                                     |             |      |            |                    |  |
| Soft-Start (1-5) LSB (Note 4, Note 6)                      | 3.84        | 4.0  | 4.16       | $\mu\text{s/step}$ | —  |
| <b>Buck Internal MOSFETS</b>                               |             |      |            |                    |  |
| High-Side On-Resistance                                    | —           | 54   | —          | m $\Omega$         | $V_{IN} = 3.3V$ ; $I_{SW[1-5]} = 200 \text{ mA}$     |
| High-Side On-Resistance                                    | —           | 40   | —          | m $\Omega$         | $V_{IN} = 5.0V$ ; $I_{SW[1-5]} = 200 \text{ mA}$     |
| Low-Side On-Resistance                                     | —           | 37   | —          | m $\Omega$         | $V_{IN} = 3.3V$ ; $I_{SW[1-5]} = -200 \text{ mA}$    |
| Low-Side On-Resistance                                     | —           | 30   | —          | m $\Omega$         | $V_{IN} = 5.0V$ ; $I_{SW[1-5]} = -200 \text{ mA}$    |
| Output Pull-Down Resistance                                | 75          | 90   | 200        | $\Omega$           | $V_{SW[1-5]} = 0V$                                   |
| <b>Buck Controller Timing</b>                              |             |      |            |                    |  |
| Fixed On-Time (Note 7)                                     | —           | 220  | —          | ns                 | $V_{IN} = 3.3$ ; $V_{OUT} = 1.0V$ ; $I_{OUT} = 1.0A$ |
| Minimum OFF-Time   | —           | 80   | —          | ns                 | —  |
| <b>Buck Current-Limit (OUT1 - OUT5)</b>                    |             |      |            |                    |  |
| Buck 1 Current-Limit Threshold                             | 3.075       | 4.1  | 5.125      | A                  | See Table 4-3 for IPROG Settings                     |
| Buck 2 Current-Limit Threshold                             | 3.075       | 4.1  | 5.125      | A                  | See Table 4-3 for IPROG Settings                     |
| Buck 3 Current-Limit Threshold                             | 3.075       | 4.1  | 5.125      | A                  | See Table 4-3 for IPROG Settings                     |
| Buck 4 Current-Limit Threshold                             | 4.88        | 6.1  | 7.32       | A                  | See Table 4-3 for IPROG Settings                     |
| Buck 5 Current-Limit Threshold                             | 3.075       | 4.1  | 5.125      | A                  | See Table 4-3 for IPROG Settings                     |
| Gross High-Side Current-Limit [1-5]                        | —           | 150  | —          | %                  | With Respect to Buck [x] Current-Limit               |
| Zero Cross Threshold                                       | —           | 0    | —          | mV                 | Zero crossing detector                               |

**TABLE 1-1: ELECTRICAL CHARACTERISTICS (CONTINUED)**

**Electrical Characteristics:**  $V_{IN} = AV_{IN} = PV_{IN(1-6)} = 5.0V$ ;  $V_{OUT1} = 1.8V$ ;  $V_{OUT2} = 1.1V$ ;  $V_{OUT3} = 1.8V$ ;  $V_{OUT4} = 1.05V$ ;  $V_{OUT5} = 1.25V$ ;  $V_{OUT6} = 12V$ .  $T_A = +25^\circ C$ , unless otherwise noted. **Bold** values indicate  $-40^\circ C \leq T_J \leq +125^\circ C$ .

Note 1

| Parameter   | Min.        | Typ. | Max.       | Units        | Conditions  |
|---|-------------|------|------------|--------------|---|
| <b>Boost (<math>V_{OUT6}</math>)</b>                |             |      |            |              |   |
| <b>Boost Output Voltage (<math>V_{OUT6}</math>)</b> |             |      |            |              |   |
| Typical Output Voltage Accuracy (Note 5)            | <b>-1.5</b> | —    | <b>1.5</b> | %            | Includes Load, Line, and Reference                            |
| Output Voltage Accuracy (Note 5)                    | <b>-1</b>   | —    | <b>1</b>   | %            | —   |
| Load Regulation                                     | —           | 0.2  | —          | %            | $I_{OUT6} = 1.0 \text{ mA to } 200 \text{ mA}$                |
| Line Regulation                                     | —           | 0.2  | —          | %            | $V_{IN} = 2.4V \text{ to } 5.5V$ ; $I_{OUT6} = 10 \text{ mA}$ |
| $V_{OUT6}$ Discharge Current                        | 111         | 148  | 185        | mA           | $V_{IN} = 3.3V$ ; $V_{OUT6} = 12V$                            |
| <b>Boost Soft-Start Step Duration</b>               |             |      |            |              |   |
| Soft-Start 6 LSB (Note 4, Note 6)                   | 3.84        | 4.0  | 4.16       | $\mu s/step$ | —   |
| <b>Boost Internal MOSFETs</b>                       |             |      |            |              |   |
| Low-Side On-Resistance                              | —           | 160  | —          | m $\Omega$   | $V_{IN} = 3.3V$ ; $I_{SW1} = -100 \text{ mA}$                 |
| Low-Side On-Resistance                              | —           | 140  | —          | m $\Omega$   | $V_{IN} = 5.0V$ ; $I_{SW1} = -100 \text{ mA}$                 |
| <b>Boost Disconnect MOSFETs</b>                     |             |      |            |              |   |
| Disconnect Switch On-Resistance                     | —           | 90   | —          | m $\Omega$   | $I_{PVIN6O} = 100 \text{ mA}$ ; $V_{IN} = 3.3V$               |
| Disconnect Switch Current-Limit                     | —           | 5    | —          | A            | —   |
| <b>Boost Switching Frequency</b>                    |             |      |            |              |   |
| Switching Frequency (PWM Mode)                      | 1.92        | 2.0  | 2.08       | MHz          | —   |
| Minimum Duty Cycle                                  | 35          | 40   | 45         | %            | —   |
| Maximum Duty Cycle                                  | 80          | 85   | 90         | %            | —   |
| <b>Boost Current-Limit</b>                          |             |      |            |              |   |
| NMOS Current-Limit Threshold                        | —           | 2.24 | —          | A            | —   |
| <b>I<sup>2</sup>C Interface</b>                     |             |      |            |              |   |
| <b>I<sup>2</sup>C Interface (SCL, SDA)</b>          |             |      |            |              |   |
| Low Level Input Voltage                             | —           | —    | <b>0.4</b> | V            | —   |
| High Level Input Voltage                            | <b>1.2</b>  | —    | —          | V            | —   |
| Low Level Input Current                             | -200        | 0.01 | 200        | nA           | —   |
| High Level Input Current                            | -200        | 0.01 | 200        | nA           | —   |
| SDA Pull-Down Resistance                            | —           | 20   | —          | $\Omega$     | —   |
| SDA Logic 0 Output Voltage                          | —           | —    | <b>0.4</b> | V            | $I_{SDA} = 3 \text{ mA}$                                      |
| CLK, DATA Pin Capacitance                           | —           | 0.7  | —          | pF           | —   |
| <b>I<sup>2</sup>C Interface Timing (Note 4)</b>     |             |      |            |              |   |
| SCL Clock Frequency                                 | —           | —    | <b>100</b> | kHz          | Standard Mode   |
|   | —           | —    | <b>400</b> | kHz          | Fast Mode   |
|   | —           | —    | <b>3.4</b> | MHz          | High Speed Mode (Note 4)                                      |

**Note 1:** Specifications are for packaged product only.

**2:** Tested in a non-switching configuration.

**3:** When all outputs are configured to the minimum programmable voltage.

**4:** Guaranteed by design.

**5:** Not tested in a closed loop configuration.

**6:** The soft-start time is calculated using the following equation:  $t_{softstart} = [(V_{OUT\_PROGRAM} - 0.15)/0.05 + 1] \times t_{RAMP}$ .

**7:** Buck frequency is calculated using the following equation  $f_{SW} = (V_{OUT}/V_{IN}) \times (1/t_{ON})$ .

# MIC7400

---

---

## TEMPERATURE SPECIFICATIONS (Note 1)

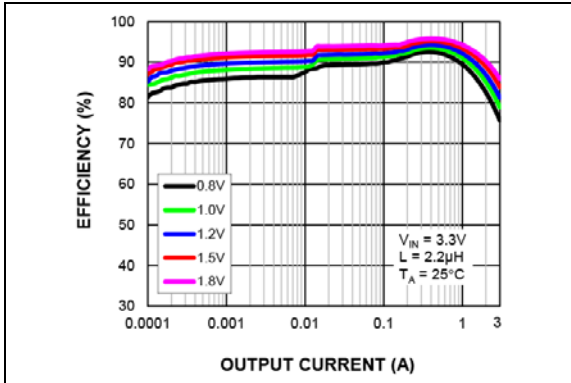
| Parameters                           | Sym.          | Min. | Typ. | Max. | Units | Conditions |
|--------------------------------------|---------------|------|------|------|-------|------------|
| <b>Temperature Ranges</b>            |               |      |      |      |       |            |
| Junction Operating Temperature Range | $T_J$         | -40  | —    | +125 | °C    | —          |
| Ambient Storage Temperature Range    | $T_S$         | -40  | —    | +150 | °C    | —          |
| <b>Package Thermal Resistance</b>    |               |      |      |      |       |            |
| Thermal Resistance FQFN-36Ld         | $\theta_{JA}$ | —    | 30   | —    | °C/W  | —          |

**Note 1:** The maximum allowable power dissipation is a function of ambient temperature, the maximum allowable junction temperature and the thermal resistance from junction to air (i.e.,  $T_A$ ,  $T_J$ ,  $\theta_{JA}$ ). Exceeding the maximum allowable power dissipation will cause the device operating junction temperature to exceed the maximum +125°C rating. Sustained junction temperatures above +125°C can impact the device reliability.

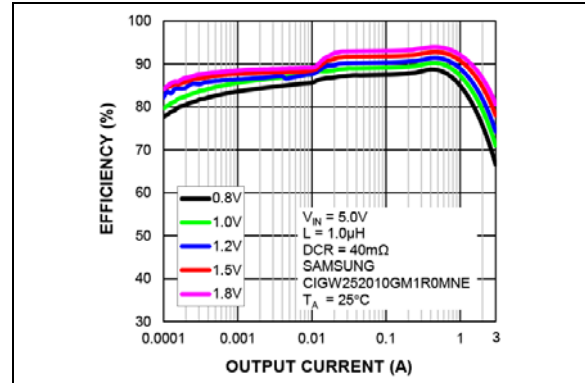


## 2.0 TYPICAL PERFORMANCE CURVES

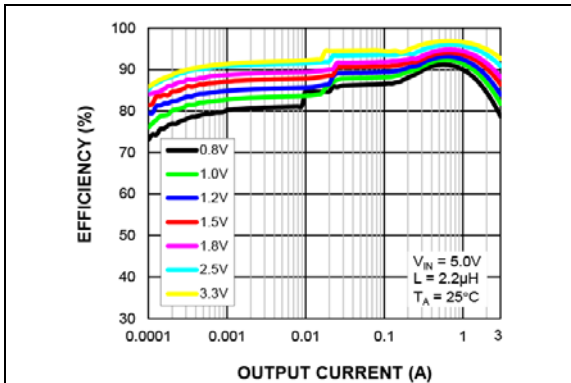
**Note:** The graphs and tables provided following this note are a statistical summary based on a limited number of samples and are provided for informational purposes only. The performance characteristics listed herein are not tested or guaranteed. In some graphs or tables, the data presented may be outside the specified operating range (e.g., outside specified power supply range) and therefore outside the warranted range.



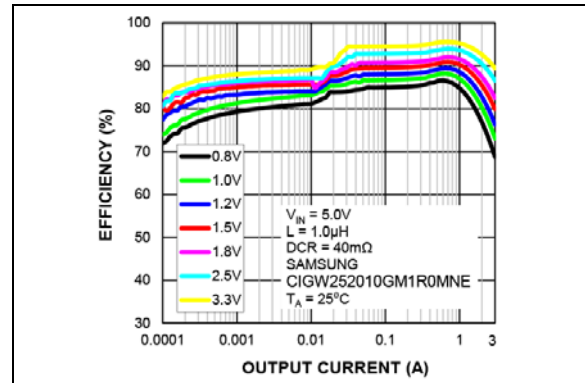
**FIGURE 2-1:** Buck Efficiency (LDCR = 0 mΩ) vs. Output Current.



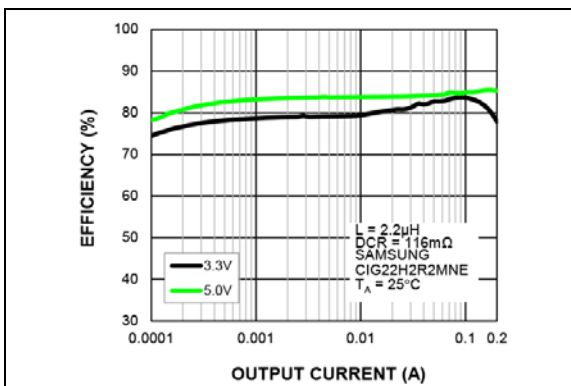
**FIGURE 2-4:** Buck Efficiency (LDCR = 40 mΩ) vs. Output Current.



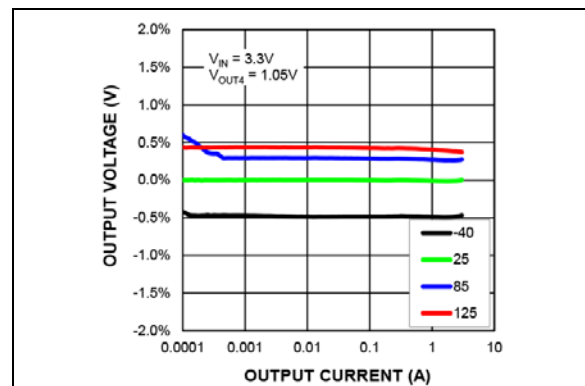
**FIGURE 2-2:** Buck Efficiency (LDCR = 0 mΩ) vs. Output Current.



**FIGURE 2-5:** Buck Efficiency (LDCR = 40 mΩ) vs. Output Current.

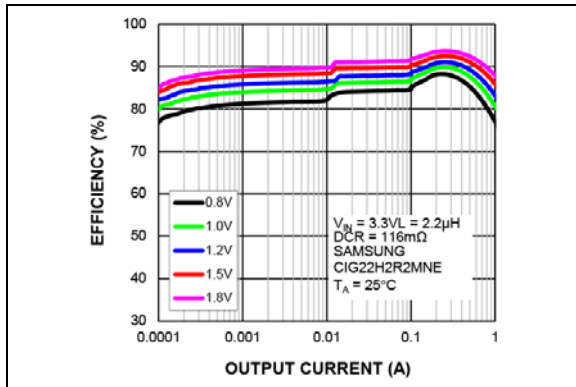


**FIGURE 2-3:** Boost Efficiency (12V) vs. Output Current.

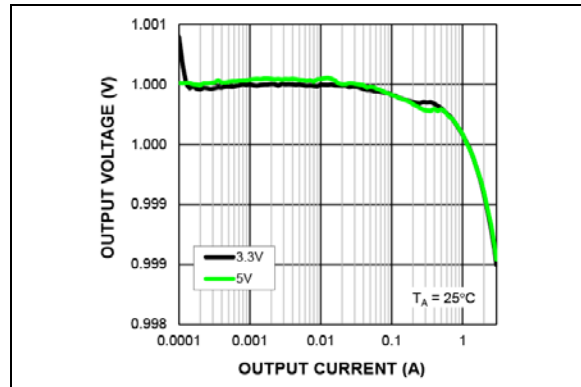


**FIGURE 2-6:** Output Voltage vs. Output Current.

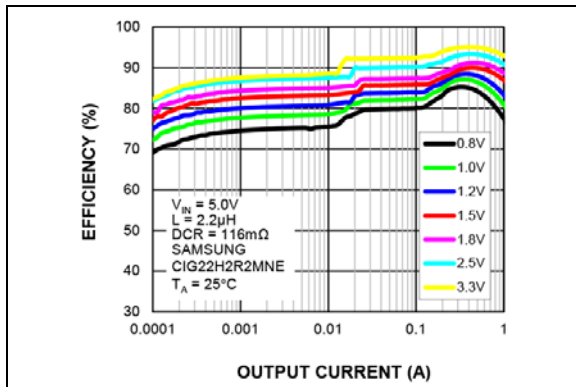
# MIC7400



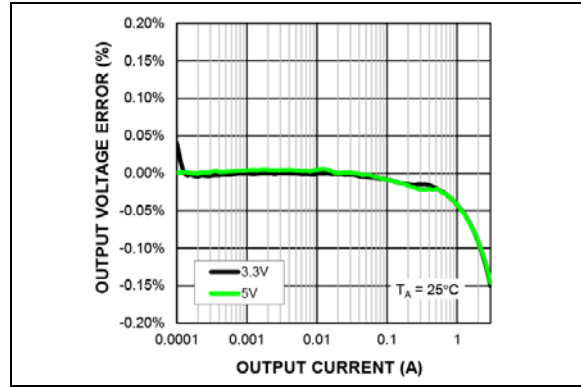
**FIGURE 2-7:** Buck Efficiency (LDCR = 116 mΩ) vs. Output Current.



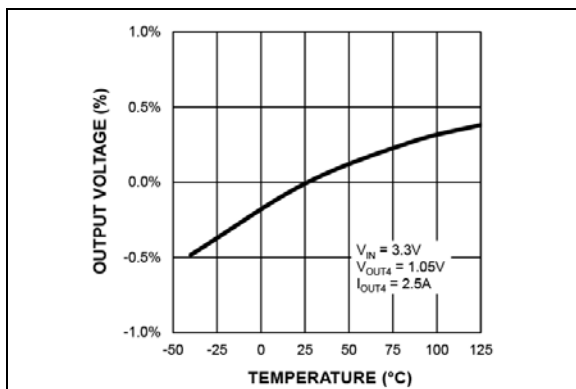
**FIGURE 2-10:** Buck Output Voltage (1.0V) vs. Output Current.



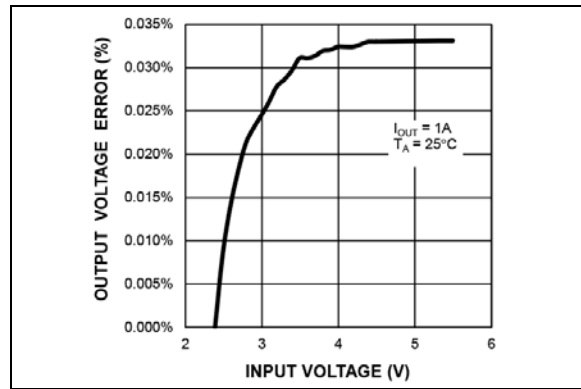
**FIGURE 2-8:** Buck Efficiency (LDCR = 116 mΩ) vs. Output Current.



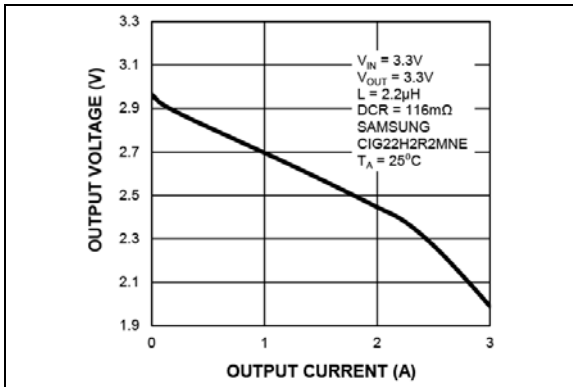
**FIGURE 2-11:** Buck Output Voltage Regulator vs. Output Current.



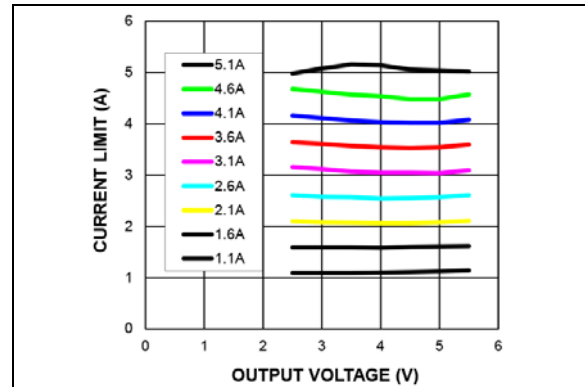
**FIGURE 2-9:** Output Voltage vs. Temperature.



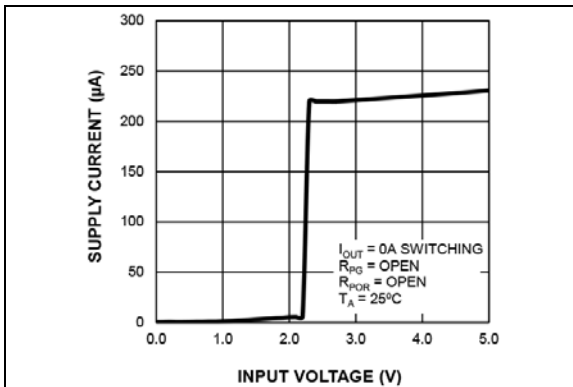
**FIGURE 2-12:** Buck Line Regulation vs. Input Voltage.



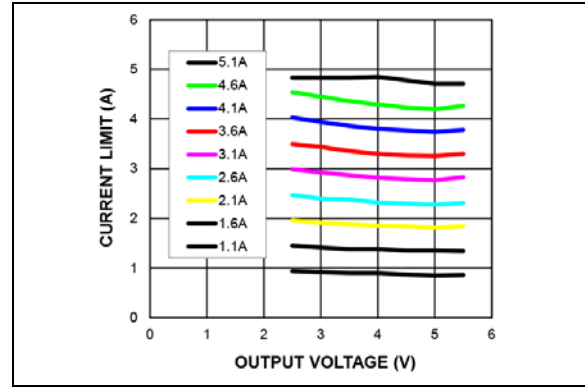
**FIGURE 2-13:** Dropout Output Voltage vs. Output Current.



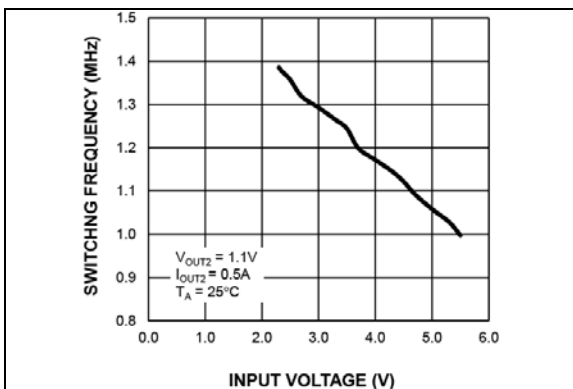
**FIGURE 2-16:** Current-Limit Threshold vs. Output Voltage.



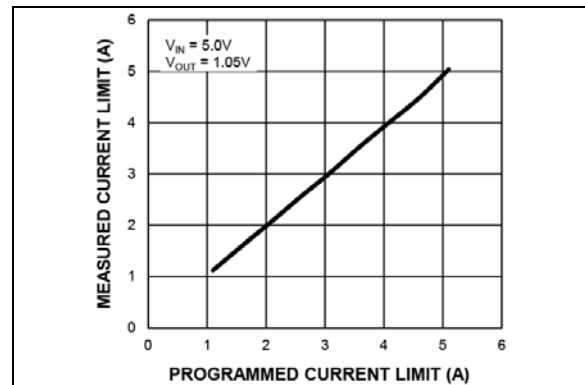
**FIGURE 2-14:**  $V_{IN}$  Operating Supply Current vs. Input Voltage.



**FIGURE 2-17:** Output Current-Limit vs. Output Voltage.

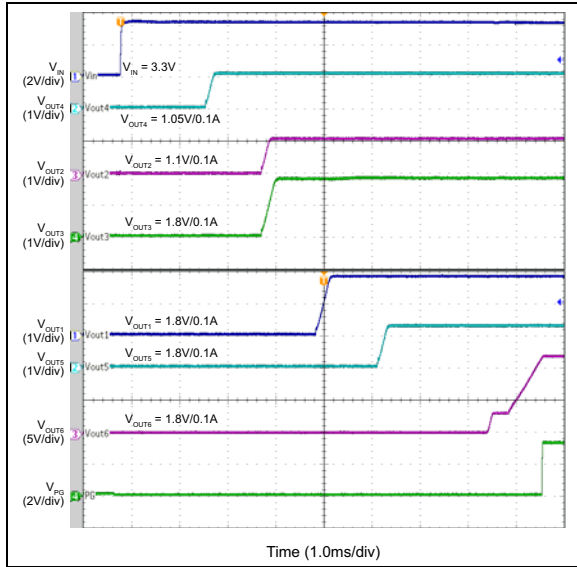


**FIGURE 2-15:** Buck 2 Switching Frequency vs. Input Voltage.

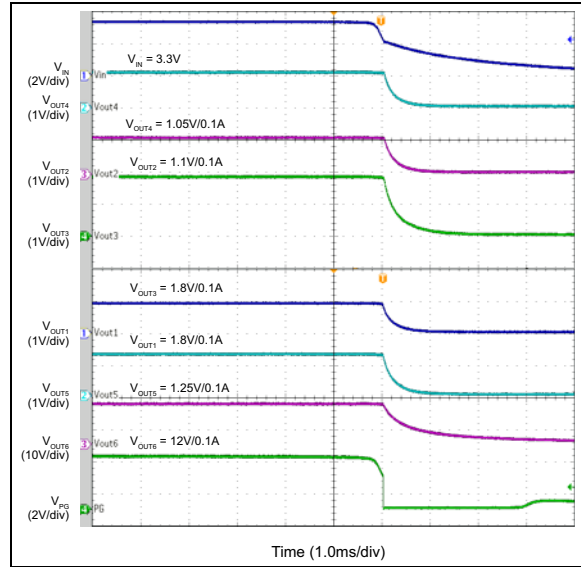


**FIGURE 2-18:** Programmed Current-Limit vs. Measured Current-Limit.

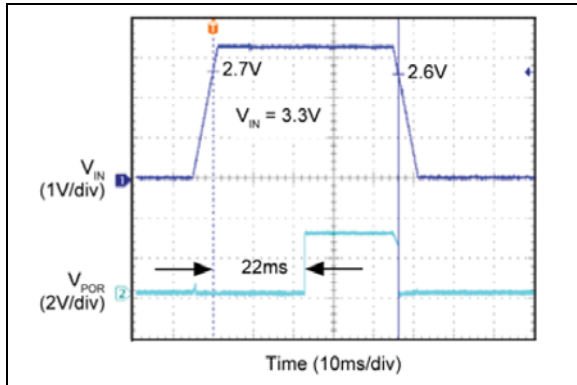
# MIC7400



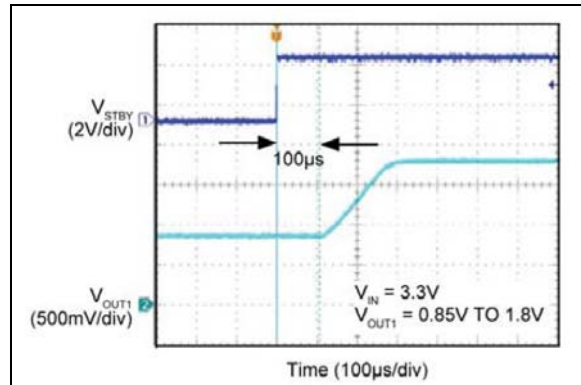
**FIGURE 2-19:** Hot Plug – Rising  $V_{IN}$ .



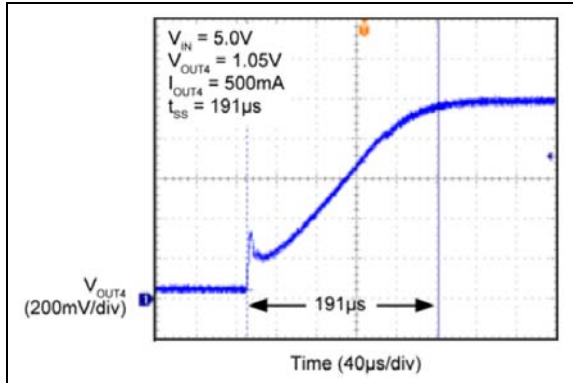
**FIGURE 2-21:** Unplug – Falling  $V_{IN}$ .



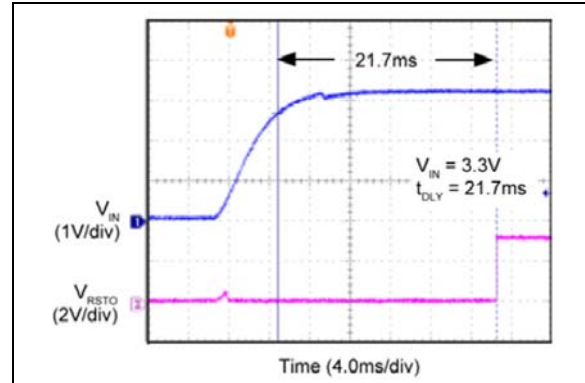
**FIGURE 2-20:** POR Timing.



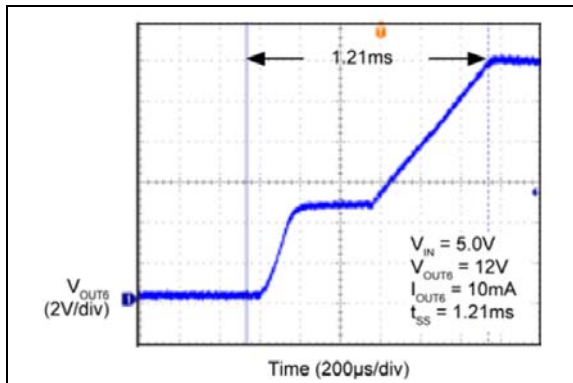
**FIGURE 2-22:** STBY Delay.



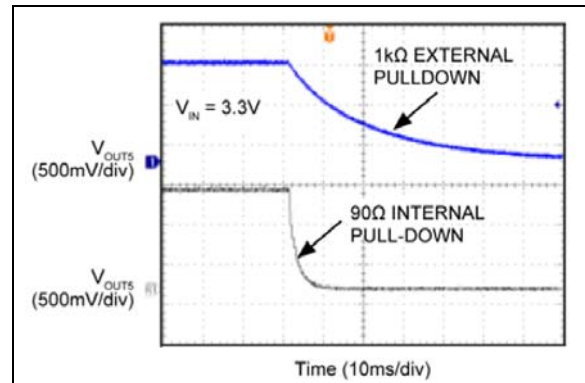
**FIGURE 2-23:** Buck Soft-Start.



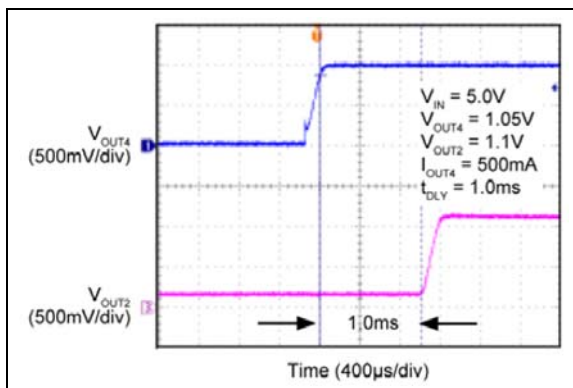
**FIGURE 2-26:** POR Delay.



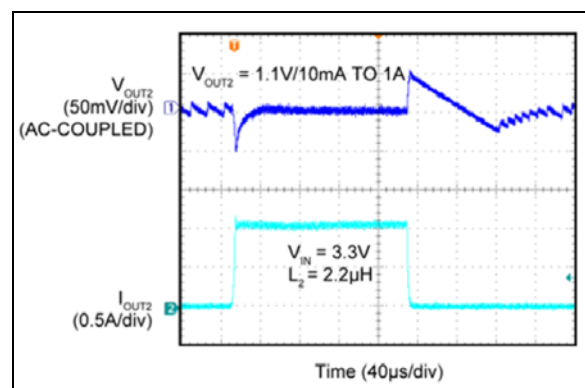
**FIGURE 2-24:** Boost Soft-Start.



**FIGURE 2-27:** Output Pull-Down Resistance.

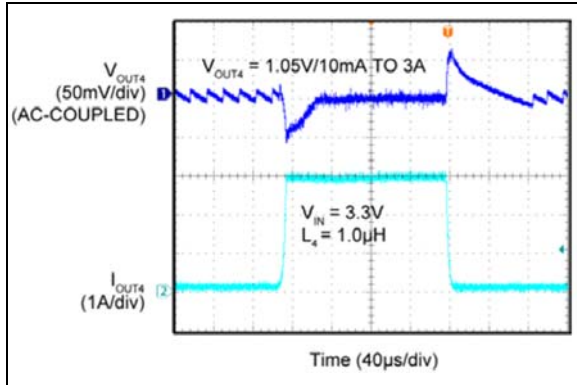


**FIGURE 2-25:** Standard Delay.

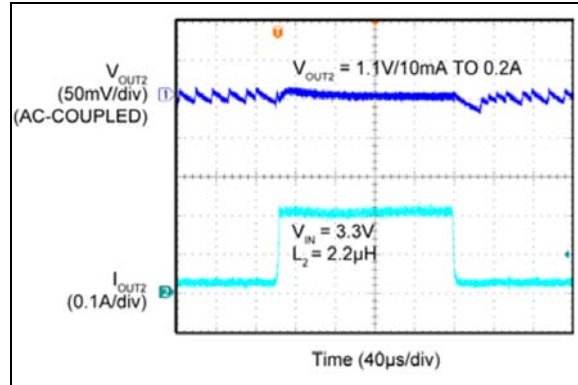


**FIGURE 2-28:** Buck 2 Load Transient – 10 mA to 1A.

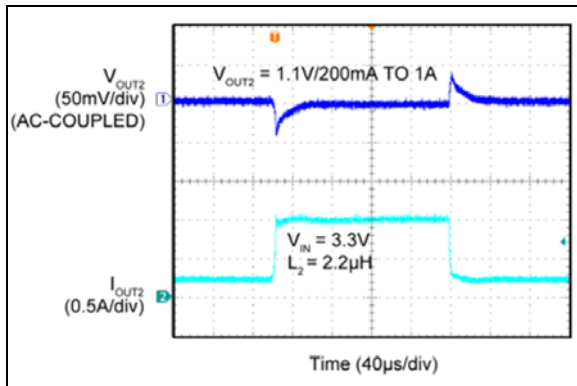
# MIC7400



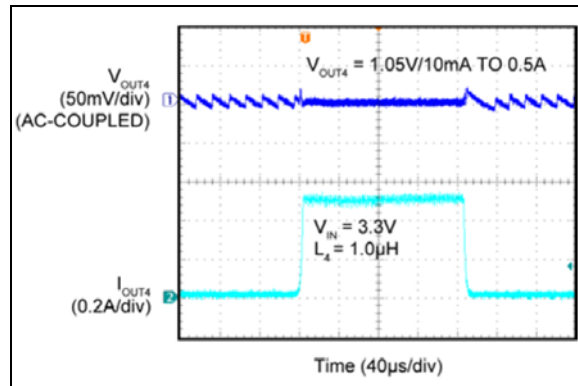
**FIGURE 2-29:** Buck 4 Load Transient – 10 mA to 3A.



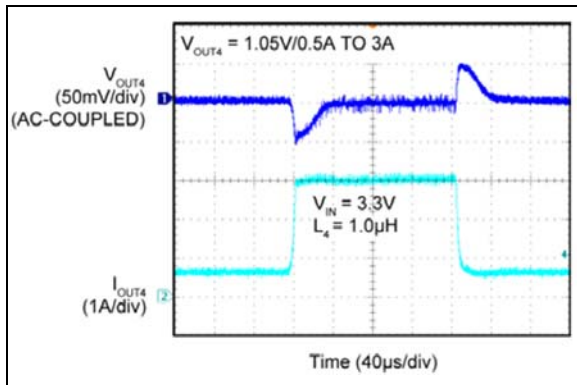
**FIGURE 2-32:** Buck 2 Load Transient – 10 mA to 0.2A.



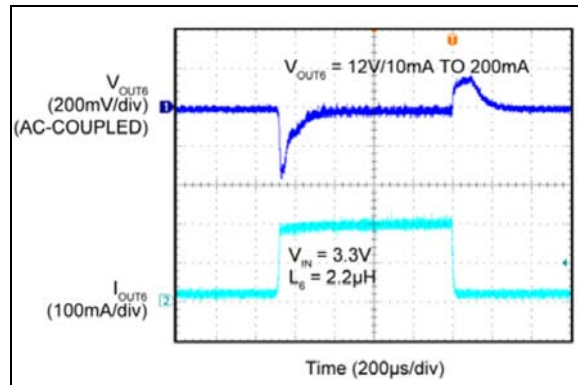
**FIGURE 2-30:** Buck 2 Load Transient – 200 mA to 1A.



**FIGURE 2-33:** Buck 4 Load Transient – 10 mA to 0.5A.

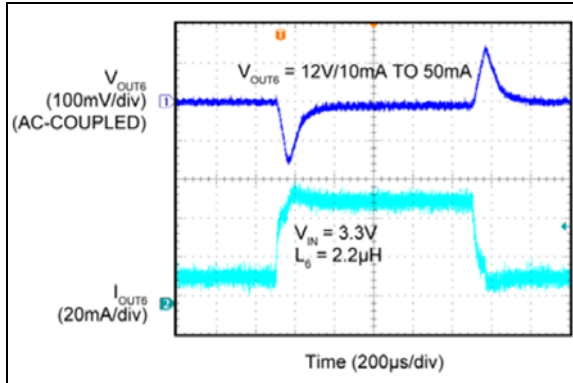


**FIGURE 2-31:** Buck 4 Load Transient – 0.5A to 3A.

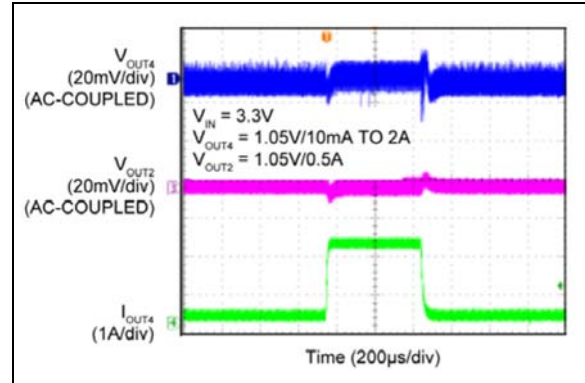


**FIGURE 2-34:** Boost 6 Load Transient – 10 mA to 200 mA.

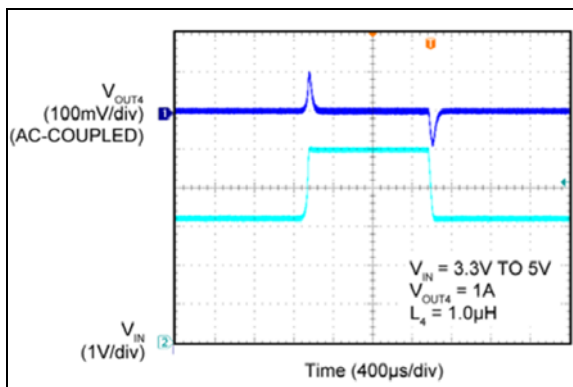




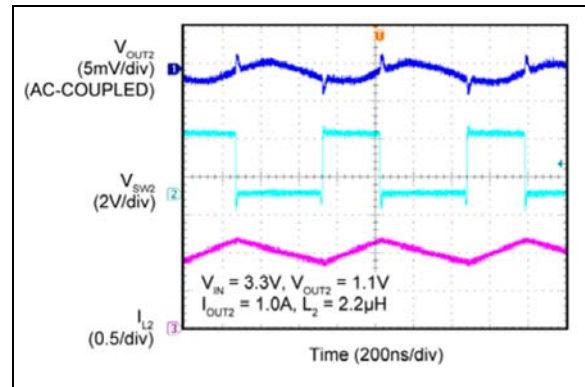
**FIGURE 2-35:** Boost 6 Load Transient – 10 mA to 50 mA.



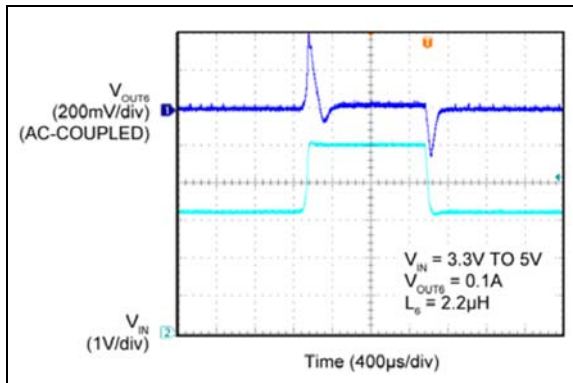
**FIGURE 2-38:** Cross Regulation.



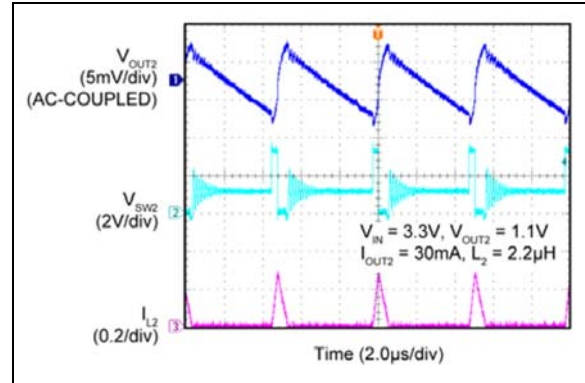
**FIGURE 2-36:** Buck 4 Line Transient – 3.3V to 5.0V.



**FIGURE 2-39:** Buck 2 PWM Switching Waveforms.

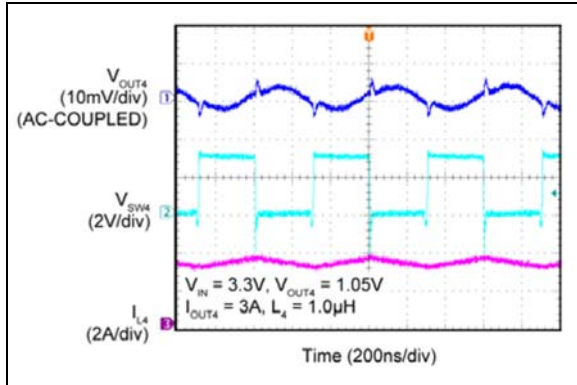


**FIGURE 2-37:** Boost 6 Line Transient – 3.3V to 5.0V.

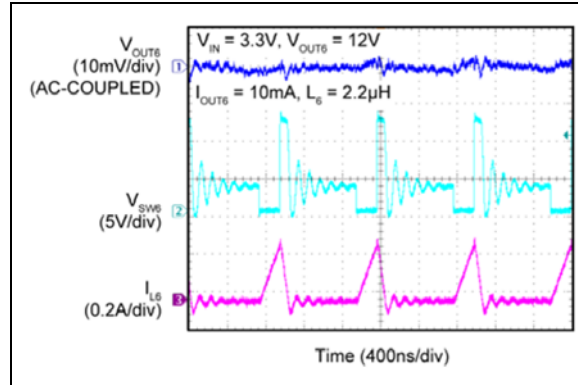


**FIGURE 2-40:** Buck 2 PFM Switching Waveforms.

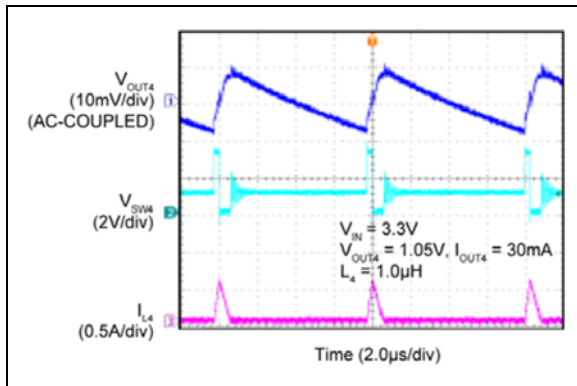
# MIC7400



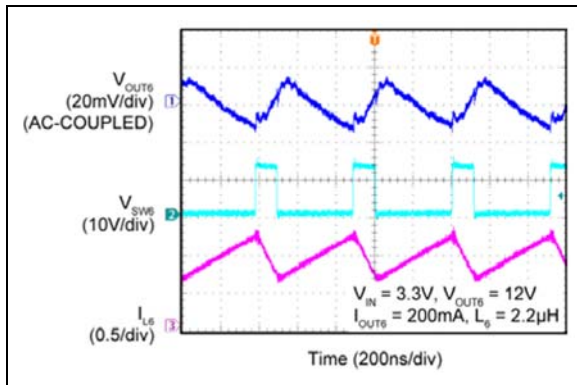
**FIGURE 2-41:** Buck 4 PWM Switching Waveforms.



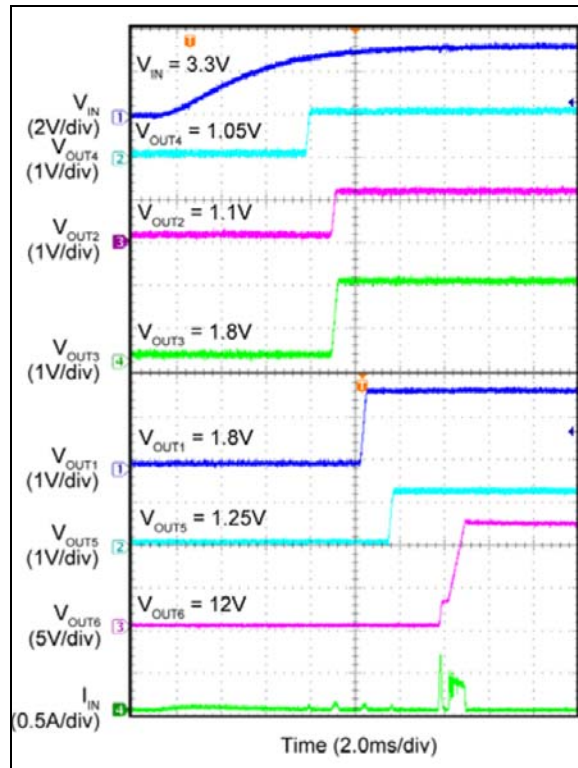
**FIGURE 2-44:** Boost 6 PFM Switching Waveforms.



**FIGURE 2-42:** Buck 4 PFM Switching Waveforms.

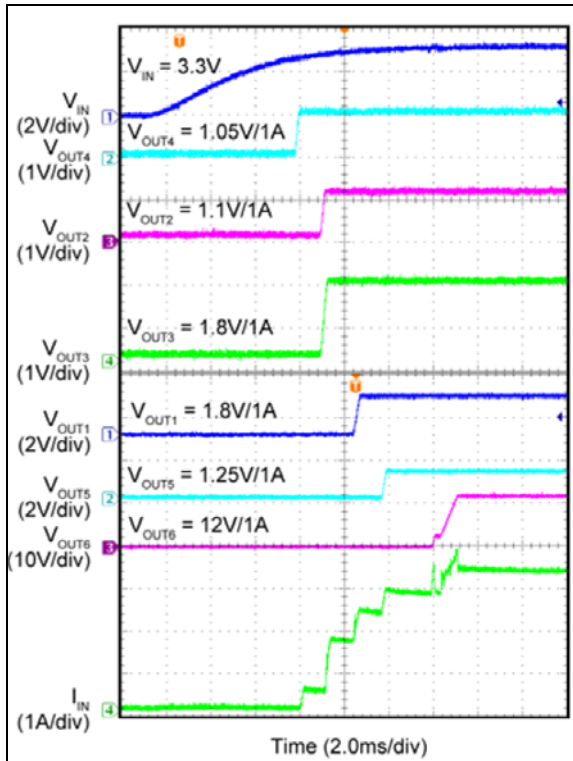


**FIGURE 2-43:** Boost 6 PWM Switching Waveforms.

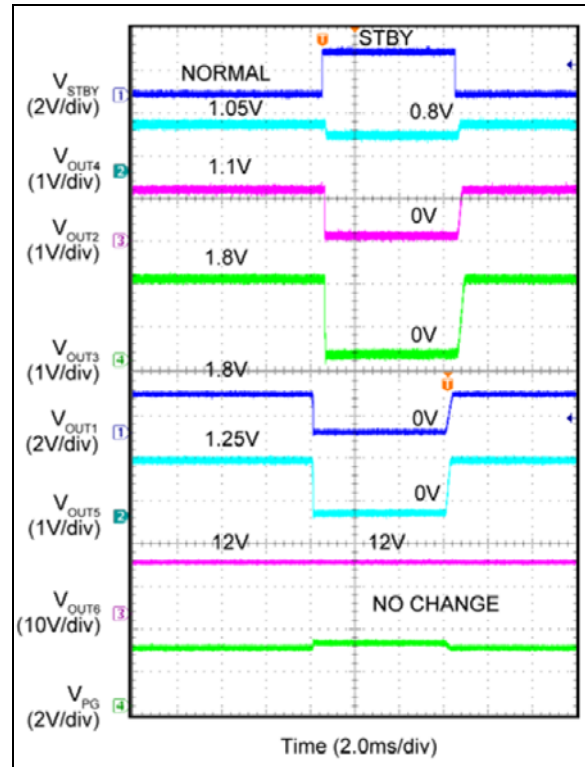


**FIGURE 2-45:** Input Supply Inrush Current – No Load.

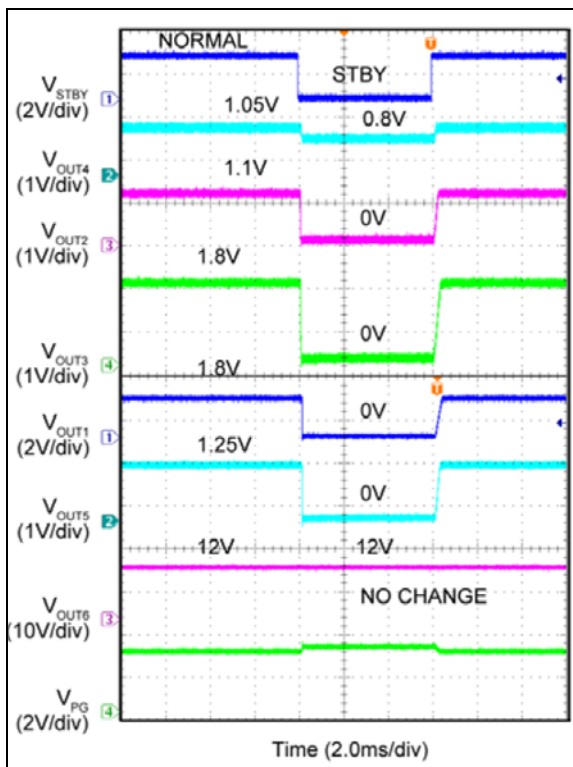




**FIGURE 2-46:** Input Supply Inrush Current – Loaded.



**FIGURE 2-48:** Rising Edge Trigger Standby.

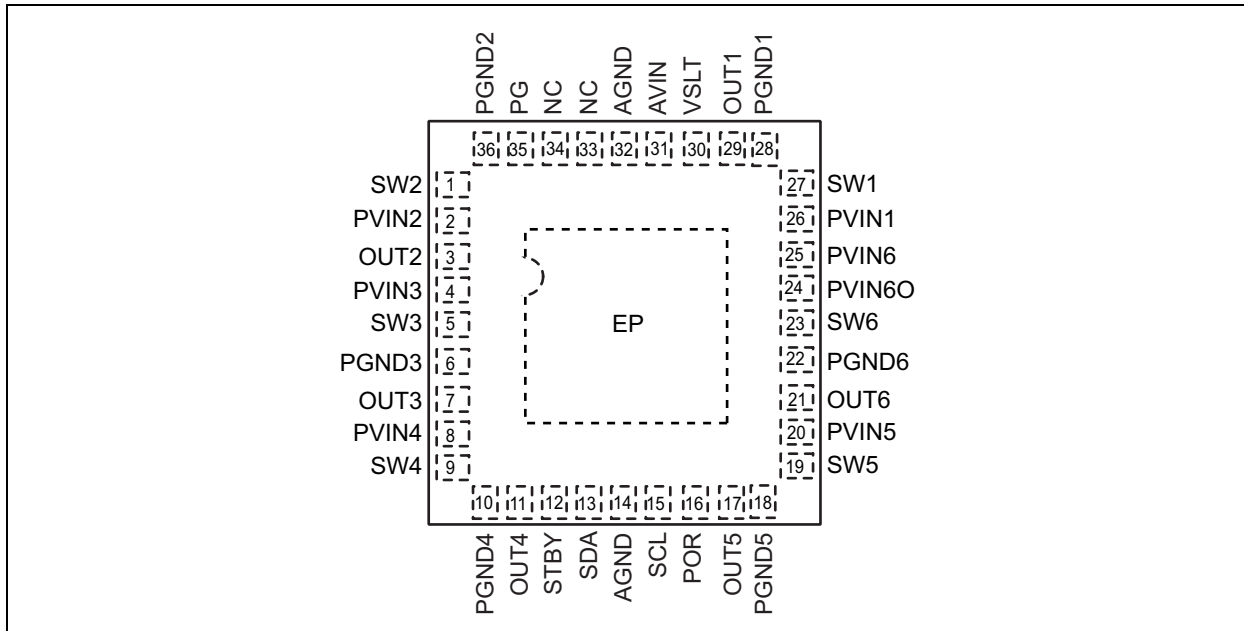


**FIGURE 2-47:** Falling Edge Trigger Standby (DEFAULT).

# MIC7400

## 3.0 PIN DESCRIPTIONS

The descriptions of the pins are listed in [Table 3-1](#).



**FIGURE 3-1:** MIC7400 Pin Configuration.

**TABLE 3-1: PIN FUNCTION TABLE**

| Pin Number | Pin Name | Description   |
|------------|----------|---|
| 1          | SW2      | Switch Pin 2 (Output): Inductor connection for the synchronous step-down regulator. Connect the inductor between the output capacitor and the SW2 pin.  |
| 2          | PVIN2    | Power Supply Voltage 2 (Input): Input supply to the source of the internal high-side P-channel MOSFET. An input capacitor between PVIN2 and the power ground PGND2 pin is required and should be placed as close as possible to the IC.   |
| 3          | OUT2     | Output Voltage Sense 2 (Input): This pin is used to sense the output voltage. Connect OUT2 as close to the output capacitor as possible to sense output voltage. Also provides the path to discharge the output through an internal 90Ω resistor when disabled. This pull-down feature is programmed through the PULLD[x] register. |
| 4          | PVIN3    | Power Supply Voltage 3 (Input): Input supply to the source of the internal high-side P-channel MOSFET. An input capacitor between PVIN3 and the power ground PGND3 pin is required and should be placed as close as possible to the IC.   |
| 5          | SW3      | Switch Pin 3 (Output): Inductor connection for the synchronous step-down regulator. Connect the inductor between the output capacitor and the SW3 pin.  |
| 6          | PGND3    | Power Ground 3: The power ground for the synchronous buck converter power stage. The PGND pin connects to the sources of the internal low-side N-Channel MOSFET, the negative terminals of input capacitors, and the negative terminals of output capacitors.   |
| 7          | OUT3     | Output Voltage Sense 3 (Input): This pin is used to sense the output voltage. Connect OUT3 as close to the output capacitor as possible to sense output voltage. Also provides the path to discharge the output through an internal 90Ω resistor when disabled. This pull-down feature is programmed through the PULLD[x] register. |
| 8          | PVIN4    | Power Supply Voltage 4 (Input): Input supply to the source of the internal high-side P-channel MOSFET. An input capacitor between PVIN4 and the power ground PGND4 pin is required and to be placed as close as possible to the IC.   |
| 9          | SW4      | Switch Pin 4 (Output): Inductor connection for the synchronous step-down regulator. Connect the inductor between the output capacitor and the SW4 pin.  |

**TABLE 3-1: PIN FUNCTION TABLE (CONTINUED)**

| Pin Number | Pin Name | Description  |
|------------|----------|--|
| 10         | PGND4    | Power Ground 4: The power ground for the synchronous buck converter power stage. The PGND pin connects to the source of the internal low-side N-Channel MOSFET, the negative terminals of input capacitors, and the negative terminals of output capacitors.   |
| 11         | OUT4     | Output Voltage Sense 4 (Input): This pin is used to sense the output voltage. Connect the OUT4 as close to the output capacitor as possible to sense output voltage. Also provides the path to discharge the output through an internal 90Ω resistor when disabled. This pull-down feature is programmed through the PULLD[x] register.  |
| 12         | STBY     | Standby Reset (Input): Standby mode allows the total power consumption to be reduced by either lowering a supply voltage or turning it off. The IC can be placed in standby mode while operating in normal mode by a high-to-low transition (DEFAULT) on the STBY input. When this occurs, the STBY_MODEB bit will be set to logic "0". Either a low-to-high transition on the STBY pin or an I <sup>2</sup> C write command to the STBY_MODEB bit sets all of the regulators to their normal mode default settings. This pin can be driven with either a digital signal or open collector output. Do not let this pin float. Connect to ground or VIN. A pull-down resistor of 100 kΩ or less can also be used. There are both a high-to-low (DEFAULT) and low-to-high normal to standby trigger options available. |
| 13         | SDA      | High-Speed Mode 3.4 MHz I <sup>2</sup> C Data (Input/Output): This is an open-drain, bidirectional data pin. Data is read on the rising edge of the SCL and data is clocked out on the falling edge of the SCL. External pull-up resistors are required.   |
| 14         | AGND     | Analog Ground: Internal signal ground for all low power circuits. Connect to ground plane for best operation.  |
| 15         | SCL      | High-Speed Mode 3.4 MHz I <sup>2</sup> C Clock (Input): I <sup>2</sup> C serial clock line open-drain input. External pull-up resistors are required.  |
| 16         | POR      | Power-on-Reset (Output): This is an open-drain output that goes high after the POR delay time elapses. The POR delay time starts as soon as the AVIN pin voltage rises above the upper threshold set by the PORUP register. The POR output goes low without delay when AVIN falls below the lower threshold set by the PORDN register.   |
| 17         | OUT5     | Output Voltage Sense 5 (Input): This pin is used to sense the output voltage. Connect OUT5 as close to the output capacitor as possible to sense output voltage. Also provides the path to discharge the output through an internal 90Ω resistor when disabled. This pull-down feature is programmed through the PULLD[x] register.  |
| 18         | PGND5    | Power Ground 5: The power ground for the synchronous buck converter power stage. The PGND pin connects to the source of the internal low-side N-Channel MOSFET, the negative terminals of input capacitors, and the negative terminals of output capacitors.   |
| 19         | SW5      | Switch Pin 5 (Output): Inductor connection for the synchronous step-down regulator. Connect the inductor between the output capacitor and the SW5 pin.   |
| 20         | PVIN5    | Power Supply Voltage 5 (Input): Input supply to the source of the internal high-side P-channel MOSFET. An input capacitor between PVIN5 and the power ground PGND5 pin is required and should be placed as close as possible to the IC.  |
| 21         | OUT6     | Output Voltage 6 Sense (Input): This pin is used to sense the output voltage. Connect OUT6 as close to the output capacitor as possible to sense output voltage. Also provides the path to discharge the output through an internal programmable current source when disabled. This pull-down feature is programmed through the PULLD[x] register.   |
| 22         | PGND6    | Power Ground 6: The power ground for the boost converter power stage. The PGND pin connects to the source of the internal low-side N-Channel MOSFET, the negative terminals of input capacitors, and the negative terminals of output capacitors.  |
| 23         | SW6      | Switch Pin 6 (Input): Inductor connection for the boost regulator. Connect the inductor between the PVIN6O and SW6 pin.  |

# MIC7400

**TABLE 3-1: PIN FUNCTION TABLE (CONTINUED)**

| Pin Number | Pin Name | Description   |
|------------|----------|---|
| 24         | PVIN6O   | Power Supply Voltage 6 (Output): This pin is the output of the power disconnect switch for the boost regulator. When the boost regulator is on, an internal switch provides a current path for the boost inductor. In shutdown, an internal P-channel MOSFET is turned off and disconnects the boost output from the input supply. This feature eliminates current draw from the input supply during shutdown. An input capacitor between PVIN6O and the power ground PGND6 pin is required and place as close as possible to the IC.   |
| 25         | PVIN6    | Power Supply Voltage 6 (Input): Input supply to the internal disconnect switch.   |
| 26         | PVIN1    | Power Supply Voltage 1 (Input): Input supply to the source of the internal high-side P-channel MOSFET. An input capacitor between PVIN1 and the power ground PGND1 pin is required and should be placed as close as possible to the IC.   |
| 27         | SW1      | Switch Pin 1 (Output): Inductor connection for the synchronous step-down regulator. Connect the inductor between the output capacitor and the SW1 pin.  |
| 28         | PGND1    | Power Ground 1: The power ground for the synchronous buck converter power stage. The PGND pin connects to the source of the internal low-side N-Channel MOSFET, the negative terminals of input capacitors, and the negative terminals of output capacitors.  |
| 29         | OUT1     | Output Voltage Sense 1 (Input): This pin is used to sense the output voltage remotely. Connect OUT1 as close to output capacitor as possible to sense output voltage. This feature also provides the path to discharge the output through an internal 90Ω resistor when disabled. The pull-down feature is programmed through the PULLD[x] register.  |
| 30         | VSLT     | POR Selection Threshold (Input): A high on this pin sets the PORUP and PORDN registers to their upper threshold limits and a low to their lower threshold limits. Do not leave floating.  |
| 31         | AVIN     | Analog Voltage Supply (Input): The start-up sequence begins as soon as the AVIN pin voltage rises above the IC's UVLO upper threshold. The outputs do not turn off until AVIN pin voltage falls below the lower threshold limit. A 2.2 μF ceramic capacitor from the AVIN pin to AGND pin must be placed next to the IC.  |
| 32         | AGND     | Analog Ground: Internal signal ground for all low power circuits. Connect directly to the layer 2 ground plane. Layer 2 is the point where all the PGNDs and AGND are connected. Do not connect PGND and AGND together on the top layer.  |
| 33         | NC       | No Connect. Must be left floating.  |
| 34         | NC       | No Connect. Must be left floating.  |
| 35         | PG       | Global Power Good (Output): This is an open-drain output that is pulled high when all the regulator power good flags are high. If an output falls below the power good threshold or a thermal fault occurs, the global power good flag is pulled low. There is a falling edge de-glitch time of 50 μs to prevent false triggering on output voltage transients. A power good mask feature programmed through the PGOOD_MASK[x] registers can be used to ignore a power good fault. When masked an individual power good fault will not cause the global power good output to de-assert. Do not connect the power good pull-up resistor to a voltage higher than AVIN. |
| 36         | PGND2    | Power Ground 2: The power ground for the synchronous buck converter power stage. The PGND pin connects to the source of the internal low-side N-Channel MOSFET, the negative terminals of input capacitors, and the negative terminals of output capacitors.  |
| EP         | ePAD     | Exposed Pad: Must be connected to the GND plane for full output power to be realized.   |

## 4.0 FUNCTIONAL DESCRIPTION

The MIC7400 is one of the industry's most-advanced PMIC designed for solid state drives (SSD) on the market today. It is a multi-channel solution that offers software-configurable soft-start, sequencing, and digital voltage control (DVC) that minimizes PC board area. These features usually require a pin for programming. However, this approach makes the IC larger by increasing pin count, and also increases BOM cost due to the external components.

The following is a complete list of programmable features:

- Buck output voltage (0.8V – 3.3V/50 mV steps)
- Boost output voltage (7.0V – 14V/ 200 mV steps)
- Power-on-reset (2.25V – 4.25V/50 mV steps)
- Power-on-reset delay (5 ms – 160 ms/5 ms steps)
- Power-up sequencing (6 time slots)
- Power-up sequencing delay (0 ms – 7 ms/1 ms steps)
- Soft-start (4  $\mu$ s – 1024  $\mu$ s per step)
- Buck current limit threshold
  - (1.1A to 6.1A/0.5A steps)
- Boost current limit threshold
  - (1.76A to 2.6A/0.12A steps)
- Boost pull-down (37 mA to 148 mA/37 mA steps)
- Buck pull-down (90 $\Omega$ )
- Buck standby output voltage programmable
- Buck standby programmable standby current limit
- Boost standby output voltage programmable
- Boost standby programmable standby current limit
- Global power good masking

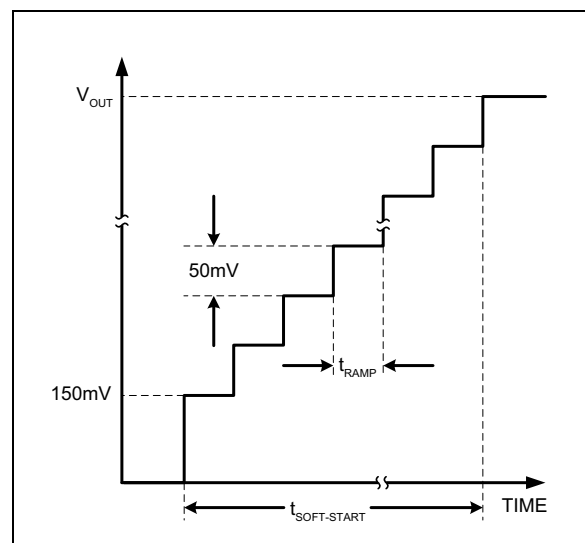
These features give the system designer the flexibility to customize the MIC7400 for their application. For example,  $V_{OUT1}$  current-limit can be programmed to 4.1A and  $V_{OUT2}$  can be set to 1.1A. These outputs can be programmed to come up at the same time or 2.0 ms apart. In addition, in power-saving standby mode, the outputs can either be turned off or programmed to a lower voltage. With this programmability, the MIC7400 can be used in multiple platforms.

The MIC7400 buck regulators are adaptive on-time synchronous step-down DC-to-DC regulators. They are designed to operate over a wide input voltage range from 2.4V to 5.5V and provide a regulated output voltage at up to 3.0A of output current. An adaptive on-time control scheme is employed to obtain a constant switching frequency and to simplify the control compensation. The device includes an internal soft-start function which reduces the power supply input surge current at start-up by controlling the output voltage rise time.

The MIC7400 has a current-mode boost regulator that can deliver up to 200 mA of output current and only consumes 70  $\mu$ A of quiescent current. The 2.0 MHz switching frequency allows small chip inductors to be used. Programmable overcurrent sensing protects the boost from overloads and an output disconnect switch opens to protect against a short-circuit condition. Soft-start is also programmable and controls both the rising and falling output.

## 4.1 Programmable Buck Soft-Start Control

The MIC7400 soft-start feature forces the output voltage to rise gradually, which limits the inrush current during start-up. A slower output rise time will draw a lower input surge current. The soft-start time is based on the least significant bit (LSB) of an internal DAC and the speed of the ramp rate, as shown in [Figure 4-1](#). This illustrates the soft-start waveform for all five synchronous buck converters. The initial step starts at 150 mV and each subsequent step is 50 mV.



**FIGURE 4-1:** Buck Soft-Start.

The output ramp rate ( $t_{RAMP}$ ) is set by the soft-start registers. Each output ramp rate can be individually set from 4  $\mu$ s to 1024  $\mu$ s, see [Table 4-1](#) for details.

The soft-start time  $t_{SS}$  can be calculated by [Equation 4-1](#):

### EQUATION 4-1:

$$t_{SS} = \left( \frac{V_{OUT} - 0.15V}{50mV} \right) \times t_{RAMP}$$

Where:

$t_{SS}$  = Output rise time.

$V_{OUT}$  = Output voltage.

$t_{RAMP}$  = Output dwell time.

# MIC7400

For example:

## EQUATION 4-2:

$$t_{SS} = \left( \frac{1.8V - 0.15V}{50mV} \right) \times 8\mu s$$

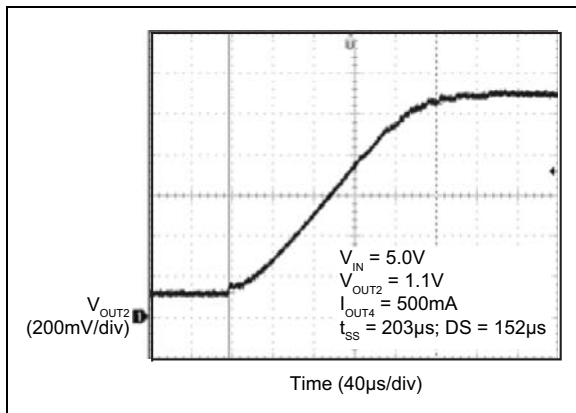
$$t_{SS} = 264\mu s$$

Where:  
 $V_{OUT} = 1.8V$   
 $t_{RAMP} = 8.0\mu s$

**TABLE 4-1: BUCK OUTPUTS DEFAULT SOFT-START TIME (DEFAULT)**

| —          | $V_{OUT}$ | $t_{RAMP}$ | $t_{SS}$    |
|------------|-----------|------------|-------------|
| $V_{OUT1}$ | 1.8V      | 8 $\mu s$  | 264 $\mu s$ |
| $V_{OUT2}$ | 1.1V      | 8 $\mu s$  | 152 $\mu s$ |
| $V_{OUT3}$ | 1.8V      | 8 $\mu s$  | 264 $\mu s$ |
| $V_{OUT4}$ | 1.05V     | 8 $\mu s$  | 144 $\mu s$ |
| $V_{OUT5}$ | 1.25V     | 8 $\mu s$  | 176 $\mu s$ |

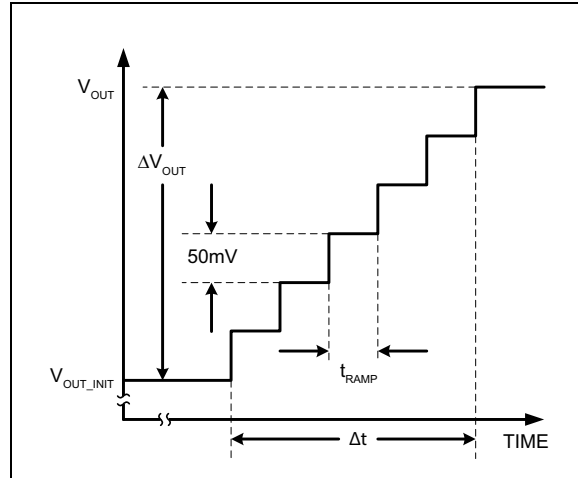
Figure 4-2 shows the output of Buck 1 ramping up cleanly, starting from 0.15V to its final 1.1V value.



**FIGURE 4-2: Buck Soft-Start.**

## 4.2 Buck Digital Voltage Control (DVC)

The output voltage has a 6-bit control DAC that can be programmed from 0.8V to 3.3V in 50 mV increments. If the output is programmed to a higher voltage, then the output ramps up, as shown in Figure 4-3.



**FIGURE 4-3: Buck DVC Control Ramp.**

The ramp time is determined by Equation 4-3:

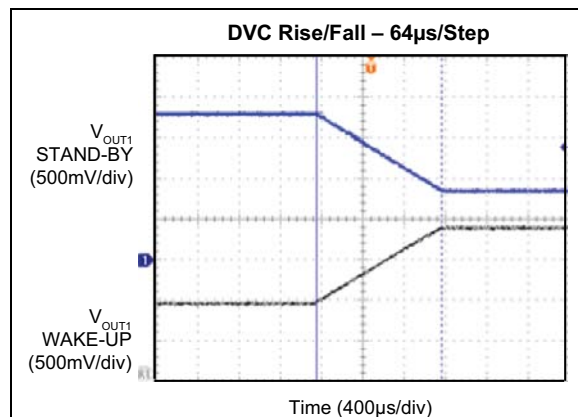
## EQUATION 4-3:

$$\Delta t = \left( \frac{V_{OUT} - V_{OUT\_INIT}}{50mV} \right) \times t_{RAMP}$$

Where:  
 $V_{OUT\_INIT}$  = Initial output voltage.  
 $V_{OUT}$  = Final output voltage.  
 $t_{RAMP}$  = Output dwell time.

When the regulator is programmed to a lower voltage, then the output voltage ramps down at a rate determined by the output ramp rate ( $t_{RAMP}$ ), the output capacitance and the external load. Small loads result in slow output voltage decay and heavy loads cause the decay to be controlled by the DAC ramp rate.

In Figure 4-4,  $V_{OUT1}$  is switched to stand-by mode with an I<sup>2</sup>C command and then switched back to normal mode either by an I<sup>2</sup>C command or a low-to-high transition of the STBY pin. In this case, the rise and fall times are the same due to a 1A load on  $V_{OUT1}$ .

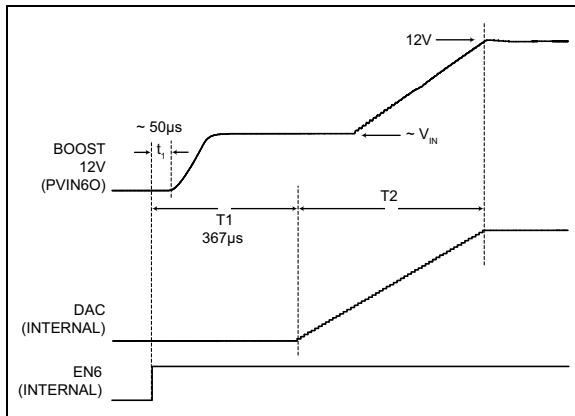


**FIGURE 4-4:** Buck DVC Control Ramp.

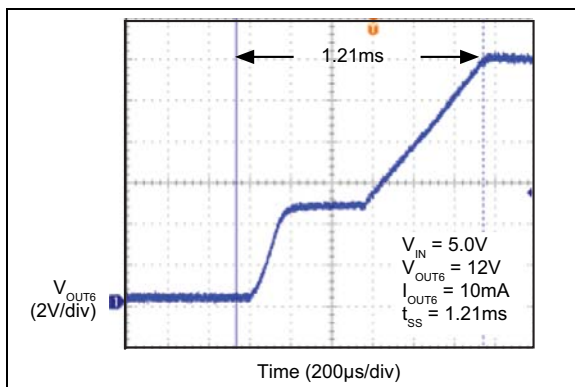
### 4.3 Programmable Boost Soft-Start Control

The boost soft-start time is divided into two parts as shown in Figure 4-5. T1 is a fixed 367  $\mu$ s delay starting from when the internal enable goes high. This delay gives enough time for the disconnect switch to turn on and bring the inductor voltage to  $V_{IN}$  before the boost is turned on. There is a 50  $\mu$ s delay that is controlled by the parasitic capacitance ( $C_{GD}$ ) of the disconnect switch before the output starts to rise.

After the T1 period, the DAC output ramp starts, T2. The total soft-start time,  $t_{SS}$ , is the sum of both periods. Figure 4-6 displays the actual boost soft-start waveform.



**FIGURE 4-5:** Boost Soft-Start Ramp.



**FIGURE 4-6:** Boost Soft-Start.

**EQUATION 4-4:**

$$t_{SS} = T1 + T2$$

$$T2 = \left( \frac{V_{OUT} - 1.4V}{0.2V} \right) \times t_{RAMP}$$

$$T2 = \left( \frac{12V - 1.4V}{0.2V} \right) \times 16\mu s$$

Where:

T1 = 367  $\mu$ s

T2 = 848  $\mu$ s

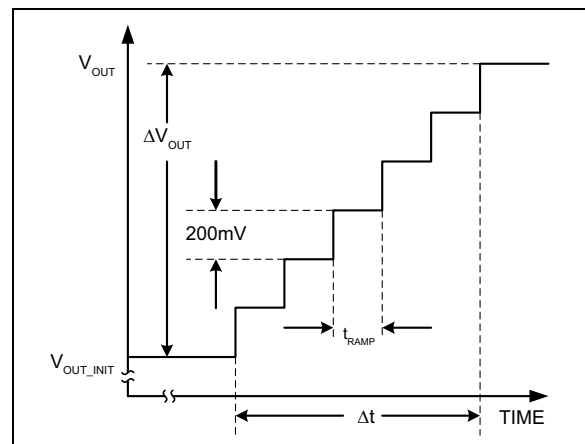
$t_{SS} = 367 \mu s + 848 \mu s = 1.215 ms$

$V_{OUT}$  = Output voltage.

$t_{RAMP}$  = Output dwell time = 16  $\mu$ s.

### 4.4 Boost Digital Voltage Control (DVC)

The boost output control works the same way as the buck, except that the voltage steps are 200 mV, see Figure 4-7. When the boost is programmed to a lower voltage the output ramps down at a rate determined by the output ramp rate ( $t_{RAMP}$ ), the output capacitance and the external load. During both the ramp up and down time, the power good output is blanked and if the power good mask bit is set to “1”.



**FIGURE 4-7:** Boost DVC Control Ramp.

The ramp time can be computed using the following equation:



**EQUATION 4-5:**

$$\Delta t = \left( \frac{V_{OUT} - V_{OUT\_INIT}}{0.2V} \right) \times t_{RAMP}$$

Where:  
 $V_{OUT\_INIT}$  = Initial output voltage.

**TABLE 4-2: BOOST OUTPUT DEFAULT SOFT-START TIME**

| —          | $V_{OUT}$ | $t_{RAMP}$ | $t_{SS}$ |
|------------|-----------|------------|----------|
| $V_{OUT6}$ | 12V       | 16 $\mu$ s | 1.215 ms |

## 4.5 Buck Current-Limit

The MIC7400 buck regulators have high-side current-limiting that can be varied by a 4-bit code. If the regulator remains in current-limit for more than seven consecutive PWM cycles, the output is latched off, the overcurrent status register bit is set to 1, the power-good status register bit is set to 0 and the global power good (PG) output pin is pulled low. An overcurrent fault on one output will not disable the remaining outputs. [Table 4-3](#) shows the current-limit register settings versus output current. The current-limit register setting is set at twice the maximum output current.

**TABLE 4-3: BUCK CURRENT-LIMIT REGISTER SETTINGS**

| $I_{OUT(MAX)}$ | $I_{PROG}$ | BINARY | HEX |
|----------------|------------|--------|-----|
| 0.5A           | 1.1A       | 1111   | F'h |
| 1.0A           | 2.1A       | 1101   | D'h |
| 1.5A           | 3.1A       | 1011   | B'h |
| 2.0A           | 4.1A       | 1001   | 9'h |
| 2.5A           | 5.1A       | 0111   | 7'h |
| 3.0A           | 6.1A       | 0101   | 5'h |

The output can be turned back on by recycling the input power or by software control. To clear the overcurrent fault by software control, set the enable register bit to "0" then clear the overcurrent fault by setting the fault register bit to "0". This will clear the overcurrent and power good status registers. Now the output can be re-enabled by setting the enable register bit to "1".

During start-up sequencing, once an overcurrent condition is sensed, the fault register is set to "1" and the start-up sequence will stop and no further outputs will be enabled. See [Figure 4-9](#) for default start-up sequence.

## 4.6 Boost Current-Limit

The boost current-limit features cycle-by-cycle protection. The duty cycle is cut immediately once the current-limit is hit. When the boost current-limit is hit for five consecutive cycles, the FAULT signal is asserted and remains asserted with the boost converter keeping on running until the boost is powered off.

This protects the boost in normal overload conditions, but not in a short-to-ground case. For a short-circuit to ground, the boost current-limit will not be able to limit the inductor current. This short-circuit condition is sensed by the current in the disconnect switch. When the disconnect switch current limit is hit for four consecutive master clock cycles (2 MHz), regardless if the boost is switching or not, both the disconnect switch and boost are latched off automatically and the FAULT signal is asserted.

The output can be turned back on by recycling the input power or by software control. To clear the overcurrent fault by software control, set the enable register bit to "0" then clear the overcurrent fault by setting the fault register bit to "0".



## 4.7 Global Power Good Pin

The global power-good output indicates that all the outputs are above the 91% limit after the power-up sequence is completed. Once the power-up sequence is complete, the global power good output stays high unless an output falls below its power-good limit, a thermal fault occurs, the input voltage drops below the lower UVLO threshold or an output is turned OFF by setting the enable register bit to “0” unless the PGOOD\_MASK[x] bit is set to “1” (Default).

A power-good mask bit can be used to control the global power good output. The power-good mask feature is programmed through the PGOOD\_MASK[x] registers and is used to ignore an individual power-good fault. When masked, PGOOD\_MASK[x] bit is set to “1”, an individual power good fault will not cause the global power good output to de-assert.

If all the PGOOD\_MASK[x] bits are set to “1”, then the power good output de-asserts as soon as the first output starts to rise. The PGOOD\_MASK[x] bit of the last output must be set to “0” to have the PG output stay low until the last output reaches 91% of its final value.

The global power-good output is an open-drain output. A pull-up resistor can be connected to  $V_{IN}$  or  $V_{OUT}$ . Do not connect the pull-up resistor to a voltage higher than  $AV_{IN}$ .

## 4.8 Standard Delay

There is a programmable timer that is used to set the standard delay time between each time slot. The timer starts as soon as the previous time slot’s output power good goes high. When the delay completes, the regulators assigned to that time slot are enabled, see Figure 4-8.

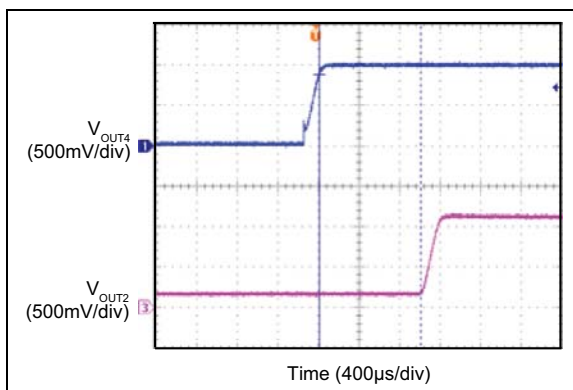


FIGURE 4-8: Standard Delay Time.

## 4.9 Power-Up Sequencing

When power is first applied to the MIC7400, all I<sup>2</sup>C registers are loaded with their default values from the EEPROM. There is about a 1.5 ms delay before the first regulator is enabled while the MIC7400 goes

through the initialization process. The DELAY register’s STDEL bits set the delay between powering up each regulator at initial power up.

The sequencing registers allow the outputs to come up in any order. There are six time slots that an output can be configured to power up in. Each time slot can be programmed for up to six regulators to be turned on at once or none at all.

Figure 4-9 shows an example of this feature.  $V_{OUT4}$  is enabled in time slot 1. After a 1 ms delay,  $V_{OUT2}$  and  $V_{OUT3}$  are enabled at the same time in time slot 2. The 1 ms is the standard delay for all of the outputs and can be programmed from 0 ms to 7 ms in 1 ms steps. Next,  $V_{OUT1}$  is powered up in time slot 3 and  $V_{OUT5}$  in time slot 4. There are no regulators programmed for time slot 5. Finally,  $V_{OUT6}$  is powered up in time slot 6. The global power good output,  $V_{PG}$ , goes high as soon as the last output reaches 91% of its final value.

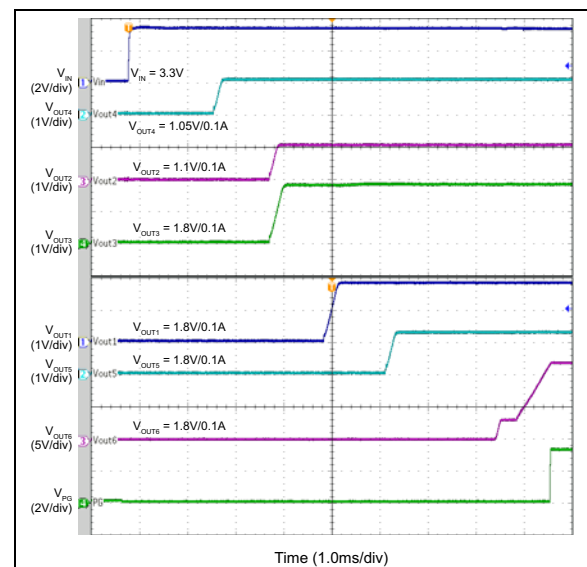


FIGURE 4-9: Hot Plug –  $V_{IN}$  Rising.

## 4.10 VSLT Pin

The power-on-reset threshold toggles between two different ranges by driving the VSLT pin high or low. The lower range of 2.25V to 3.25V is selected when the VSLT pin is tied to ground. The upper range, 3.25V to 4.25V, is selected when the VSLT pin is tied to  $V_{IN}$ .

## 4.11 Programmable Power-on-Reset (POR) Delay

The POR output pin provides the user with a way to let the SOC know that the input power is failing. If the input voltage falls below the power-on reset lower threshold level, the POR output immediately goes low. The lower threshold is set in the PORDN register and the upper threshold uses PORUP register.

# MIC7400

The low-to-high POR transition can be delayed from 5 ms to 160 ms in 5 ms increments. This feature can be used to signal the SOC that the power supplies are stable. The PORDEL register sets the delay of the POR pin. The POR delay starts as soon as the AVIN pin voltage rises above the power-on reset upper threshold limit. Figure 4-10 shows the POR operation.

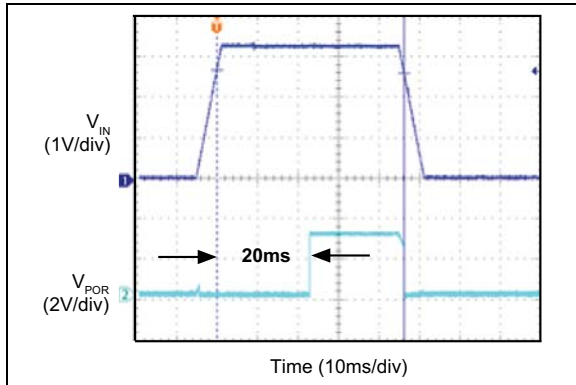


FIGURE 4-10: POR.

## 4.12 Power-Down Sequencing

When power is removed from  $V_{IN}$ , all the regulators try to maintain the output voltage until the input voltage falls below the UVLO limit of 2.35V as shown in Figure 4-11.

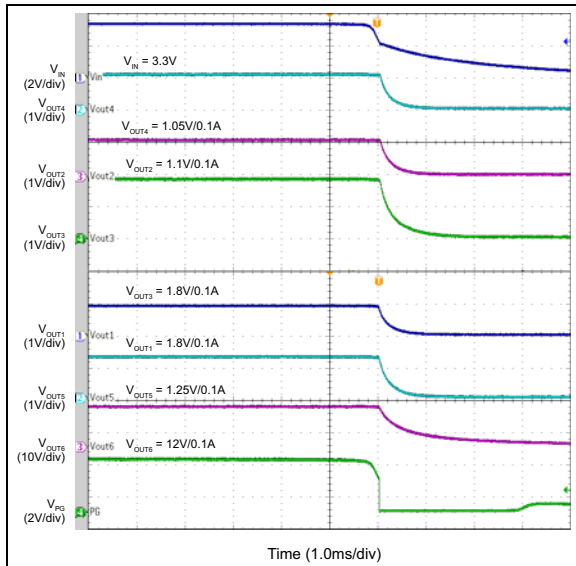


FIGURE 4-11: Hot Unplug –  $V_{IN}$  Falling.

## 4.13 Stand-By Mode

In stand-by mode, efficiency can be improved by lowering the output voltage to the standby mode value or turning an output off completely. There are two registers used for setting the output voltage, normal-mode register and stand-by mode register. The default power-up voltages are set in the normal-mode registers.

An I<sup>2</sup>C write command to the STBY\_CTRL\_REG register or the STBY pin can be used to set the MIC7400 into stand-by mode. Figure 4-12 shows an I<sup>2</sup>C write command implementation. In stand-by mode, the output can be programmed to a lower voltage or turned completely off. When disabled, the output will be soft-discharged to zero if the PULLD[1-6] register are set to 1. If PULLD[x] = 0 the output drifts to PGND at a rate determined by the load current and output capacitance.

In stand-by, if an output is disabled, the global power good output is not affected when the PGOOD\_MASK[x] is set to logic 1. If the PGOOD\_MASK[x] is set to logic 0, then the global power good flag is pulled low. In Figure 4-12, all the PGOOD\_MASK[x] bits are set to logic 1.

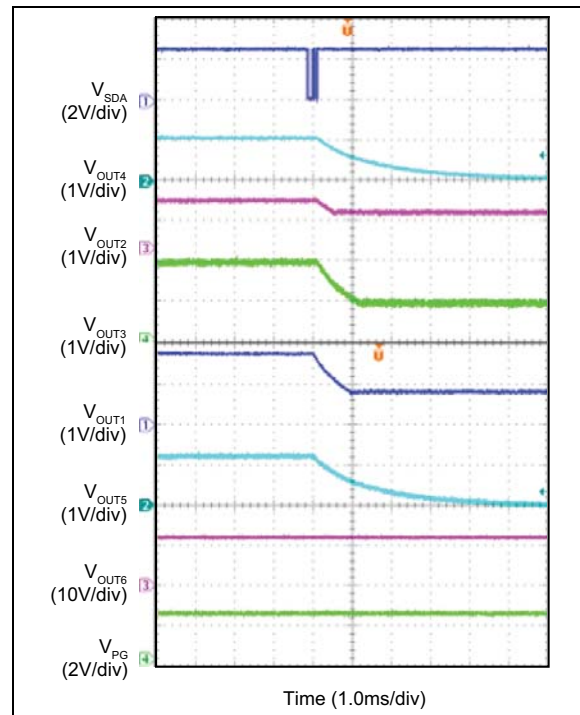
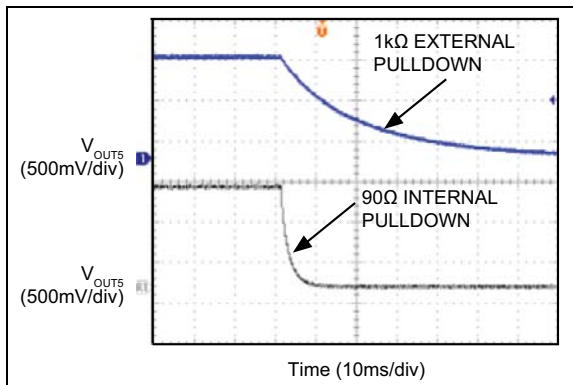


FIGURE 4-12: I<sup>2</sup>C Stand-by Mode.

## 4.14 Resistive Discharge

To ensure a known output condition in stand-by mode, the output is actively discharged to ground if the output is disabled. Setting the buck pull down register field PULLD[1-5] = 1 connects a 90Ω pull down resistor from OUT[x] to PGND[x] when the MIC7400 is disabled. If PULLD[x] = 0 the output drifts to PGND at a rate determined by the load current and the output capacitance value. The boost has a programmable pull-down current level from 37 mA to 148 mA. In Figure 4-13, the top trace shows the normal pull down and the bottom trace is with the 90Ω pull-down.

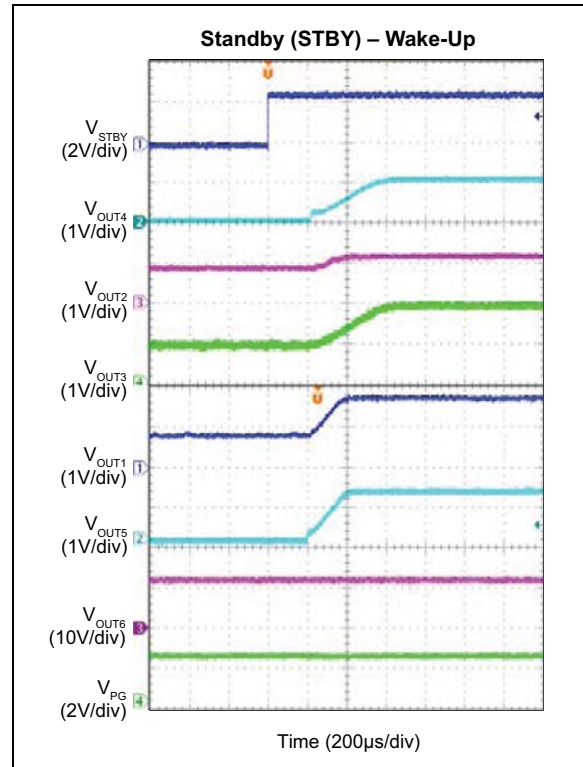


**FIGURE 4-13:** Output Pull-Down Resistance.

## 4.15 STBY Pin

A pin-selectable STBY input allows the MIC7400 to be placed into standby or normal mode. In standby mode, the individual regulator can be turned on or off or the output voltage can be set to a different value. If the regulators are turned off, standby mode cuts the quiescent current by 23 μA for each buck regulator and 70 μA for the boost.

Figure 4-14 illustrates the STBY pin operation. A low-to-high transition on the STBY pin switches the output from standby mode to normal mode. There is a 100 μs STBY de-glitch time to eliminate nuisance tripping then all the regulators are enabled at the same time and ramp up with their programmed ramp rates. A high-to-low transition on the STBY pin switches the output from normal mode to standby mode.

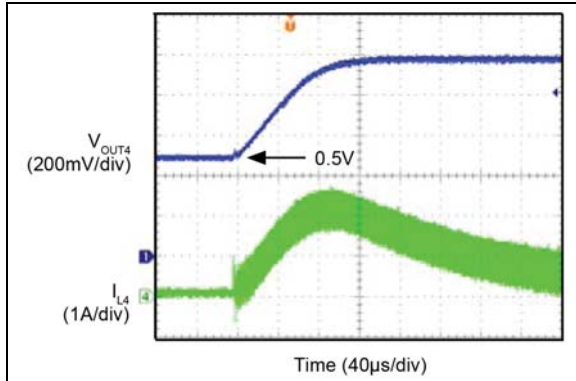


**FIGURE 4-14:** STBY-to-NORMAL Transition (DEFAULT).

## 4.16 Safe Start-Up into a Pre-Biased Output

The MIC7400 is designed for safe start-up into a pre-biased output. This prevents large negative inductor currents that can cause the output voltage to dip and excessive output voltage oscillations. A zero crossing comparator is used to detect a negative inductor current. If a negative inductor current is detected, the low-side synchronous MOSFET functions as a diode and is immediately turned off.

Figure 4-15 shows a 1V output pre-bias at 0.5V at start-up, see V\_OUT4 trace. The inductor current, trace I\_L4, is not allowed to go negative by more than 0.5A before the low-side switch is turned off. This feature prevents high negative inductor current flow in a pre-bias condition which can damage the IC.



**FIGURE 4-15:** Pre-Biased Output Voltage.

## 4.17 Buck Regulator Power Dissipation

The total power dissipation in a MIC7400 is a combination of the five buck regulators and the boost dissipation. The buck regulators (OUT1 to OUT5) dissipation is approximately the switcher's input power minus the switcher's output power and minus the power loss in the inductor:

### EQUATION 4-6:

$$P_{D\_BUCK} \approx V_{IN} \times I_{IN} - V_{OUT} \times I_{OUT} - P_{L\_LOSS}$$

While the boost power dissipation is estimated by [Equation 4-7](#):

### EQUATION 4-7:

$$P_{D\_BOOST} \approx V_{IN} \times I_{IN} - V_{OUT} \times I_{OUT} - P_{L\_LOSS} - V_f \times I_{OUT}$$

Although the maximum output current for a single buck regulator can be as much as 3A, the MIC7400 will thermal limit and will not support this high output current on all outputs at the same time.

## 4.18 Total Power Dissipation

The total power dissipation in the MIC7400 package is equal to the sum of the power loss of each regulator:

### EQUATION 4-8:

$$P_{D\_TOTAL} \approx SUM(P_{D\_SWITCHERS})$$

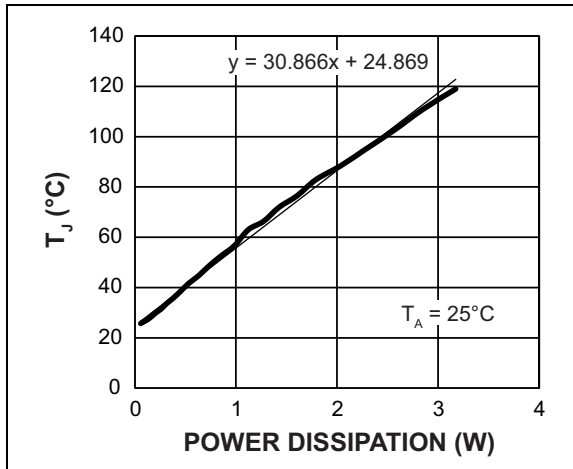
Once the total power dissipation is calculated, the IC junction temperature can be estimated using [Equation 4-9](#):

### EQUATION 4-9:

$$T_{J(MAX)} \approx T_A + P_{D\_TOTAL} \times \theta_{JA}$$

Where:  
 $T_{J(MAX)}$  = The maximum junction temperature.  
 $T_A$  = The ambient temperature.  
 $\theta_{JA}$  = The junction-to-ambient thermal resistance of the package (30°C/W).

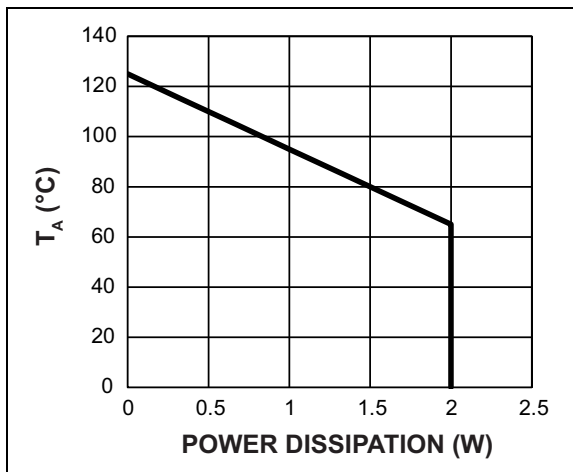
[Figure 4-16](#) shows the measured junction temperature versus power dissipation of the MIC7400 evaluation board. The actual junction temperature of the IC depends upon many factors. The significant factors influencing the die temperature rise are copper thickness in the PCB, the surface area available for convection heat transfer, air flow and power dissipation from other components, including inductors, SOCs and processor ICs. It is good engineering practice to measure all power components temperature during the final design review using a thermal couple or IR thermometer, see the [Thermal Measurements](#) sub-section for details.



**FIGURE 4-16:** Power Dissipation.

## 4.19 Power Derating

The MIC7400 package has a 2W power dissipation limit. To keep the IC junction temperature below a 125°C design limit, the output power has to be limited above an ambient temperature of 65°C. Figure 4-17 shows the power dissipation derating curve.



**FIGURE 4-17:** Power Derating Curve.

The maximum power dissipation of the package can be calculated by Equation 4-10:

### EQUATION 4-10:

$$P_{D(MAX)} \approx \frac{T_{J(MAX)} - T_A}{\theta_{JA}}$$

Where:

$T_{J(MAX)}$  = The maximum junction temperature (125°C).

$T_A$  = The ambient temperature.

$\theta_{JA}$  = The junction-to-ambient thermal resistance of the package (30°C/W).

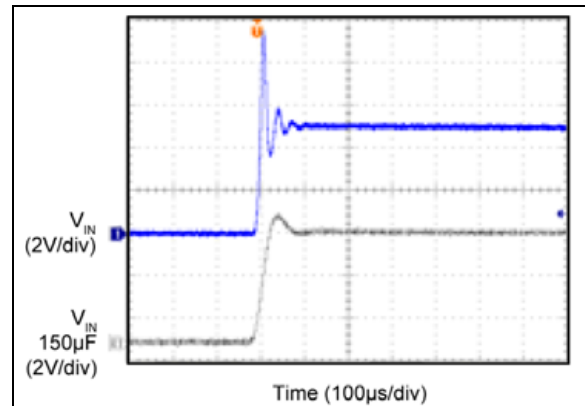
## 4.20 Overtemperature Fault

An overtemperature fault is triggered when the IC junction temperature reaches 160°C. When this occurs, both the overtemperature fault flag is set to “1”, the global power good output is pulled low and all the outputs are turned off. During the fault condition the I<sup>2</sup>C interface remains active and all registers values are maintained.

When the die temperature decreases by 20°C the overtemperature fault bit can be cleared. To clear the fault, either recycle power or write a logic “0” to the over temperature fault register. Once the fault bit is cleared, the outputs power up to their default values and are sequenced according to the time slot settings.

## 4.21 Input Voltage “Hot Plug”

High voltage spikes of twice the input voltage can appear on the MIC7400 PVIN pins if a battery pack is hot-plugged to the input supply voltage connection as shown in Figure 4-18 (Trace 1). These spikes are due to the inductance of the wires to the battery and the very low inductance and ESR of the ceramic input capacitors. This problem can be solved by placing a 150 µF POS capacitor across the input terminals. Figure 4-18 (Trace 2) shows that the high voltage spike is greatly reduced to a value below the maximum allowable input voltage rating.



**FIGURE 4-18:** Hot Plug Input Voltage Spike.

## 4.22 Thermal Measurements

Measuring the IC’s case temperature is recommended to ensure it is within its operating limits. Although this might seem like a very elementary task, it is easy to get erroneous results. The most common mistake is to use the standard thermal couple that comes with a thermal meter. This thermal couple wire gauge is large (typically 22 gauge) and behaves like a heatsink, resulting in a lower case measurement.

# MIC7400

---

Two reliable methods of temperature measurement are a smaller thermal couple wire or an infrared thermometer. If a thermal couple wire is used, it must be constructed of 36 gauge wire or higher (smaller wire size) to minimize the wire heat-sinking effect. In addition, the thermal couple tip must be covered in either thermal grease or thermal glue to make sure that the thermal couple junction is making good contact with the case of the IC. Omega brand thermal couple (5SC-TT-K-36-36) is adequate for most applications.

Whenever possible, an infrared thermometer is recommended. The measurement spot size of most infrared thermometers is too large for an accurate reading on a small form factor ICs. However, an IR thermometer from Optris has a 1 mm spot size, which makes it a good choice for measuring the hottest point on the case. An optional stand makes it easy to hold the beam on the IC for long periods of time.

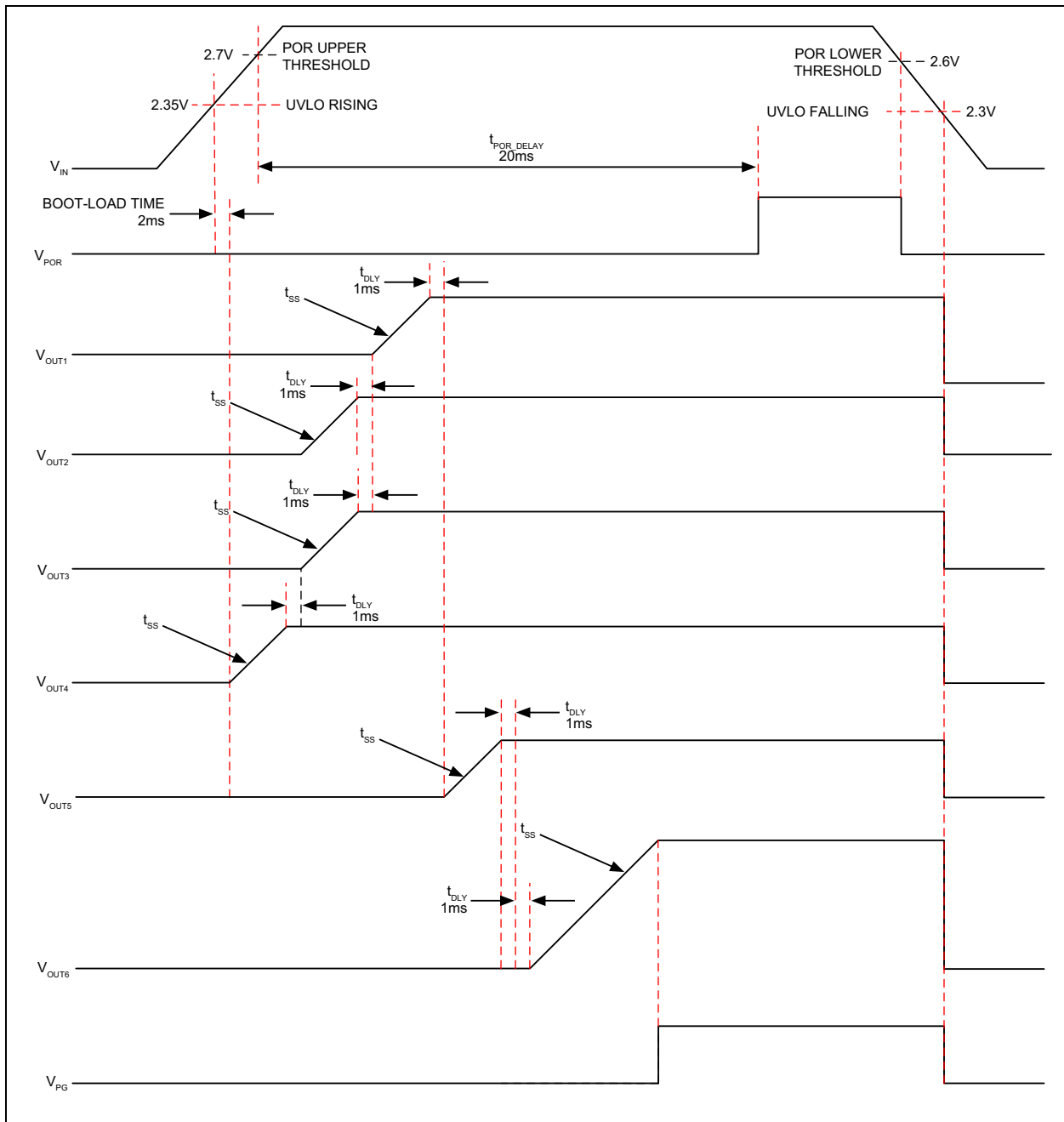


## 5.0 TIMING DIAGRAMS

### 5.1 Normal Power-Up Sequence for Outputs

The STDEL register sets the delay between powering up of each regulator at initial power-up (see power-up sequencing in [Figure 5-1](#)). Once all the internal power good registers PGOOD[1-6] are all “1”, then the global PG pin goes high without delay (see the [Global Power Good Pin](#) section for more information).

The PORDEL register sets the delay for the POR flag pin. The POR delay time starts as soon as the  $AV_{IN}$  pin voltage rises above the system UVLO upper threshold set by the PORUP register. The POR output goes low without delay if  $AV_{IN}$  falls below the lower UVLO threshold set by the PORDN register.



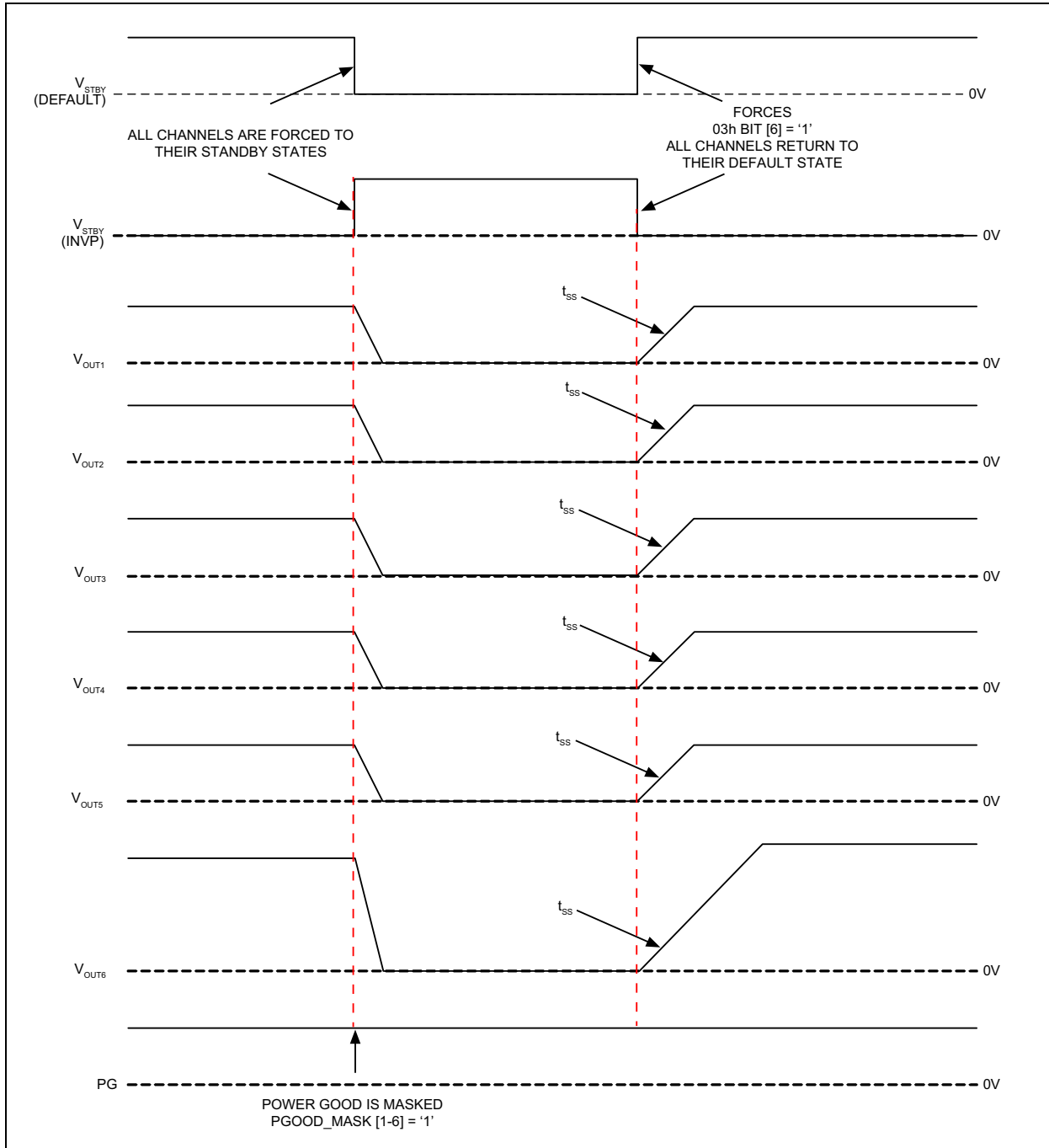
**FIGURE 5-1:** MIC7400 Power-Up/Down.

# MIC7400

## 5.2 Standby (STBY) Pin (Wake-Up)

An I<sup>2</sup>C write command to the STBY\_CTRL\_REG register or the STBY pin can be used to set the MIC7400 into standby mode. The standby (STBY) pin provides a hardware-specific manner in which to wake-up from stand-by mode and go into normal mode. Figure 5-2 shows the STBY pin operation. A low-to-high transition on the STBY pin switches the output from stand-by mode to normal mode.

There is a 100  $\mu$ s STBY deglitch time to eliminate nuisance tripping, then all the regulators are enabled at the same time and ramp up with their programmed ramp rates.



**FIGURE 5-2:** MIC7400 STBY Function (DEFAULT).



## 6.0 PCB LAYOUT GUIDELINES

PCB layout is critical to achieve reliable, stable, and efficient performance. A ground plane is required to control EMI and minimize the inductance in power, signal, and return paths.

To minimize EMI and output noise, follow these layout recommendations to ensure proper operation:

### 6.1 General

- Most of the heat removed from the IC is due to the exposed pad (EP) on the bottom of the IC conducting heat into the internal ground planes and the ground plane on the bottom side of the board. Use at least 16 vias for the EP to ground plane connection.
- Do not connect the PGND and AGND traces together on the top layer. The single point connection is made on the layer 2 ground plane.
- Do not put a via directly in front of a high current pin, SW, PGND, or PVIN. This will increase the trace resistance and parasitic inductance.
- Do not place a via in between the input and output capacitor ground connection. Put it to the inside of the output capacitor and in the way of the high di/dt current path.
- Route all power traces on the top layer.
- Place the input capacitors first and put them as close as possible to the IC.

### 6.2 IC

- The 2.2  $\mu$ F ceramic capacitor, which is connected to the AVIN pin, must be located right at the IC. The AVIN pin is very noise sensitive and placement of the capacitor is very critical. Use wide traces to connect to the AVIN and AGND pins.
- The analog ground pin (AGND) must be connected directly to the ground planes. Do not route the SGND pin to the PGND Pad on the top layer.
- Use wide traces to route the input and output power lines.
- Use Layer 5 as an input voltage power plane.
- Layer 2 and the bottom layer (Layer 6) are ground planes.

### 6.3 Input Capacitor

- A 10  $\mu$ F X5R or X7R dielectrics ceramic capacitor is recommended on each of the PVIN pins for bypassing.
- Place the input capacitors on the same side of the board and as close to the IC as possible.
- Keep both the PVIN pin and PGND connections short.

- If possible, place vias to the ground plane close to the each input capacitor ground terminal, but not in the way of the high di/dt current path.
- Use either X7R or X5R dielectric input capacitors. Do not use Y5V or Z5U type capacitors.
- Do not replace the ceramic input capacitor with any other type of capacitor. Any type of capacitor can be placed in parallel with the input capacitor.
- In “Hot-Plug” applications, a Tantalum or Electrolytic bypass capacitor must be used to limit the over-voltage spike seen on the input supply with power is suddenly applied.

### 6.4 Inductor

- Keep the inductor connection to the switch node (SW) short.
- Do not route any digital lines underneath or close to the inductor.
- To minimize noise, place a ground plane underneath the inductor.

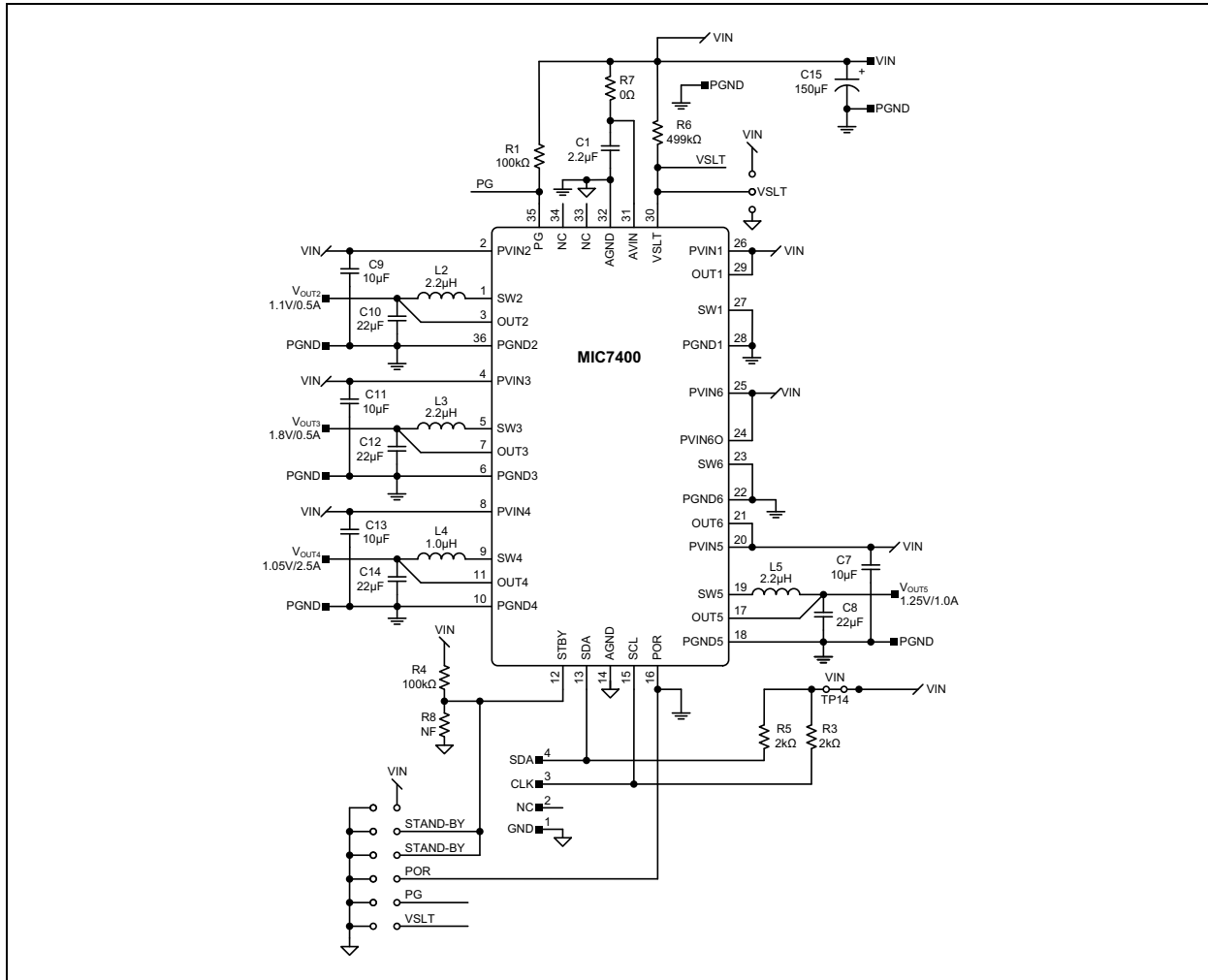
### 6.5 Output Capacitor

- Use a wide trace to connect the output capacitor ground terminal to the input capacitor ground terminal.
- The OUT[1-6] trace should be separate from the power trace and connected as close as possible to the output capacitor. Sensing a long high-current load trace can degrade the DC load regulation.

# MIC7400

## 6.6 Proper Termination of Unused Pins

Many designs will not require all six DC/DC output voltages. In these cases, the unused pin must be connected to either VIN or GND. The schematic in [Figure 6-1](#) shows where to tie the unused pins and [Table 6-1](#) summarizes the connections.



**FIGURE 6-1:** Connections for Unused Pins.

**TABLE 6-1: SUMMARIZATION OF UNUSED PIN CONNECTIONS**

| Unused | VIN                  | PGND           |
|--------|----------------------|----------------|
| Boost  | PVIN6, PGIN60, VOUT6 | PGND6, SW6     |
| Buck   | PVIN[x], VOUT[x]     | PGND[6], SW[x] |
| POR    | —                    | POR            |

## 7.0 I<sup>2</sup>C CONTROL REGISTER

The MIC7400 I<sup>2</sup>C Read/Write registers are detailed here. During normal operation, the configuration data can be saved into non-volatile registers in EEPROM by addressing the chip and writing to SAVECONFIG key = 66'h. Saving CONFIG data to EEPROM takes time so the external host should poll the MIC7400 and read the CONFIG bit[1] of EEPROM Ready register 01'h to determine the end of programming.

All transactions start with a control byte sent from the I<sup>2</sup>C master device. The control byte begins with a START condition, followed by a 7-bit slave address. The slave address is seven bits long followed by an eighth bit which is a data direction bit (R/W), a "0" indicates a transmission (WRITE) and a "1" indicates a request for data (READ). A data transfer is always terminated by a STOP condition that is generated by the master.

## 7.1 Serial Port Operation

### 7.1.1 EXTERNAL HOST INTERFACE

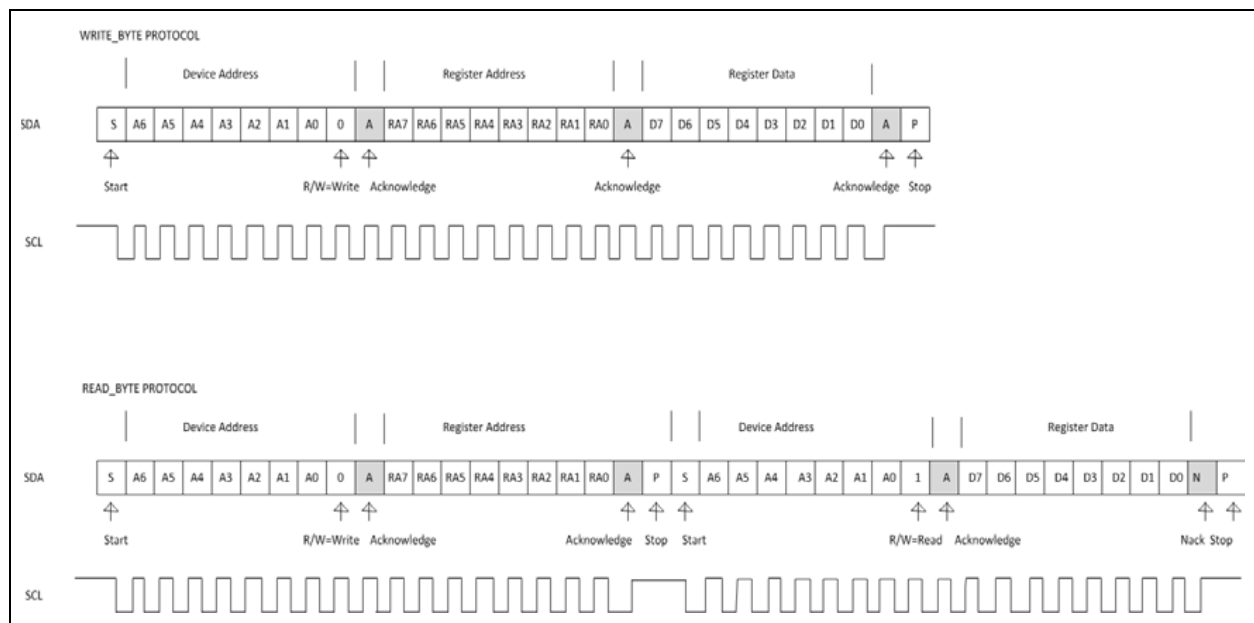
Bidirectional I<sup>2</sup>C port capable of Standard (up to 100 kbits/s), Fast (up to 400 kbits/s), Fast Plus (up to 1 Mbit/s) and High Speed (up to 3.4 Mbit/s) as defined in the I<sup>2</sup>C-Bus Specification.

The MIC7400 acts as an I<sup>2</sup>C slave when addressed by the external host. The MIC7400 slave address uses a fixed 7-bit code and is followed by an R/W bit which is part of the control word that is right after the start bit as shown in Figure 7-1 in the Device Address column.

The MIC7400 can receive multiple data bytes after a single address byte and automatically increments its register pointer to block fill internal volatile memory. Byte data is latched after individual bytes are received so multi-byte transfers could be corrupted if interrupted mid-stream.

No system clock is required by the digital core for I<sup>2</sup>C access from the external host (only the host SCL clock is assumed).

In order to prevent spurious operation of the I<sup>2</sup>C, if a start bit is seen, then any partial communication is aborted and new I<sup>2</sup>C data is allowed. Start bit is when SDA goes low when SCL is high. Stop bit is when SDA goes high when SCL is high. Normal I<sup>2</sup>C exchange is shown in Figure 7-1.



**FIGURE 7-1:** Read/Write Protocol.

# MIC7400

---

## 7.1.2 SPECIAL HOST I<sup>2</sup>C COMMANDS

The following commands are all 2 byte communications:

- Byte1 = Device address with write bit set, LSB = 0.
- Byte2 = Special key.

Special keys include the following:

- SAVECONFIG Key = 66'h. Saves the shadow register configuration data into EEPROM registers 03'h through 23'h.
- RESET Key = 6A'h. Reloads only NORMAL mode voltage and current limit settings then enables the regulator to NORMAL mode with no soft-start, no sequencing, and no delays. Then it clears the STANDBY register bit 6 in register 03'h.
- RELOAD Key = 6B'h. Reloads all data from EEPROM into the shadow registers. No other actions are performed, including soft-start, sequencing, and delay.
- REBOOT Key = 6C'h. Turns all regulators OFF, reloads EEPROM data into shadow registers, then re-sequences the regulators with the programmed soft-start and sequence delays.
- SEQUENCE Key = 6D'h. Turns all regulators OFF, restarts the sequencer including soft-start and sequence delays.

OBS: In order to use the Special Keys, FORCE\_CLK\_ON bit 2 of the Internal Clock control register (0x2F'h) must be set to "1". After the action has completed, the FORCE\_CLK\_ON bit can be cleared by writing "0".

## 8.0 REGISTER SETTINGS DESCRIPTIONS

### 8.1 Power Good Register (00'h)

This register indicates when the regulators 1 – 6 output voltage is above 91% of the target value. The MIC7400 de-glitches the input signal for 50  $\mu$ s in order to prevent false events. The global PG pin indicator is functional 'AND' of all the power good indicators during sequencing. Once the power-up sequence is complete, the global power good output stays high unless an output falls below its power-good limit, a thermal fault occurs, the input voltage drops below the lower UVLO threshold or an output is turned OFF by setting the enable register bit to "0" if the PGOOD\_MASK[x] bit is set to "0".

**TABLE 8-1: POWER GOOD STATUS REGISTER**

| Register Name | PGOOD1-6_REG |     |         | Power Good Status Register           |                 |
|---------------|--------------|-----|---------|--------------------------------------|-----------------|
| Address       | —            |     |         | 0x00'h                               |                 |
| Field         | Bit          | R/W | Default | Description                          |                 |
| PGOOD1        | 0            | R   | 0       | Power Good indicator for Regulator 1 |                 |
|               |              |     |         | 0 = Buck Not Valid                   | 1 = Buck Valid  |
| PGOOD2        | 1            | R   | 0       | Power Good indicator for Regulator 2 |                 |
|               |              |     |         | 0 = Buck Not Valid                   | 1 = Buck Valid  |
| PGOOD3        | 2            | R   | 0       | Power Good indicator for Regulator 3 |                 |
|               |              |     |         | 0 = Buck Not Valid                   | 1 = Buck Valid  |
| PGOOD4        | 3            | R   | 0       | Power Good indicator for Regulator 4 |                 |
|               |              |     |         | 0 = Buck Not Valid                   | 1 = Buck Valid  |
| PGOOD5        | 4            | R   | 0       | Power Good indicator for Regulator 5 |                 |
|               |              |     |         | 0 = Buck Not Valid                   | 1 = Buck Valid  |
| PGOOD6        | 5            | R   | 0       | Power Good indicator for Regulator 6 |                 |
|               |              |     |         | 0 = Boost Not Valid                  | 1 = Boost Valid |
| Reserved      | 6            | R/W | 0       | Not Used                             |                 |
| Reserved      | 7            | R/W | 0       | Not Used                             |                 |

### 8.2 EEPROM-Ready Register (01'h)

This register indicates the status of EEPROM to external I<sup>2</sup>C host.

The READY bit = 1 when the Trim and Configuration data have been loaded into core from EEPROM after reset, reboot or reload and the chip is ready for operation. If the SAVE1 bit in register 04'h is read in as logic 1, the configuration registers will not be loaded from the EEPROM memory and the READY bit will still get set indicating that any startup procedure involving the EEPROM memory is complete. The READY bit will be set to 1 after loading or attempting to load Trim and Configuration data from EEPROM into volatile memory. The Trim data will always be loaded and if SAVE1 bit in register 04'h is set to logic 0, Configuration data is also loaded. Regardless of the SAVE1 bit being set or not, after the loading operation the READY bit is set to 1.

The CONFIG bit = 1 when the Configuration data have been saved to EEPROM after the SAVECONFIG Code is issued from the Host. If CONFIG=1 before the SAVECONFIG code is issued, CONFIG will be cleared immediately and then will be set to logic 1 again once all Configuration data is written to the EEPROM memory.

The EEPREAD and EEPWRITE bits indicate if an EEPROM read or write fault has occurred. These bits should be read and cleared prior to reloading data from the EEPROM memory.

# MIC7400

**TABLE 8-2: EEPROM STATUS REGISTER**

| Register Name | STATUS_REG |     |         | EEPROM Status Register   |
|---------------|------------|-----|---------|--|
| Address       | —          |     |         | 0x01'h   |
| Field         | Bit        | R/W | Default | Description  |
| READY         | 0          | R   | 0       | Indicate ready for operation when the trim and configuration data has been loaded. |
|               |            |     |         | 0 = Data not loaded  |
| CONFIG        | 1          | R   | 0       | Indicate Configuration saved to EEPROM   |
|               |            |     |         | 0 = Configuration not saved  |
| Reserved      | 2          | R   | 0       | Not Used   |
| Reserved      | 3          | R/W | 0       | Not Used   |
| Reserved      | 4          | R/W | 0       | Not Used   |
| Reserved      | 5          | R/W | 0       | Not Used   |
| EEPREAD       | 6          | R/W | 0       | EEPROM Read  |
|               |            |     |         | 0 = No Fault   |
| EEPWRITE      | 7          | R/W | 0       | EEPROM Write   |
|               |            |     |         | 0 = No Fault   |

## 8.3 Fault Registers (02'h)

This register indicates the overcurrent flag for each regulator and one global overtemperature (OT). These register bits are set by an overcurrent condition and reset by writing a logic “0” to each bit by the I<sup>2</sup>C host. The respective channel must be restarted to enter normal functionality in order to successfully clear the over current fault.

If the fault condition persists, the bit will be set to logic “1” again immediately by the MIC7400 after it is written to logic “0” by the host.

**TABLE 8-3: OVERCURRENT STATUS FAULT REGISTER**

| Register Name | FAULT_REG |     |         | Overcurrent Status Fault Register |
|---------------|-----------|-----|---------|-----------------------------------|
| Address       | —         |     |         | 0x02'h                            |
| Field         | Bit       | R/W | Default | Description                       |
| REG1OC        | 0         | R/W | 0       | Regulator 1 Overcurrent           |
|               |           |     |         | 0 = No Fault                      |
| REG2OC        | 1         | R/W | 0       | Regulator 2 Overcurrent           |
|               |           |     |         | 0 = No Fault                      |
| REG3OC        | 2         | R/W | 0       | Regulator 3 Overcurrent           |
|               |           |     |         | 0 = No Fault                      |
| REG4OC        | 3         | R/W | 0       | Regulator 4 Overcurrent           |
|               |           |     |         | 0 = No Fault                      |
| REG5OC        | 4         | R/W | 0       | Regulator 5 Overcurrent           |
|               |           |     |         | 0 = No Fault                      |
| REG6OC        | 5         | R/W | 0       | Regulator 6 Overcurrent           |
|               |           |     |         | 0 = No Fault                      |
| Reserved      | 6         | R/W | 0       | Reserved                          |
| OT            | 7         | R/W | 0       | Overtemperature                   |
|               |           |     |         | 0 = No Fault                      |

## 8.4 Standby Register (03'h)

This register controls standby mode operation. Global standby mode can either be enabled by I<sup>2</sup>C or by changing the logic state of the STBY input pin. Global standby is controlled by the STBY\_MODEB bit. When STBY\_MODEB [6] = 1 then the regulators output voltages are set to their normal mode output voltage settings, (05'h – 0A'h) registers. When STBY\_MODEB [6] = 0 then regulators output voltages are set to the standby mode output voltage settings, (0B'h – 10'h) registers. If STBY [1-6] register is set to logic “0”, then the output is shut off in standby mode.

The global power good flag is asserted when an output is disabled unless the power good mask bit (PGOOD\_MASK[x]) is set to 1.

**TABLE 8-4: STANDBY REGISTER**

| Register Name | STBY_CTRL_REG |     |         | Standby Register                    |                                       |
|---------------|---------------|-----|---------|-------------------------------------|---------------------------------------|
| Address       | —             |     |         | 0x03'h                              |                                       |
| Field         | Bit           | R/W | Default | Description                         |                                       |
| STBY1         | 0             | R/W | 1       | Regulator 1 Standby Voltage Control |                                       |
|               |               |     |         | 0 = OFF                             | 1 = ON                                |
| STBY2         | 1             | R/W | 1       | Regulator 2 Standby Voltage Control |                                       |
|               |               |     |         | 0 = OFF                             | 1 = ON                                |
| STBY3         | 2             | R/W | 1       | Regulator 3 Standby Voltage Control |                                       |
|               |               |     |         | 0 = OFF                             | 1 = ON                                |
| STBY4         | 3             | R/W | 1       | Regulator 4 Standby Voltage Control |                                       |
|               |               |     |         | 0 = OFF                             | 1 = ON                                |
| STBY5         | 4             | R/W | 1       | Regulator 5 Standby Voltage Control |                                       |
|               |               |     |         | 0 = OFF                             | 1 = ON                                |
| STBY6         | 5             | R/W | 1       | Regulator 6 Standby Voltage Control |                                       |
|               |               |     |         | 0 = OFF                             | 1 = ON                                |
| STBY_MODEB    | 6             | R/W | 1       | Global Standby Control              |                                       |
|               |               |     |         | 0 = All regulators in Standby Mode  | 1 = All regulators in Normal Mode     |
| SAVE1         | 7             | R/W | 0       | Save Configuration                  |                                       |
|               |               |     |         | 0 = Configuration Saved to EEPROM   | 1 = Configuration Not Saved to EEPROM |

## 8.5 Enable/Disable Register (04'h)

This register controls the enable/disable of each DC/DC regulators. When EN(n) bit transitions from “0” to “1”, then the regulator(n) is enabled with soft-start unless the STBY\_MODEB register bit in register 03'h is set to logic “0”.

The configuration save bit “SAVE1” should be cleared by customer before saving configuration data to EEPROM. This bit is used during power up to indicate via the Status register (00'h) that configuration data has previously been stored.

**TABLE 8-5: ENABLE REGISTER**

| Register Name | EN_REG |     |         | Enable Register                |        |
|---------------|--------|-----|---------|--------------------------------|--------|
| Address       | —      |     |         | 0x04'h                         |        |
| Field         | Bit    | R/W | Default | Description                    |        |
| EN1           | 0      | R/W | 1       | Regulator 1 ON/OFF Control bit |        |
|               |        |     |         | 0 = OFF                        | 1 = ON |
| EN2           | 1      | R/W | 1       | Regulator 2 ON/OFF Control bit |        |
|               |        |     |         | 0 = OFF                        | 1 = ON |
| EN3           | 2      | R/W | 1       | Regulator 3 ON/OFF Control     |        |
|               |        |     |         | 0 = OFF                        | 1 = ON |

# MIC7400

**TABLE 8-5: ENABLE REGISTER (CONTINUED)**

| Register Name | EN_REG |     |         | Enable Register            |
|---------------|--------|-----|---------|----------------------------|
| Address       | —      |     |         | 0x04'h                     |
| Field         | Bit    | R/W | Default | Description                |
| EN4           | 3      | R/W | 1       | Regulator 4 ON/OFF Control |
|               |        |     |         | 0 = OFF                    |
| EN5           | 4      | R/W | 1       | Regulator 5 ON/OFF Control |
|               |        |     |         | 0 = OFF                    |
| EN6           | 5      | R/W | 1       | Regulator 6 ON/OFF Control |
|               |        |     |         | 0 = OFF                    |
| Reserved      | 6      | R/W | 0       | Not Used                   |
| Reserved      | 7      | R/W | 0       | Not Used                   |

## 8.6 Regulator Output Voltage Setting NORMAL Mode (05'h – 09'h)

One register for each regulator output (OUT1 – OUT5). Sets output voltage of regulator for NORMAL mode operation.

**TABLE 8-6: DVC REGISTERS FOR OUT[1 – 5]**

| Register Name | OUT1-5_REG |     |  | DVC Registers for OUT[1-5]  |                |                |                |
|---------------|------------|-----|--|---|----------------|----------------|----------------|
| Address       | —          |     |  | OUT1 = 0x05'h; OUT2 = 0x06'h; OUT3 = 0x07'h<br>OUT4 = 0x08'h; OUT5 = 0x09'h |                |                |                |
| Field         | Bit        | R/W | Default  | Description   |                |                |                |
| OUT[1-5]      | 5:0        | R/W | OUT1 = 011110 (1.8V)<br>OUT2 = 101100 (1.1V)<br>OUT3 = 011110 (1.8V)<br>OUT4 = 101101 (1.05V)<br>OUT5 = 101001 (1.25V) | Output Voltage setting of OUT[1-5]<br>DVC from 3.3V to 0.8V in –50 mV steps |                |                |                |
|               |            |     |  | 000000 = 3.30V  | 010000 = 2.50V | 100000 = 1.70V | 110000 = 0.90V |
|               |            |     |  | 000001 = 3.25V  | 010001 = 2.45V | 100001 = 1.65V | 110001 = 0.85V |
|               |            |     |  | 000010 = 3.20V  | 010010 = 2.40V | 100010 = 1.60V | 110010 = 0.80V |
|               |            |     |  | 000011 = 3.15V  | 010011 = 2.35V | 100011 = 1.55V | 110011 = 0.80V |
|               |            |     |  | 000100 = 3.10V  | 010100 = 2.30V | 100100 = 1.50V | 110100 = 0.80V |
|               |            |     |  | 000101 = 3.05V  | 010101 = 2.25V | 100101 = 1.45V | 110101 = 0.80V |
|               |            |     |  | 000110 = 3.00V  | 010110 = 2.20V | 100110 = 1.40V | 110110 = 0.80V |
|               |            |     |  | 000111 = 2.95V  | 010111 = 2.15V | 100111 = 1.35V | 110111 = 0.80V |
|               |            |     |  | 001000 = 2.90V  | 011000 = 2.10V | 101000 = 1.30V | 111000 = 0.80V |
|               |            |     |  | 001001 = 2.85V  | 011001 = 2.05V | 101001 = 1.25V | 111001 = 0.80V |
|               |            |     |  | 001010 = 2.80V  | 011010 = 2.00V | 101010 = 1.20V | 111010 = 0.80V |
|               |            |     |  | 001011 = 2.75V  | 011011 = 1.95V | 101011 = 1.15V | 111011 = 0.80V |
|               |            |     |  | 001100 = 2.70V  | 011100 = 1.90V | 101100 = 1.10V | 111100 = 0.80V |
|               |            |     |  | 001101 = 2.65V  | 011101 = 1.85V | 101101 = 1.05V | 111101 = 0.80V |
|               |            |     |  | 001110 = 2.60V  | 011110 = 1.80V | 101110 = 1.00V | 111110 = 0.80V |
|               |            |     |  | 001111 = 2.55V  | 011111 = 1.75V | 101111 = 0.95V | 111111 = 0.80V |
| —             | 6          | —   | 0  | Not Used  |                |                |                |
| —             | 7          | —   | 0  | Not Used  |                |                |                |



## 8.7 Boost Regulator Output Voltage Setting NORMAL Mode (0A'h)

Sets output voltage of the boost regulator (OUT6) in NORMAL mode operation.

**TABLE 8-7: DVC REGISTERS FOR OUT6**

| Register Name | OUT6_REG |     |                 | DVC Registers                           |                |               |               |
|---------------|----------|-----|-----------------|---|----------------|---------------|---------------|
| Address       | —        |     |                 | 0x0A'h                                  |                |               |               |
| Field         | Bit      | R/W | Default         | Description                             |                |               |               |
| OUT6          | 5:0      | R/W | 001010<br>(12V) | DVC from 14V to 7V in 200 mV decrements |                |               |               |
|               |          |     |                 | 000000 = 14.0V                          | 010000 = 10.8V | 100000 = 7.6V | 110000 = 7.0V |
|               |          |     |                 | 000001 = 13.8V                          | 010001 = 10.6V | 100001 = 7.4V | 110001 = 7.0V |
|               |          |     |                 | 000010 = 13.6V                          | 010010 = 10.4V | 100010 = 7.2V | 110010 = 7.0V |
|               |          |     |                 | 000011 = 13.4V                          | 010011 = 10.2V | 100011 = 7.0V | 110011 = 7.0V |
|               |          |     |                 | 000100 = 13.2V                          | 010100 = 10.0V | 100100 = 7.0V | 110100 = 7.0V |
|               |          |     |                 | 000101 = 13.0V                          | 010101 = 9.8V  | 100101 = 7.0V | 110101 = 7.0V |
|               |          |     |                 | 000110 = 12.8V                          | 010110 = 9.6V  | 100110 = 7.0V | 110110 = 7.0V |
|               |          |     |                 | 000111 = 12.6V                          | 010111 = 9.4V  | 100111 = 7.0V | 110111 = 7.0V |
|               |          |     |                 | 001000 = 12.4V                          | 011000 = 9.2V  | 101000 = 7.0V | 111000 = 7.0V |
|               |          |     |                 | 001001 = 12.2V                          | 011001 = 9.0V  | 101001 = 7.0V | 111001 = 7.0V |
|               |          |     |                 | 001010 = 12.0V                          | 011010 = 8.8V  | 101010 = 7.0V | 111010 = 7.0V |
|               |          |     |                 | 001011 = 11.8V                          | 011011 = 8.6V  | 101011 = 7.0V | 111011 = 7.0V |
|               |          |     |                 | 001100 = 11.6V                          | 011100 = 8.4V  | 101100 = 7.0V | 111100 = 7.0V |
|               |          |     |                 | 001101 = 11.4V                          | 011101 = 8.2V  | 101101 = 7.0V | 111101 = 7.0V |
|               |          |     |                 | 001110 = 11.2V                          | 011110 = 8.0V  | 101110 = 7.0V | 111110 = 7.0V |
|               |          |     |                 | 001111 = 11.0V                          | 011111 = 7.8V  | 101111 = 7.0V | 111111 = 7.0V |
| —             | 6        | —   | 0               | Not Used                                |                | —             |               |
| —             | 7        | —   | 0               | Not Used                                |                | —             |               |

# MIC7400

## 8.8 Regulator Voltage Setting STBY Mode (0B'h – 0F'h)

This register is used to sets the output voltage of regulators 1 – 5 in STBY mode operation.

**TABLE 8-8: STANDBY REGISTERS**

| Register Name | STBY_OUT1-5_REG |     |  | Standby DVC Registers   |                |                |                |
|---------------|-----------------|-----|--|---|----------------|----------------|----------------|
| Address       | —               |     |  | OUT1 = 0x0B'h; OUT2 = 0x0C'h; OUT3 = 0x0D'h<br>OUT4 = 0x0E'h; OUT5 = 0x0F'h |                |                |                |
| Field         | Bit             | R/W | Default  | Description   |                |                |                |
| SB_OUT [1-5]  | 5:0             | R/W | OUT1 = 011110 (1.8V)<br>OUT2 = 101100 (1.1V)<br>OUT3 = 011110 (1.8V)<br>OUT4 = 101101 (1.05V)<br>OUT5 = 101001 (1.25V) | Output Voltage setting of OUT[1-5]<br>DVC from 3.3V to 0.8V in –50 mV steps |                |                |                |
|               |                 |     |  | 000000 = 3.30V  | 010000 = 2.50V | 100000 = 1.70V | 110000 = 0.90V |
|               |                 |     |  | 000001 = 3.25V  | 010001 = 2.45V | 100001 = 1.65V | 110001 = 0.85V |
|               |                 |     |  | 000010 = 3.20V  | 010010 = 2.40V | 100010 = 1.60V | 110010 = 0.80V |
|               |                 |     |  | 000011 = 3.15V  | 010011 = 2.35V | 100011 = 1.55V | 110011 = 0.80V |
|               |                 |     |  | 000100 = 3.10V  | 010100 = 2.30V | 100100 = 1.50V | 110100 = 0.80V |
|               |                 |     |  | 000101 = 3.05V  | 010101 = 2.25V | 100101 = 1.45V | 110101 = 0.80V |
|               |                 |     |  | 000110 = 3.00V  | 010110 = 2.20V | 100110 = 1.40V | 110110 = 0.80V |
|               |                 |     |  | 000111 = 2.95V  | 010111 = 2.15V | 100111 = 1.35V | 110111 = 0.80V |
|               |                 |     |  | 001000 = 2.90V  | 011000 = 2.10V | 101000 = 1.30V | 111000 = 0.80V |
|               |                 |     |  | 001001 = 2.85V  | 011001 = 2.05V | 101001 = 1.25V | 111001 = 0.80V |
|               |                 |     |  | 001010 = 2.80V  | 011010 = 2.00V | 101010 = 1.20V | 111010 = 0.80V |
|               |                 |     |  | 001011 = 2.75V  | 011011 = 1.95V | 101011 = 1.15V | 111011 = 0.80V |
|               |                 |     |  | 001100 = 2.70V  | 011100 = 1.90V | 101100 = 1.10V | 111100 = 0.80V |
|               |                 |     |  | 001101 = 2.65V  | 011101 = 1.85V | 101101 = 1.05V | 111101 = 0.80V |
|               |                 |     |  | 001110 = 2.60V  | 011110 = 1.80V | 101110 = 1.00V | 111110 = 0.80V |
|               |                 |     |  | 001111 = 2.55V  | 011111 = 1.75V | 101111 = 0.95V | 111111 = 0.80V |
| —             | 6               | —   | 0  | Not Used  |                |                |                |
| —             | 7               | —   | 0  | Not Used  |                |                |                |

## 8.9 Boost Regulator Output Voltage Setting STBY Mode (10'h)

Sets output voltage of the boost regulator (OUT6) for STBY mode operation.

**TABLE 8-9: STANDBY DVC REGISTER FOR OUT6**

| Register Name  | STBY_OUT6_REG |               |                 | DVC Registers                           |                |               |               |
|----------------|---------------|---------------|-----------------|---|----------------|---------------|---------------|
| Address        | —             |               |                 | 0x10'h                                  |                |               |               |
| Field          | Bit           | R/W           | Default         | Description                             |                |               |               |
| SB_OUT6        | 5:0           | R/W           | 001010<br>(12V) | DVC from 14V to 7V in 200 mV decrements |                |               |               |
|                |               |               |                 | 000000 = 14.0V                          | 010000 = 10.8V | 100000 = 7.6V | 110000 = 7.0V |
|                |               |               |                 | 000001 = 13.8V                          | 010001 = 10.6V | 100001 = 7.4V | 110001 = 7.0V |
|                |               |               |                 | 000010 = 13.6V                          | 010010 = 10.4V | 100010 = 7.2V | 110010 = 7.0V |
|                |               |               |                 | 000011 = 13.4V                          | 010011 = 10.2V | 100011 = 7.0V | 110011 = 7.0V |
|                |               |               |                 | 000100 = 13.2V                          | 010100 = 10.0V | 100100 = 7.0V | 110100 = 7.0V |
|                |               |               |                 | 000101 = 13.0V                          | 010101 = 9.8V  | 100101 = 7.0V | 110101 = 7.0V |
|                |               |               |                 | 000110 = 12.8V                          | 010110 = 9.6V  | 100110 = 7.0V | 110110 = 7.0V |
|                |               |               |                 | 000111 = 12.6V                          | 010111 = 9.4V  | 100111 = 7.0V | 110111 = 7.0V |
|                |               |               |                 | 001000 = 12.4V                          | 011000 = 9.2V  | 101000 = 7.0V | 111000 = 7.0V |
|                |               |               |                 | 001001 = 12.2V                          | 011001 = 9.0V  | 101001 = 7.0V | 111001 = 7.0V |
|                |               |               |                 | 001010 = 12.0V                          | 011010 = 8.8V  | 101010 = 7.0V | 111010 = 7.0V |
|                |               |               |                 | 001011 = 11.8V                          | 011011 = 8.6V  | 101011 = 7.0V | 111011 = 7.0V |
|                |               |               |                 | 001100 = 11.6V                          | 011100 = 8.4V  | 101100 = 7.0V | 111100 = 7.0V |
|                |               |               |                 | 001101 = 11.4V                          | 011101 = 8.2V  | 101101 = 7.0V | 111101 = 7.0V |
|                |               |               |                 | 001110 = 11.2V                          | 011110 = 8.0V  | 101110 = 7.0V | 111110 = 7.0V |
| 001111 = 11.0V | 011111 = 7.8V | 101111 = 7.0V | 111111 = 7.0V   |   |                |               |               |
| —              | 6             | —             | 0               | Not Used                                |                | —             |               |
| —              | 7             | —             | 0               | Not Used                                |                | —             |               |

## 8.10 Sequence Register (11'h)

Each regulator can be assigned to start in any one of six sequencing slots (1 to 6). If starting in slot 1, the regulator starts immediately. If starting in any other slot, the regulator must wait for the PGOOD = 1 flags of all regulators assigned to the preceding slot and then wait for the specified delay time (register 17'h) i.e., all PGOODs in preceding state flag then the delay timer is started and when delay completes the regulator is enabled.

Each regulator will delay its startup (after the appropriate preceding PGOOD flags) by the delay set in the Delay Register (17'h), unless the regulator is assigned to sequence state 0.

If all default Enable bits = 0 the IC starts up, but no outputs are enabled.

Sequencing is only used during initial startup, and not used when outputs are enabled via I<sup>2</sup>C command. If outputs are enabled via I<sup>2</sup>C, then soft-start is still active, but start-up delays (timed from preceding PGOODs) are not.

**TABLE 8-10: SEQUENCE STATE 1 REGISTER**

| Register Name | SEQ1_REG |     |         | Sequence Register |  |
|---------------|----------|-----|---------|-------------------|--|
| Address       | —        |     |         | 0x11'h            |  |
| Field         | Bit      | R/W | Default | Description       |  |
| REG1SQ1       | 0        | R/W | 0       | 0 = No Start      | 1 = Regulator 1 will Start in Sequence State 1 |
| REG2SQ1       | 1        | R/W | 0       | 0 = No Start      | 1 = Regulator 2 will Start in Sequence State 1 |
| REG3SQ1       | 2        | R/W | 0       | 0 = No Start      | 1 = Regulator 3 will Start in Sequence State 1 |

# MIC7400

**TABLE 8-10: SEQUENCE STATE 1 REGISTER (CONTINUED)**

| Register Name | SEQ1_REG |     |         | Sequence Register |  |
|---------------|----------|-----|---------|-------------------|--|
| Address       | —        |     |         | 0x11'h            |  |
| Field         | Bit      | R/W | Default | Description       |  |
| REG4SQ1       | 3        | R/W | 1       | 0 = No Start      | 1 = Regulator 4 will Start in Sequence State 1 |
| REG5SQ1       | 4        | R/W | 0       | 0 = No Start      | 1 = Regulator 5 will Start in Sequence State 1 |
| REG6SQ1       | 5        | R/W | 0       | 0 = No Start      | 1 = Regulator 6 will Start in Sequence State 1 |
| —             | 6        | R/W | 0       | Reserved          |  |
| —             | 7        | R/W | 0       | Reserved          |  |

**TABLE 8-11: SEQUENCE STATE 2 REGISTER**

| Register Name | SEQ2_REG |     |         | Sequence Register |  |
|---------------|----------|-----|---------|-------------------|--|
| Address       | —        |     |         | 0x12'h            |  |
| Field         | Bit      | R/W | Default | Description       |  |
| REG1SQ2       | 0        | R/W | 0       | 0 = No Start      | 1 = Regulator 1 will Start in Sequence State 2 |
| REG2SQ2       | 1        | R/W | 1       | 0 = No Start      | 1 = Regulator 2 will Start in Sequence State 2 |
| REG3SQ2       | 2        | R/W | 1       | 0 = No Start      | 1 = Regulator 3 will Start in Sequence State 2 |
| REG4SQ2       | 3        | R/W | 0       | 0 = No Start      | 1 = Regulator 4 will Start in Sequence State 2 |
| REG5SQ2       | 4        | R/W | 0       | 0 = No Start      | 1 = Regulator 5 will Start in Sequence State 2 |
| REG6SQ2       | 5        | R/W | 0       | 0 = No Start      | 1 = Regulator 6 will Start in Sequence State 2 |
| —             | 6        | R/W | 0       | Reserved          |  |
| —             | 7        | R/W | 0       | Reserved          |  |

**TABLE 8-12: SEQUENCE STATE 3 REGISTER**

| Register Name | SEQ3_REG |     |         | Sequence Register |  |
|---------------|----------|-----|---------|-------------------|--|
| Address       | —        |     |         | 0x13'h            |  |
| Field         | Bit      | R/W | Default | Description       |  |
| REG1SQ3       | 0        | R/W | 1       | 0 = No Start      | 1 = Regulator 1 will Start in Sequence State 3 |
| REG2SQ3       | 1        | R/W | 0       | 0 = No Start      | 1 = Regulator 2 will Start in Sequence State 3 |
| REG3SQ3       | 2        | R/W | 0       | 0 = No Start      | 1 = Regulator 3 will Start in Sequence State 3 |
| REG4SQ3       | 3        | R/W | 0       | 0 = No Start      | 1 = Regulator 4 will Start in Sequence State 3 |
| REG5SQ3       | 4        | R/W | 0       | 0 = No Start      | 1 = Regulator 5 will Start in Sequence State 3 |
| REG6SQ3       | 5        | R/W | 0       | 0 = No Start      | 1 = Regulator 6 will Start in Sequence State 3 |

**TABLE 8-12: SEQUENCE STATE 3 REGISTER (CONTINUED)**

| Register Name | SEQ3_REG |     |         | Sequence Register |
|---------------|----------|-----|---------|-------------------|
| Address       | —        |     |         | 0x13'h            |
| Field         | Bit      | R/W | Default | Description       |
| —             | 6        | R/W | 0       | Reserved          |
| —             | 7        | R/W | 0       | Reserved          |

**TABLE 8-13: SEQUENCE STATE 4 REGISTER**

| Register Name | SEQ4_REG |     |         | Sequence Register  |
|---------------|----------|-----|---------|--|
| Address       | —        |     |         | 0x14'h   |
| Field         | Bit      | R/W | Default | Description  |
| REG1SQ4       | 0        | R/W | 0       | 0 = No Start<br>1 = Regulator 1 will Start in Sequence State 4 |
| REG2SQ4       | 1        | R/W | 0       | 0 = No Start<br>1 = Regulator 2 will Start in Sequence State 4 |
| REG3SQ4       | 2        | R/W | 0       | 0 = No Start<br>1 = Regulator 3 will Start in Sequence State 4 |
| REG4SQ4       | 3        | R/W | 0       | 0 = No Start<br>1 = Regulator 4 will Start in Sequence State 4 |
| REG5SQ4       | 4        | R/W | 1       | 0 = No Start<br>1 = Regulator 5 will Start in Sequence State 4 |
| REG6SQ4       | 5        | R/W | 0       | 0 = No Start<br>1 = Regulator 6 will Start in Sequence State 4 |
| —             | 6        | R/W | 0       | Reserved   |
| —             | 7        | R/W | 0       | Reserved   |

**TABLE 8-14: SEQUENCE STATE 5 REGISTER**

| Register Name | SEQ5_REG |     |         | Sequence Register  |
|---------------|----------|-----|---------|--|
| Address       | —        |     |         | 0x15'h   |
| Field         | Bit      | R/W | Default | Description  |
| REG1SQ5       | 0        | R/W | 0       | 0 = No Start<br>1 = Regulator 1 will Start in Sequence State 5 |
| REG2SQ5       | 1        | R/W | 0       | 0 = No Start<br>1 = Regulator 2 will Start in Sequence State 5 |
| REG3SQ5       | 2        | R/W | 0       | 0 = No Start<br>1 = Regulator 3 will Start in Sequence State 5 |
| REG4SQ5       | 3        | R/W | 0       | 0 = No Start<br>1 = Regulator 4 will Start in Sequence State 5 |
| REG5SQ5       | 4        | R/W | 0       | 0 = No Start<br>1 = Regulator 5 will Start in Sequence State 5 |
| REG6SQ5       | 5        | R/W | 0       | 0 = No Start<br>1 = Regulator 6 will Start in Sequence State 5 |
| —             | 6        | R/W | 0       | Reserved   |
| —             | 7        | R/W | 0       | Reserved   |

**TABLE 8-15: SEQUENCE STATE 6 REGISTER**

| Register Name | SEQ6_REG |     |         | Sequence Register |  |
|---------------|----------|-----|---------|-------------------|--|
| Address       | —        |     |         | 0x16'h            |  |
| Field         | Bit      | R/W | Default | Description       |  |
| REG1SQ6       | 0        | R/W | 0       | 0 = No Start      | 1 = Regulator 1 will Start in Sequence State 6 |
| REG2SQ6       | 1        | R/W | 0       | 0 = No Start      | 1 = Regulator 2 will Start in Sequence State 6 |
| REG3SQ6       | 2        | R/W | 0       | 0 = No Start      | 1 = Regulator 3 will Start in Sequence State 6 |
| REG4SQ6       | 3        | R/W | 0       | 0 = No Start      | 1 = Regulator 4 will Start in Sequence State 6 |
| REG5SQ6       | 4        | R/W | 0       | 0 = No Start      | 1 = Regulator 5 will Start in Sequence State 6 |
| REG6SQ6       | 5        | R/W | 1       | 0 = No Start      | 1 = Regulator 6 will Start in Sequence State 6 |
| —             | 6        | R/W | 0       | Reserved          |  |
| —             | 7        | R/W | 0       | Reserved          |  |

## 8.11 Delay Register (17'h)

The STDEL register sets the delay between powering up of each regulator at initial power up (see [Figure 5-1](#)). Once all the internal power good registers PGOOD[1-6] are all “1”, then the global PG pin goes high without delay.

The PORDEL register sets the delay for the POR flag pin. The POR delay time starts as soon as AVIN pin voltage rises above the system UVLO upper threshold set by the PORUP register (21'h). The POR output goes low without delay if AVIN falls below the lower UVLO threshold set by the PORDN register (22'h).

**TABLE 8-16: DELAY REGISTER**

| Register Name | DELAY_CNTL_REG |               |                  | Delay Register                                   |              |               |               |
|---------------|----------------|---------------|------------------|--|--------------|---------------|---------------|
| Address       | —              |               |                  | 0x17'h   |              |               |               |
| Field         | Bit            | R/W           | Default          | Description                                      |              |               |               |
| STDEL         | 2:0            | R/W           | 001<br>(1 ms)    | Delay Time from 0 ms to 7 ms in 1 ms increment   |              |               |               |
|               |                |               |                  | 000 = 0 ms                                       | 010 = 2 ms   | 100 = 4 ms    | 110 = 6 ms    |
|               |                |               |                  | 001 = 1 ms                                       | 011 = 3 ms   | 101 = 5 ms    | 111 = 7 ms    |
| PORDEL        | 7:3            | R/W           | 00011<br>(20 ms) | Delay Time from 5 ms to 160 ms in 5 ms increment |              |               |               |
|               |                |               |                  | 00000 = 5ms                                      | 01000 = 45ms | 10000 = 85ms  | 11000 = 125ms |
|               |                |               |                  | 00001 = 10ms                                     | 01001 = 50ms | 10001 = 90ms  | 11001 = 130ms |
|               |                |               |                  | 00010 = 15ms                                     | 01010 = 55ms | 10010 = 95ms  | 11010 = 135ms |
|               |                |               |                  | 00011 = 20ms                                     | 01011 = 60ms | 10011 = 100ms | 11011 = 140ms |
|               |                |               |                  | 00100 = 25ms                                     | 01100 = 65ms | 10100 = 105ms | 11100 = 145ms |
|               |                |               |                  | 00101 = 30ms                                     | 01101 = 70ms | 10101 = 110ms | 11101 = 150ms |
|               |                |               |                  | 00110 = 35ms                                     | 01110 = 75ms | 10110 = 115ms | 11110 = 155ms |
| 00111 = 40ms  | 01111 = 80ms   | 10111 = 120ms | 11111 = 160ms    |  |              |               |               |

## 8.12 Soft-Start Registers (18'h – 1A'h)

When regulator(n) is turned on from either the Enable Register (04'h) in NORMAL mode or from the Standby Register (03'h) in STANDBY mode, the three REG(n)SS soft-start bits are used to control both the rising and falling ramp rate of the outputs.

In NORMAL mode, the outputs are stepped from the current regulator voltage settings to a newly programmed regulator voltage setting or to the default value.

On power-up, the regulator voltage output is set to the lowest possible voltage setting, which is 3F'h. The voltage regulator will change by one step or increment at a time. The amount of time between each step is controlled by the soft-start registers. Table 8-17 details the amount of time for each encoded soft-start value.

**TABLE 8-17: SOFT-START REGISTER SPEED SETTINGS**

| Register     | R/W | Default | Description                                    |                  |                   |                    |
|--------------|-----|---------|--|------------------|-------------------|--------------------|
| SS_SPEED = 0 | R/W | 000     | Soft-Start Time from 4 $\mu$ s to 512 $\mu$ s  |                  |                   |                    |
|              |     |         | 000 = 4 $\mu$ s                                | 010 = 16 $\mu$ s | 100 = 64 $\mu$ s  | 110 = 256 $\mu$ s  |
|              |     |         | 001 = 8 $\mu$ s                                | 011 = 32 $\mu$ s | 101 = 128 $\mu$ s | 111 = 512 $\mu$ s  |
| SS_SPEED = 1 | R/W | 000     | Soft-Start Time from 8 $\mu$ s to 1024 $\mu$ s |                  |                   |                    |
|              |     |         | 000 = 8 $\mu$ s                                | 010 = 32 $\mu$ s | 100 = 128 $\mu$ s | 110 = 512 $\mu$ s  |
|              |     |         | 001 = 16 $\mu$ s                               | 011 = 64 $\mu$ s | 101 = 256 $\mu$ s | 111 = 1024 $\mu$ s |

**TABLE 8-18: SOFT-START REGISTER OUT1 AND OUT2**

| Register Name | SS1-2_REG |     |                    | Soft-Start Register for V <sub>OUT1</sub> and V <sub>OUT2</sub>  |
|---------------|-----------|-----|--------------------|--|
| Address       | —         |     |                    | 0x18'h   |
| Field         | Bit       | R/W | Default            | Description  |
| REG1SS        | 2:0       | R/W | 001<br>(8 $\mu$ s) | OUT1 Soft-Start Time. See <a href="#">Table 8-17</a> for Soft-Start settings.  |
| REG2SS        | 5:3       | R/W | 001<br>(8 $\mu$ s) | OUT2 Soft-Start Time. See <a href="#">Table 8-17</a> for Soft-Start settings.  |
| —             | 6         | R/W | 0                  | Reserved   |
| SS_SPEED      | 7         | R/W | 0                  | Sets the speed of the clock to slow or fast for different clock division, see <a href="#">Table 8-17</a> . 0 = Slow speed; 1 = Fast speed. |

**TABLE 8-19: SOFT-START REGISTER OUT3 AND OUT4**

| Register Name | SS3-4_REG |     |                    | Soft-Start Register for V <sub>OUT3</sub> and V <sub>OUT4</sub>               |
|---------------|-----------|-----|--------------------|---|
| Address       | —         |     |                    | 0x19'h  |
| Field         | Bit       | R/W | Default            | Description   |
| REG3SS        | 2:0       | R/W | 001<br>(8 $\mu$ s) | OUT3 Soft-Start Time. See <a href="#">Table 8-17</a> for Soft-Start settings. |
| REG4SS        | 5:3       | R/W | 001<br>(8 $\mu$ s) | OUT4 Soft-Start Time. See <a href="#">Table 8-17</a> for Soft-Start settings. |
| —             | 6         | R/W | 0                  | Reserved  |
| —             | 7         | R/W | 0                  | Reserved  |

# MIC7400

**TABLE 8-20: SOFT-START REGISTER OUT5 AND OUT6**

| Register Name | SS5-6_REG |     |                | Soft-Start Register for V <sub>OUT5</sub> and V <sub>OUT6</sub>               |
|---------------|-----------|-----|----------------|---|
| Address       | —         |     |                | 0x1A'h  |
| Field         | Bit       | R/W | Default        | Description   |
| REG5SS        | 2:0       | R/W | 001<br>(8 μs)  | OUT5 Soft-Start Time. See <a href="#">Table 8-17</a> for Soft-Start settings. |
| REG6SS        | 5:3       | R/W | 010<br>(16 μs) | OUT6 Soft-Start Time. See <a href="#">Table 8-17</a> for Soft-Start settings. |
| —             | 6         | R/W | 0              | Reserved  |
| —             | 7         | R/W | 0              | Reserved  |

## 8.13 Current-Limit (Normal Mode) Registers (1B'h – 1D'h)

This register is used to set the current limit for each DC/DC regulator in normal mode operation.

**TABLE 8-21: CURRENT-LIMIT REGISTER I<sub>OUT1</sub> AND I<sub>OUT2</sub>**

| Register Name | ILIMIT_1-2_REG |     |                | Current-Limit Register for V <sub>OUT1</sub> and V <sub>OUT2</sub>        |
|---------------|----------------|-----|----------------|---|
| Address       | —              |     |                | 0x1B'h  |
| Field         | Bit            | R/W | Default        | Description   |
| REG1CL        | 3:0            | R/W | 1001<br>(4.1A) | Normal current-limit for regulator 1 from 8.6A to 1.1A in 0.5A decrements |
|               |                |     |                | 0000 = 8.6A    0100 = 6.6A    1000 = 4.6A    1100 = 2.6 A                 |
|               |                |     |                | 0001 = 8.1A    0101 = 6.1A    1001 = 4.1A    1101 = 2.1A                  |
|               |                |     |                | 0010 = 7.6A    0110 = 5.6A    1010 = 3.6A    1110 = 1.6A                  |
| REG2CL        | 7:4            | R/W | 1001<br>(4.1A) | Normal current-limit for regulator 2 from 8.6A to 1.1A in 0.5A decrements |
|               |                |     |                | 0000 = 8.6A    0100 = 6.6A    1000 = 4.6A    1100 = 2.6 A                 |
|               |                |     |                | 0001 = 8.1A    0101 = 6.1A    1001 = 4.1A    1101 = 2.1A                  |
|               |                |     |                | 0010 = 7.6A    0110 = 5.6A    1010 = 3.6A    1110 = 1.6A                  |
| REG3CL        | 3:0            | R/W | 1001<br>(4.1A) | Normal current-limit for regulator 3 from 8.6A to 1.1A in 0.5A decrements |
|               |                |     |                | 0000 = 8.6A    0100 = 6.6A    1000 = 4.6A    1100 = 2.6 A                 |
|               |                |     |                | 0001 = 8.1A    0101 = 6.1A    1001 = 4.1A    1101 = 2.1A                  |
|               |                |     |                | 0010 = 7.6A    0110 = 5.6A    1010 = 3.6A    1110 = 1.6A                  |
| REG4CL        | 7:4            | R/W | 0101<br>(6.1A) | Normal current-limit for regulator 4 from 8.6A to 1.1A in 0.5A decrements |
|               |                |     |                | 0000 = 8.6A    0100 = 6.6A    1000 = 4.6A    1100 = 2.6 A                 |
|               |                |     |                | 0001 = 8.1A    0101 = 6.1A    1001 = 4.1A    1101 = 2.1A                  |
|               |                |     |                | 0010 = 7.6A    0110 = 5.6A    1010 = 3.6A    1110 = 1.6A                  |
| REG5CL        | 3:0            | R/W | 0101<br>(6.1A) | Normal current-limit for regulator 5 from 8.6A to 1.1A in 0.5A decrements |
|               |                |     |                | 0000 = 8.6A    0100 = 6.6A    1000 = 4.6A    1100 = 2.6 A                 |
|               |                |     |                | 0001 = 8.1A    0101 = 6.1A    1001 = 4.1A    1101 = 2.1A                  |
|               |                |     |                | 0010 = 7.6A    0110 = 5.6A    1010 = 3.6A    1110 = 1.6A                  |

**TABLE 8-22: CURRENT-LIMIT REGISTER I<sub>OUT3</sub> AND I<sub>OUT4</sub>**

| Register Name | ILIMIT_3-4_REG |     |                | Current-Limit Register for V <sub>OUT3</sub> and V <sub>OUT4</sub>        |
|---------------|----------------|-----|----------------|---|
| Address       | —              |     |                | 0x1C'h  |
| Field         | Bit            | R/W | Default        | Description   |
| REG3CL        | 3:0            | R/W | 1001<br>(4.1A) | Normal current-limit for regulator 3 from 8.6A to 1.1A in 0.5A decrements |
|               |                |     |                | 0000 = 8.6A    0100 = 6.6A    1000 = 4.6A    1100 = 2.6 A                 |
|               |                |     |                | 0001 = 8.1A    0101 = 6.1A    1001 = 4.1A    1101 = 2.1A                  |
|               |                |     |                | 0010 = 7.6A    0110 = 5.6A    1010 = 3.6A    1110 = 1.6A                  |
| REG4CL        | 7:4            | R/W | 0101<br>(6.1A) | Normal current-limit for regulator 4 from 8.6A to 1.1A in 0.5A decrements |
|               |                |     |                | 0000 = 8.6A    0100 = 6.6A    1000 = 4.6A    1100 = 2.6 A                 |
|               |                |     |                | 0001 = 8.1A    0101 = 6.1A    1001 = 4.1A    1101 = 2.1A                  |
|               |                |     |                | 0010 = 7.6A    0110 = 5.6A    1010 = 3.6A    1110 = 1.6A                  |
| REG5CL        | 3:0            | R/W | 0101<br>(6.1A) | Normal current-limit for regulator 5 from 8.6A to 1.1A in 0.5A decrements |
|               |                |     |                | 0000 = 8.6A    0100 = 6.6A    1000 = 4.6A    1100 = 2.6 A                 |
|               |                |     |                | 0001 = 8.1A    0101 = 6.1A    1001 = 4.1A    1101 = 2.1A                  |
|               |                |     |                | 0010 = 7.6A    0110 = 5.6A    1010 = 3.6A    1110 = 1.6A                  |



**TABLE 8-23: CURRENT-LIMIT REGISTER I<sub>OUT5</sub> AND I<sub>OUT6</sub>**

| Register Name | ILIMIT_5-6_REG |     |                | Current-Limit Register for V <sub>OUT5</sub> and V <sub>OUT6</sub>        |             |                       |              |
|---------------|----------------|-----|----------------|---|-------------|-----------------------|--------------|
| Address       | —              |     |                | 0x1D'h  |             |                       |              |
| Field         | Bit            | R/W | Default        | Description   |             |                       |              |
| REG5CL        | 3:0            | R/W | 1001<br>(4.1A) | Normal current-limit for regulator 5 from 8.6A to 1.1A in 0.5A decrements |             |                       |              |
|               |                |     |                | 0000 = 8.6A   | 0100 = 6.6A | 1000 = 4.6A           | 1100 = 2.6 A |
|               |                |     |                | 0001 = 8.1A   | 0101 = 6.1A | 1001 = 4.1A           | 1101 = 2.1A  |
|               |                |     |                | 0010 = 7.6A   | 0110 = 5.6A | 1010 = 3.6A           | 1110 = 1.6A  |
| REG6CL        | 6:4            | R/W | 011<br>(2.24A) | Current-limit from 2.6A to 1.78A in 0.12A decrements                      |             |                       |              |
|               |                |     |                | 000 = 2.6A  | 010 = 2.36A | 100 = 2.12A           | 110 = 1.88A  |
|               |                |     |                | 001 = 2.48A   | 011 = 2.24A | 101 = 2.00A           | 111 = 1.76A  |
| —             | 7              | R/W | 0              | 0 = Current-Limit On  |             | 1 = Current-Limit Off |              |

## 8.14 Current-Limit (STBY Mode) Registers (1E'h – 20'h)

This register is used to set the current-limit for each DC/DC regulator when in standby (STBY) mode operation.

**TABLE 8-24: STANDBY CURRENT-LIMIT REGISTER I<sub>OUT1</sub> AND I<sub>OUT2</sub>**

| Register Name | STBY_ILIMIT_1-2_REG |     |                | Standby Current-Limit Register for V <sub>OUT1</sub> and V <sub>OUT2</sub> |             |             |              |
|---------------|---------------------|-----|----------------|--|-------------|-------------|--------------|
| Address       | —                   |     |                | 0x1E'h   |             |             |              |
| Field         | Bit                 | R/W | Default        | Description  |             |             |              |
| SB1CL         | 3:0                 | R/W | 1001<br>(4.1A) | Standby current-limit for regulator 1 from 8.6A to 1.1A in 0.5A decrements |             |             |              |
|               |                     |     |                | 0000 = 8.6A  | 0100 = 6.6A | 1000 = 4.6A | 1100 = 2.6 A |
|               |                     |     |                | 0001 = 8.1A  | 0101 = 6.1A | 1001 = 4.1A | 1101 = 2.1A  |
|               |                     |     |                | 0010 = 7.6A  | 0110 = 5.6A | 1010 = 3.6A | 1110 = 1.6A  |
| SB2CL         | 7:4                 | R/W | 1001<br>(4.1A) | Standby current-limit for regulator 2 from 8.6A to 1.1A in 0.5A decrements |             |             |              |
|               |                     |     |                | 0000 = 8.6A  | 0100 = 6.6A | 1000 = 4.6A | 1100 = 2.6 A |
|               |                     |     |                | 0001 = 8.1A  | 0101 = 6.1A | 1001 = 4.1A | 1101 = 2.1A  |
|               |                     |     |                | 0010 = 7.6A  | 0110 = 5.6A | 1010 = 3.6A | 1110 = 1.6A  |
|               |                     |     |                | 0011 = 7.1A  | 0111 = 5.1A | 1011 = 3.1A | 1111 = 1.1A  |

**TABLE 8-25: STANDBY CURRENT-LIMIT REGISTER I<sub>OUT3</sub> AND I<sub>OUT4</sub>**

| Register Name | STBY_ILIMIT_3-4_REG |     |                | Standby Current-Limit Register for V <sub>OUT3</sub> and V <sub>OUT4</sub> |             |             |              |
|---------------|---------------------|-----|----------------|--|-------------|-------------|--------------|
| Address       | —                   |     |                | 0x1F'h   |             |             |              |
| Field         | Bit                 | R/W | Default        | Description  |             |             |              |
| SB3CL         | 3:0                 | R/W | 1001<br>(4.1A) | Standby current-limit for regulator 3 from 8.6A to 1.1A in 0.5A decrements |             |             |              |
|               |                     |     |                | 0000 = 8.6A  | 0100 = 6.6A | 1000 = 4.6A | 1100 = 2.6 A |
|               |                     |     |                | 0001 = 8.1A  | 0101 = 6.1A | 1001 = 4.1A | 1101 = 2.1A  |
|               |                     |     |                | 0010 = 7.6A  | 0110 = 5.6A | 1010 = 3.6A | 1110 = 1.6A  |
|               |                     |     |                | 0011 = 7.1A  | 0111 = 5.1A | 1011 = 3.1A | 1111 = 1.1A  |

# MIC7400

**TABLE 8-25: STANDBY CURRENT-LIMIT REGISTER I<sub>OUT3</sub> AND I<sub>OUT4</sub> (CONTINUED)**

| Register Name | STBY_ILIMIT_3-4_REG |     |                | Standby Current-Limit Register for V <sub>OUT3</sub> and V <sub>OUT4</sub> |             |             |              |
|---------------|---------------------|-----|----------------|--|-------------|-------------|--------------|
| Address       | —                   |     |                | 0x1F'h   |             |             |              |
| Field         | Bit                 | R/W | Default        | Description  |             |             |              |
| SB4CL         | 7:4                 | R/W | 0101<br>(6.1A) | Standby current-limit for regulator 4 from 8.6A to 1.1A in 0.5A decrements |             |             |              |
|               |                     |     |                | 0000 = 8.6A  | 0100 = 6.6A | 1000 = 4.6A | 1100 = 2.6 A |
|               |                     |     |                | 0001 = 8.1A  | 0101 = 6.1A | 1001 = 4.1A | 1101 = 2.1A  |
|               |                     |     |                | 0010 = 7.6A  | 0110 = 5.6A | 1010 = 3.6A | 1110 = 1.6A  |
|               |                     |     |                | 0011 = 7.1A  | 0111 = 5.1A | 1011 = 3.1A | 1111 = 1.1A  |

**TABLE 8-26: STANDBY CURRENT-LIMIT REGISTER I<sub>OUT5</sub> AND I<sub>OUT6</sub>**

| Register Name | STBY_ILIMIT_5-6_REG |     |                | Standby Current-Limit Register for V <sub>OUT5</sub> and V <sub>OUT6</sub> |             |                       |              |
|---------------|---------------------|-----|----------------|--|-------------|-----------------------|--------------|
| Address       | —                   |     |                | 0x20'h   |             |                       |              |
| Field         | Bit                 | R/W | Default        | Description  |             |                       |              |
| SB5CL         | 3:0                 | R/W | 1001<br>(4.1A) | Standby current-limit for regulator 5 from 8.6A to 1.1A in 0.5A decrements |             |                       |              |
|               |                     |     |                | 0000 = 8.6A  | 0100 = 6.6A | 1000 = 4.6A           | 1100 = 2.6 A |
|               |                     |     |                | 0001 = 8.1A  | 0101 = 6.1A | 1001 = 4.1A           | 1101 = 2.1A  |
|               |                     |     |                | 0010 = 7.6A  | 0110 = 5.6A | 1010 = 3.6A           | 1110 = 1.6A  |
|               |                     |     |                | 0011 = 7.1A  | 0111 = 5.1A | 1011 = 3.1A           | 1111 = 1.1A  |
| SB6CL         | 6:4                 | R/W | 011<br>(2.24A) | Current-limit from 2.6A to 1.78A in 0.12A decrements                       |             |                       |              |
|               |                     |     |                | 000 = 2.6A   | 010 = 2.36A | 100 = 2.12A           | 110 = 1.88A  |
|               |                     |     |                | 001 = 2.48A  | 011 = 2.24A | 101 = 2.00A           | 111 = 1.76A  |
| —             | 7                   | R/W | 0              | 0 = Current-Limit On   |             | 1 = Current-Limit Off |              |

## 8.15 Power-on-Reset (POR) Threshold Voltage Setting Register (21'h and 22'h)

This register is used to set the rising and falling threshold of power-on-reset (POR) comparator. The POR threshold voltage setting is based on the logic level of the VSLT pin in addition to the register bits. Refer to [Table 8-16](#) for POR time delay settings.

**TABLE 8-27: RISING AND FALLING POWER-ON-RESET THRESHOLD VOLTAGE SETTINGS**

| Condition | —   |     |         | Rising and Falling Power-On-Reset Threshold Voltage Setting |               |               |               |
|-----------|-----|-----|---------|---|---------------|---------------|---------------|
| Pin       | Bit | R/W | Default | Description   |               |               |               |
| VSCLT = 0 | 4:0 | R/W | 00000   | 3.3V to 2.3V in 50 mV decrements                            |               |               |               |
|           |     |     |         | 00000 = 3.25V   | 01000 = 2.85V | 10000 = 2.45V | 11000 = 2.25V |
|           |     |     |         | 00001 = 3.20V   | 01001 = 2.80V | 10001 = 2.40V | 11001 = 2.25V |
|           |     |     |         | 00010 = 3.15V   | 01010 = 2.75V | 10010 = 2.35V | 11010 = 2.25V |
|           |     |     |         | 00011 = 3.10V   | 01011 = 2.70V | 10011 = 2.30V | 11011 = 2.25V |
|           |     |     |         | 00100 = 3.05V   | 01100 = 2.65V | 10100 = 2.25V | 11100 = 2.25V |
|           |     |     |         | 00101 = 3.00V   | 01101 = 2.60V | 10101 = 2.25V | 11101 = 2.25V |
|           |     |     |         | 00110 = 2.95V   | 01110 = 2.55V | 10110 = 2.25V | 11110 = 2.25V |
|           |     |     |         | 00111 = 2.90V   | 01111 = 2.50V | 10111 = 2.25V | 11111 = 2.25V |

**TABLE 8-27: RISING AND FALLING POWER-ON-RESET THRESHOLD VOLTAGE SETTINGS**

| Condition | —   |     |         | Rising and Falling Power-On-Reset Threshold Voltage Setting |               |               |               |
|-----------|-----|-----|---------|---|---------------|---------------|---------------|
| Pin       | Bit | R/W | Default | Description   |               |               |               |
| VSCLT = 1 | 4:0 | R/W | 00000   | 4.3V to 3.3V in 50 mV decrements                            |               |               |               |
|           |     |     |         | 00000 = 4.25V   | 01000 = 3.85V | 10000 = 3.45V | 11000 = 3.25V |
|           |     |     |         | 00001 = 4.20V   | 01001 = 3.80V | 10001 = 3.40V | 11001 = 3.25V |
|           |     |     |         | 00010 = 4.15V   | 01010 = 3.75V | 10010 = 3.35V | 11010 = 3.25V |
|           |     |     |         | 00011 = 4.10V   | 01011 = 3.70V | 10011 = 3.30V | 11011 = 3.25V |
|           |     |     |         | 00100 = 4.05V   | 01100 = 3.65V | 10100 = 3.25V | 11100 = 3.25V |
|           |     |     |         | 00101 = 4.00V   | 01101 = 3.60V | 10101 = 3.25V | 11101 = 3.25V |
|           |     |     |         | 00110 = 3.95V   | 01110 = 3.55V | 10110 = 3.25V | 11110 = 3.25V |
|           |     |     |         | 00111 = 3.90V   | 01111 = 3.50V | 10111 = 3.25V | 11111 = 3.25V |

The three most significant bits [7:5] in registers 21'h and 22'h are used to mask the output voltage power-good flag after the start-up sequenced is finished.

**TABLE 8-28: POWER-ON-RESET RISING THRESHOLD VOLTAGE SETTING REGISTER (21'H)**

| Register Name   | PORUP_REG |     |         | Power-on-Reset Rising Threshold |                 |
|-----------------|-----------|-----|---------|---------------------------------|-----------------|
| Address         | —         |     |         | 0x21'h                          |                 |
| Field           | Bit       | R/W | Default | Description                     |                 |
| PORUP           | 4:0       | R/W | 01011   | See <a href="#">Table 8-27</a>  |                 |
| PGOOD_MASK<br>1 | 5         | R/W | 1       | 0 = Do not mask PGOOD1          | 1 = Mask PGOOD1 |
| PGOOD_MASK<br>2 | 6         | R/W | 1       | 0 = Do not mask PGOOD2          | 1 = Mask PGOOD2 |
| PGOOD_MASK<br>3 | 7         | R/W | 1       | 0 = Do not mask PGOOD3          | 1 = Mask PGOOD3 |

**TABLE 8-29: POWER-ON-RESET FALLING THRESHOLD VOLTAGE SETTING REGISTER (22'H)**

| Register Name   | PORDN_REG |     |         | Power-on-Reset Falling Threshold |                 |
|-----------------|-----------|-----|---------|----------------------------------|-----------------|
| Address         | —         |     |         | 0x22'h                           |                 |
| Field           | Bit       | R/W | Default | Description                      |                 |
| PORDN           | 4:0       | R/W | 01101   | See <a href="#">Table 8-27</a>   |                 |
| PGOOD_MASK<br>4 | 5         | R/W | 1       | 0 = Do not mask PGOOD4           | 1 = Mask PGOOD4 |
| PGOOD_MASK<br>5 | 6         | R/W | 1       | 0 = Do not mask PGOOD5           | 1 = Mask PGOOD5 |
| PGOOD_MASK<br>6 | 7         | R/W | 1       | 0 = Do not mask PGOOD6           | 1 = Mask PGOOD6 |

# MIC7400

## 8.16 Pull-Down When Disabled Register (23'h)

This register is used to set the preference of enabling/disabling a pull-down FET when the DC/DC regulators are disabled. The pull-down value for buck regulators 1 through 5 is 90Ω. The pull-down current value for the boost regulator 6 is programmable.

**TABLE 8-30: PULL-DOWN WHEN DISABLED REGISTER**

| Register Name | PULLDN1-6_REG |     |         | Pull-Down When Disabled Register  |
|---------------|---------------|-----|---------|---|
| Address       | —             |     |         | 0x23'h  |
| Field         | Bit           | R/W | Default | Description   |
| PULLD1        | 0             | R/W | 0       | Enable/Disable the pull-down on Regulator 1 when power down.<br>0 = No Pull-Down; 1 = Pull-Down |
| PULLD2        | 1             | R/W | 0       | Enable/Disable the pull-down on Regulator 2 when power down.<br>0 = No Pull-Down; 1 = Pull-Down |
| PULLD3        | 2             | R/W | 0       | Enable/Disable the pull-down on Regulator 3 when power down.<br>0 = No Pull-Down; 1 = Pull-Down |
| PULLD4        | 3             | R/W | 0       | Enable/Disable the pull-down on Regulator 4 when power down.<br>0 = No Pull-Down; 1 = Pull-Down |
| PULLD5        | 4             | R/W | 0       | Enable/Disable the pull-down on Regulator 5 when power down.<br>0 = No Pull-Down; 1 = Pull-Down |
| PULLD6C       | 6:5           | R/W | 00      | Sets Boost Pull-Down Current Level<br>00 = 148 mA; 01 = 111 mA; 10 = 74 mA; 11 = 37 mA          |
| PULLD6        | 7             | R/W | 0       | Enable/Disable the pull-down on Regulator 6 when power down.<br>0 = No Pull-Down; 1 = Pull-Down |

## 8.17 Internal Clock Control Register

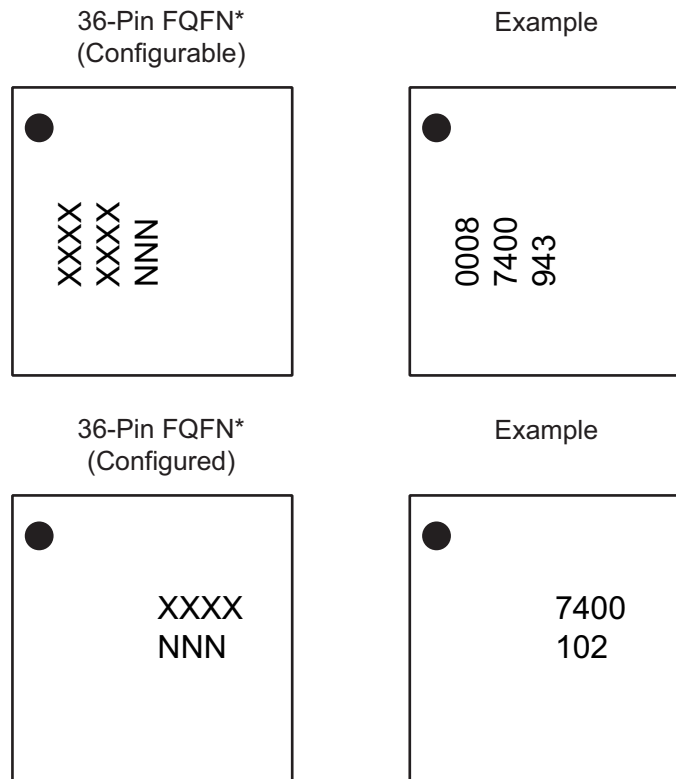
This register houses the Force\_CLK\_ON bit 2 used when sending the special commands keys. Bit 2 of this register is used to set the PMIC clock to permanently be enabled in order to execute the new command. This bit should be cleared after the command has been executed in order to save power (the internal clock logic will shut down the clock automatically when not needed).

**TABLE 8-31: INTERNAL CLOCK CONTROL REGISTER**

| Register Name    | Force Clock Register |     |         | Internal Clock Control Register  |
|------------------|----------------------|-----|---------|--|
| Address          | —                    |     |         | 0x2F'h   |
| Field            | Bit                  | R/W | Default | Description  |
| —                | 0                    | R/W | 0       | Reserved   |
| —                | 1                    | R/W | 0       | Reserved   |
| FORCE_<br>CLK_ON | 2                    | R/W | 0       | 0=No action.<br>1= Force the internal clock to keep running and not be turned off by the power down logic. |
| —                | 3                    | R/W | 0       | Reserved   |
| —                | 4                    | R/W | 0       | Reserved   |
| —                | 5                    | R/W | 0       | Reserved   |
| —                | 6                    | R/W | 0       | Reserved   |
| —                | 7                    | R/W | 0       | Reserved   |

## 9.0 PACKAGING INFORMATION

### 9.1 Package Marking Information



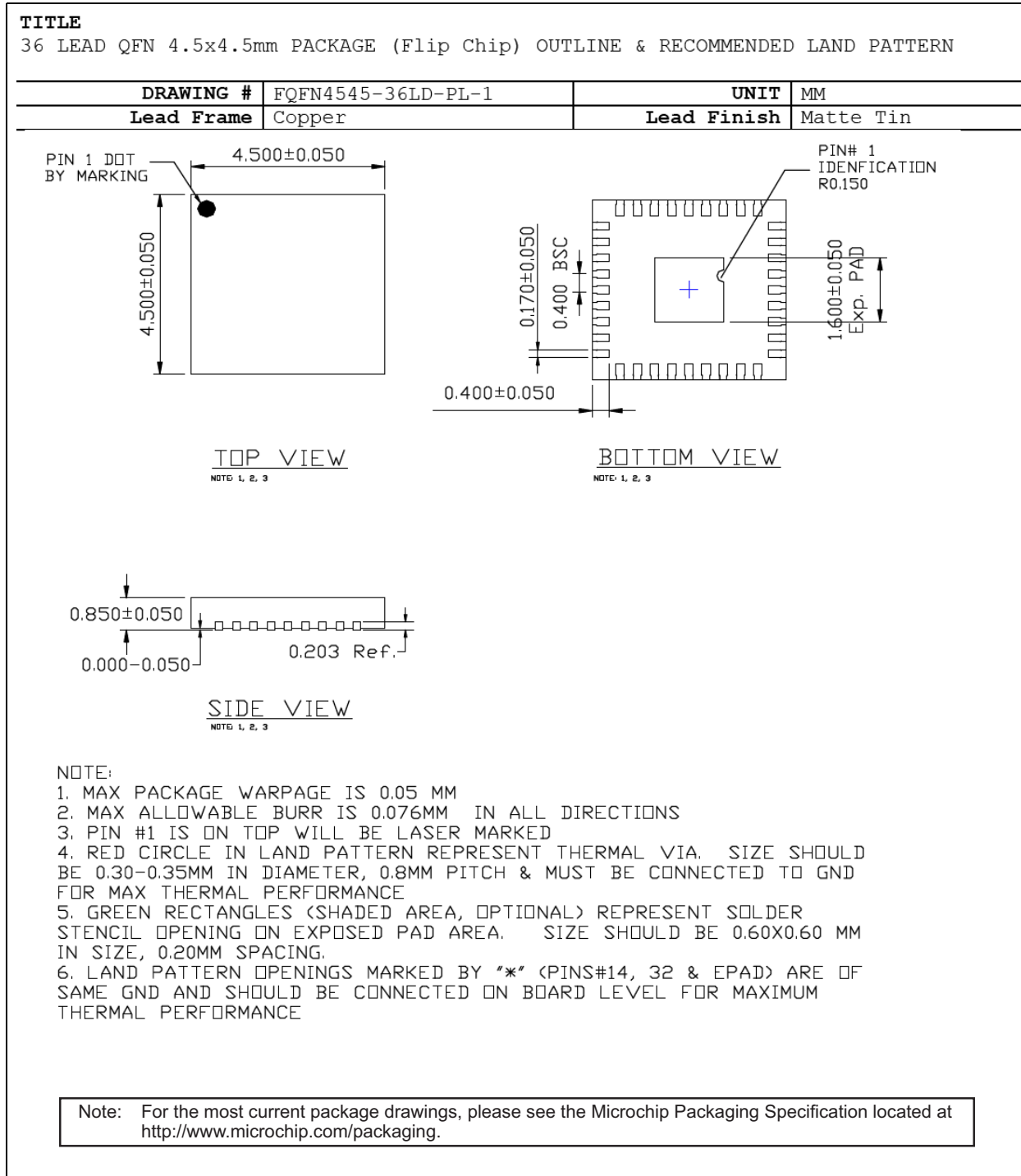
|   |
|---|
| <p><b>Legend:</b></p> <p>XX...X Product code or customer-specific information</p> <p>Y Year code (last digit of calendar year)</p> <p>YY Year code (last 2 digits of calendar year)</p> <p>WW Week code (week of January 1 is week '01')</p> <p>NNN Alphanumeric traceability code</p> <p>(e3) Pb-free JEDEC® designator for Matte Tin (Sn)</p> <p>* This package is Pb-free. The Pb-free JEDEC designator ((e3)) can be found on the outer packaging for this package.</p> <p>•, ▲, ▼ Pin one index is identified by a dot, delta up, or delta down (triangle mark).</p> |
|---|

**Note:** In the event the full Microchip part number cannot be marked on one line, it will be carried over to the next line, thus limiting the number of available characters for customer-specific information. Package may or may not include the corporate logo.

Underbar ( ) and/or Overbar ( ) symbol may not be to scale.

# MIC7400

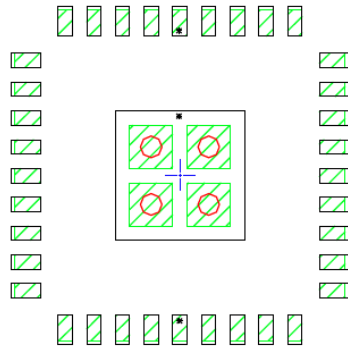
## 36-Lead 4.5 mm x 4.5 mm FQFN Package Outline and Recommended Land Pattern



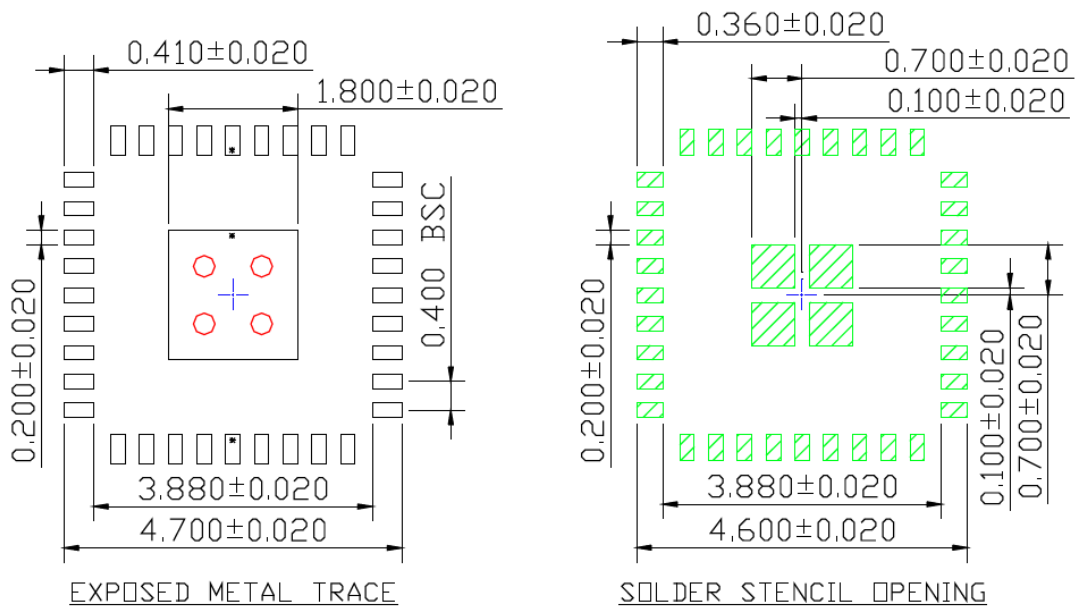
## POD-Land Pattern drawing #FQFN4545-36LD-PL-1

### RECOMMENDED LAND PATTERN

NOTE: 4, 5, 6



### STACKED-UP



Note: For the most current package drawings, please see the Microchip Packaging Specification located at <http://www.microchip.com/packaging>.

# MIC7400

---

NOTES:



## APPENDIX A: REVISION HISTORY

### Revision A (November 2017)

- Converted Micrel document MIC7400 to Microchip data sheet DS20005887A.
- Minor text changes throughout.

# MIC7400

---

NOTES:

## PRODUCT IDENTIFICATION SYSTEM

To order or obtain information, e.g., on pricing or delivery, contact your local Microchip representative or sales office.

| <u>PART NO.</u>   | <u>-XXXX</u>  | <u>X</u>   | <u>XX</u>   | <u>-XX</u>   |
|---|---|--|---|--|
| Device  | Output Voltages   | Junction Temp. Range                                   | Package   | Media Type   |
| <b>Device:</b> MIC7400: Configurable PMIC, Five Channel Buck Regulator Plus One Boost with HyperLight Load® and I <sup>2</sup> C Control  | <b>Output Voltages:</b> <blank>= 1.8V, 1.1V, 1.8V, 1.05V, 1.25V, 12V<br>XXXX = Configurable (Contact Marketing for Options) | <b>Junction Temperature Range:</b> Y = -40°C to +125°C | <b>Package:</b> FL = 36-Lead 4.5 mm x 4.5 mm FQFN | <b>Media Type:</b> <blank>= 1/Tube<br>T5 = 500/Reel<br>TR = 5,000/Reel |
| <b>Examples:</b>  |   |  |   |  |
| a) MIC7400YFL-T5: Configurable PMIC, Five Channel Buck Regulator Plus One Boost with HyperLight Load and I <sup>2</sup> C Control, 1.8V, 1.1V, 1.8V, 1.05V, 1.25V, 12V Output Voltages, -40°C to +125°C Temp. Range, 36-Lead FQFN, 500/Reel   |   |  |   |  |
| b) MIC7400-XXXXYFL-TR: Configurable PMIC, Five Channel Buck Regulator Plus One Boost with HyperLight Load and I <sup>2</sup> C Control, Configurable Output Voltages, -40°C to +125°C Temp. Range, 36-Lead FQFN, 5,000/Reel   |   |  |   |  |
| c) MIC7400YFL: Configurable PMIC, Five Channel Buck Regulator Plus One Boost with HyperLight Load and I <sup>2</sup> C Control, 1.8V, 1.1V, 1.8V, 1.05V, 1.25V, 12V Output Voltages, -40°C to +125°C Temp. Range, 36-Lead FQFN, 1/Tube  |   |  |   |  |
| d) MIC7400-XXXXYFL-T5: Configurable PMIC, Five Channel Buck Regulator Plus One Boost with HyperLight Load and I <sup>2</sup> C Control, Configurable Output Voltages, -40°C to +125°C Temp. Range, 36-Lead FQFN, 500/Reel   |   |  |   |  |
| <b>Note 1:</b> Tape and Reel identifier only appears in the catalog part number description. This identifier is used for ordering purposes and is not printed on the device package. Check with your Microchip Sales Office for package availability with the Tape and Reel option. |   |  |   |  |

# MIC7400

---

NOTES:

---

---

**Note the following details of the code protection feature on Microchip devices:**

- Microchip products meet the specification contained in their particular Microchip Data Sheet.
- Microchip believes that its family of products is one of the most secure families of its kind on the market today, when used in the intended manner and under normal conditions.
- There are dishonest and possibly illegal methods used to breach the code protection feature. All of these methods, to our knowledge, require using the Microchip products in a manner outside the operating specifications contained in Microchip's Data Sheets. Most likely, the person doing so is engaged in theft of intellectual property.
- Microchip is willing to work with the customer who is concerned about the integrity of their code.
- Neither Microchip nor any other semiconductor manufacturer can guarantee the security of their code. Code protection does not mean that we are guaranteeing the product as “unbreakable.”

Code protection is constantly evolving. We at Microchip are committed to continuously improving the code protection features of our products. Attempts to break Microchip's code protection feature may be a violation of the Digital Millennium Copyright Act. If such acts allow unauthorized access to your software or other copyrighted work, you may have a right to sue for relief under that Act.

---

Information contained in this publication regarding device applications and the like is provided only for your convenience and may be superseded by updates. It is your responsibility to ensure that your application meets with your specifications. MICROCHIP MAKES NO REPRESENTATIONS OR WARRANTIES OF ANY KIND WHETHER EXPRESS OR IMPLIED, WRITTEN OR ORAL, STATUTORY OR OTHERWISE, RELATED TO THE INFORMATION, INCLUDING BUT NOT LIMITED TO ITS CONDITION, QUALITY, PERFORMANCE, MERCHANTABILITY OR FITNESS FOR PURPOSE. Microchip disclaims all liability arising from this information and its use. Use of Microchip devices in life support and/or safety applications is entirely at the buyer's risk, and the buyer agrees to defend, indemnify and hold harmless Microchip from any and all damages, claims, suits, or expenses resulting from such use. No licenses are conveyed, implicitly or otherwise, under any Microchip intellectual property rights unless otherwise stated.

*Microchip received ISO/TS-16949:2009 certification for its worldwide headquarters, design and wafer fabrication facilities in Chandler and Tempe, Arizona; Gresham, Oregon and design centers in California and India. The Company's quality system processes and procedures are for its PIC® MCUs and dsPIC® DSCs, KEELOQ® code hopping devices, Serial EEPROMs, microperipherals, nonvolatile memory and analog products. In addition, Microchip's quality system for the design and manufacture of development systems is ISO 9001:2000 certified.*

**QUALITY MANAGEMENT SYSTEM  
CERTIFIED BY DNV  
= ISO/TS 16949 =**

### Trademarks

The Microchip name and logo, the Microchip logo, AnyRate, AVR, AVR logo, AVR Freaks, BeaconThings, BitCloud, CryptoMemory, CryptoRF, dsPIC, FlashFlex, flexPWR, Helder, JukeBlox, KEELOQ, KEELOQ logo, Klear, LANCheck, LINK MD, maXStylus, maXTouch, MediaLB, megaAVR, MOST, MOST logo, MPLAB, OptoLyzer, PIC, picoPower, PICSTART, PIC32 logo, Prochip Designer, QTouch, RightTouch, SAM-BA, SpyNIC, SST, SST Logo, SuperFlash, tinyAVR, UNI/O, and XMEGA are registered trademarks of Microchip Technology Incorporated in the U.S.A. and other countries.

ClockWorks, The Embedded Control Solutions Company, EtherSynch, Hyper Speed Control, HyperLight Load, IntelliMOS, mTouch, Precision Edge, and Quiet-Wire are registered trademarks of Microchip Technology Incorporated in the U.S.A.

Adjacent Key Suppression, AKS, Analog-for-the-Digital Age, Any Capacitor, AnyIn, AnyOut, BodyCom, chipKIT, chipKIT logo, CodeGuard, CryptoAuthentication, CryptoCompanion, CryptoController, dsPICDEM, dsPICDEM.net, Dynamic Average Matching, DAM, ECAN, EtherGREEN, In-Circuit Serial Programming, ICSP, Inter-Chip Connectivity, JitterBlocker, KlearNet, KlearNet logo, Mindi, MiWi, motorBench, MPASM, MPF, MPLAB Certified logo, MPLIB, MPLINK, MultiTRAK, NetDetach, Omniscient Code Generation, PICDEM, PICDEM.net, PICKit, PICtail, PureSilicon, QMatrix, RightTouch logo, REAL ICE, Ripple Blocker, SAM-ICE, Serial Quad I/O, SMART-I.S., SQI, SuperSwitcher, SuperSwitcher II, Total Endurance, TSHARC, USBCheck, VariSense, ViewSpan, WiperLock, Wireless DNA, and ZENA are trademarks of Microchip Technology Incorporated in the U.S.A. and other countries.

SQTP is a service mark of Microchip Technology Incorporated in the U.S.A.

Silicon Storage Technology is a registered trademark of Microchip Technology Inc. in other countries.

GestIC is a registered trademark of Microchip Technology Germany II GmbH & Co. KG, a subsidiary of Microchip Technology Inc., in other countries.

All other trademarks mentioned herein are property of their respective companies.

© 2017, Microchip Technology Incorporated, All Rights Reserved.  
ISBN: 978-1-5224-2382-9



# MICROCHIP

## Worldwide Sales and Service

### AMERICAS

**Corporate Office**  
2355 West Chandler Blvd.  
Chandler, AZ 85224-6199  
Tel: 480-792-7200  
Fax: 480-792-7277  
Technical Support:  
<http://www.microchip.com/support>  
Web Address:  
[www.microchip.com](http://www.microchip.com)

**Atlanta**  
Duluth, GA  
Tel: 678-957-9614  
Fax: 678-957-1455

**Austin, TX**  
Tel: 512-257-3370

**Boston**  
Westborough, MA  
Tel: 774-760-0087  
Fax: 774-760-0088

**Chicago**  
Itasca, IL  
Tel: 630-285-0071  
Fax: 630-285-0075

**Dallas**  
Addison, TX  
Tel: 972-818-7423  
Fax: 972-818-2924

**Detroit**  
Novi, MI  
Tel: 248-848-4000

**Houston, TX**  
Tel: 281-894-5983

**Indianapolis**  
Noblesville, IN  
Tel: 317-773-8323  
Fax: 317-773-5453  
Tel: 317-536-2380

**Los Angeles**  
Mission Viejo, CA  
Tel: 949-462-9523  
Fax: 949-462-9608  
Tel: 951-273-7800

**Raleigh, NC**  
Tel: 919-844-7510

**New York, NY**  
Tel: 631-435-6000

**San Jose, CA**  
Tel: 408-735-9110  
Tel: 408-436-4270

**Canada - Toronto**  
Tel: 905-695-1980  
Fax: 905-695-2078

### ASIA/PACIFIC

**Asia Pacific Office**  
Suites 3707-14, 37th Floor  
Tower 6, The Gateway  
Harbour City, Kowloon

**Hong Kong**  
Tel: 852-2943-5100  
Fax: 852-2401-3431

**Australia - Sydney**  
Tel: 61-2-9868-6733  
Fax: 61-2-9868-6755

**China - Beijing**  
Tel: 86-10-8569-7000  
Fax: 86-10-8528-2104

**China - Chengdu**  
Tel: 86-28-8665-5511  
Fax: 86-28-8665-7889

**China - Chongqing**  
Tel: 86-23-8980-9588  
Fax: 86-23-8980-9500

**China - Dongguan**  
Tel: 86-769-8702-9880

**China - Guangzhou**  
Tel: 86-20-8755-8029

**China - Hangzhou**  
Tel: 86-571-8792-8115  
Fax: 86-571-8792-8116

**China - Hong Kong SAR**  
Tel: 852-2943-5100  
Fax: 852-2401-3431

**China - Nanjing**  
Tel: 86-25-8473-2460  
Fax: 86-25-8473-2470

**China - Qingdao**  
Tel: 86-532-8502-7355  
Fax: 86-532-8502-7205

**China - Shanghai**  
Tel: 86-21-3326-8000  
Fax: 86-21-3326-8021

**China - Shenyang**  
Tel: 86-24-2334-2829  
Fax: 86-24-2334-2393

**China - Shenzhen**  
Tel: 86-755-8864-2200  
Fax: 86-755-8203-1760

**China - Wuhan**  
Tel: 86-27-5980-5300  
Fax: 86-27-5980-5118

**China - Xian**  
Tel: 86-29-8833-7252  
Fax: 86-29-8833-7256

### ASIA/PACIFIC

**China - Xiamen**  
Tel: 86-592-2388138  
Fax: 86-592-2388130

**China - Zhuhai**  
Tel: 86-756-3210040  
Fax: 86-756-3210049

**India - Bangalore**  
Tel: 91-80-3090-4444  
Fax: 91-80-3090-4123

**India - New Delhi**  
Tel: 91-11-4160-8631  
Fax: 91-11-4160-8632

**India - Pune**  
Tel: 91-20-3019-1500

**Japan - Osaka**  
Tel: 81-6-6152-7160  
Fax: 81-6-6152-9310

**Japan - Tokyo**  
Tel: 81-3-6880-3770  
Fax: 81-3-6880-3771

**Korea - Daegu**  
Tel: 82-53-744-4301  
Fax: 82-53-744-4302

**Korea - Seoul**  
Tel: 82-2-554-7200  
Fax: 82-2-558-5932 or  
82-2-558-5934

**Malaysia - Kuala Lumpur**  
Tel: 60-3-6201-9857  
Fax: 60-3-6201-9859

**Malaysia - Penang**  
Tel: 60-4-227-8870  
Fax: 60-4-227-4068

**Philippines - Manila**  
Tel: 63-2-634-9065  
Fax: 63-2-634-9069

**Singapore**  
Tel: 65-6334-8870  
Fax: 65-6334-8850

**Taiwan - Hsin Chu**  
Tel: 886-3-5778-366  
Fax: 886-3-5770-955

**Taiwan - Kaohsiung**  
Tel: 886-7-213-7830

**Taiwan - Taipei**  
Tel: 886-2-2508-8600  
Fax: 886-2-2508-0102

**Thailand - Bangkok**  
Tel: 66-2-694-1351  
Fax: 66-2-694-1350

### EUROPE

**Austria - Wels**  
Tel: 43-7242-2244-39  
Fax: 43-7242-2244-393

**Denmark - Copenhagen**  
Tel: 45-4450-2828  
Fax: 45-4485-2829

**Finland - Espoo**  
Tel: 358-9-4520-820

**France - Paris**  
Tel: 33-1-69-53-63-20  
Fax: 33-1-69-30-90-79

**France - Saint Cloud**  
Tel: 33-1-30-60-70-00

**Germany - Garching**  
Tel: 49-8931-9700

**Germany - Haan**  
Tel: 49-2129-3766400

**Germany - Heilbronn**  
Tel: 49-7131-67-3636

**Germany - Karlsruhe**  
Tel: 49-721-625370

**Germany - Munich**  
Tel: 49-89-627-144-0  
Fax: 49-89-627-144-44

**Germany - Rosenheim**  
Tel: 49-8031-354-560

**Israel - Ra'anana**  
Tel: 972-9-744-7705

**Italy - Milan**  
Tel: 39-0331-742611  
Fax: 39-0331-466781

**Italy - Padova**  
Tel: 39-049-7625286

**Netherlands - Drunen**  
Tel: 31-416-690399  
Fax: 31-416-690340

**Norway - Trondheim**  
Tel: 47-7289-7561

**Poland - Warsaw**  
Tel: 48-22-3325737

**Romania - Bucharest**  
Tel: 40-21-407-87-50

**Spain - Madrid**  
Tel: 34-91-708-08-90  
Fax: 34-91-708-08-91

**Sweden - Gothenberg**  
Tel: 46-31-704-60-40

**Sweden - Stockholm**  
Tel: 46-8-5090-4654

**UK - Wokingham**  
Tel: 44-118-921-5800  
Fax: 44-118-921-5820